



Hornsea Project Four: Environmental Statement (ES)

PINS Document Reference: A6.1.2
APFP Regulation 5(2)(a)

A6.1.2, Volume 6, Annex 1.2: Envirocheck Report – Part Three

Prepared Royal HaskoningDHV, July 2021
Checked Royal HaskoningDHV, July 2021
Accepted Ant Sahota, Orsted, August 2021
Approved Julian Carolan, Orsted, September 2021

A6.1.2
Version B

Table of Contents

1	Introduction.....	3
1.1	Project Background.....	3
1.2	Data Limitations.....	3
2	Landfall Maps.....	5
3	Onshore Export Cable Corridor Maps – Section One.....	32
4	Onshore Export Cable Corridor Maps – Section Two	332
5	Onshore Export Cable Corridor Maps – Section Three.....	519
6	Onshore Export Cable Corridor Maps – Section Four	767
7	Onshore Export Cable Corridor Maps – Section Five	1050
8	Onshore Substation Maps – Section One.....	1274
9	Onshore Substation Maps – Section Two	1448

List of Figures

Figure 1: Envirocheck Study Area	4
--	---

4 Onshore Export Cable Corridor Maps – Section Two

Street View

Published 2019

Source map scale - 1:10,000

Street View is a street-level map for the whole of Great Britain produced by the Ordnance Survey. These maps are provided at a nominal scale of 1:10,000

Map Name(s) and Date(s)



Street View Map - Slice B

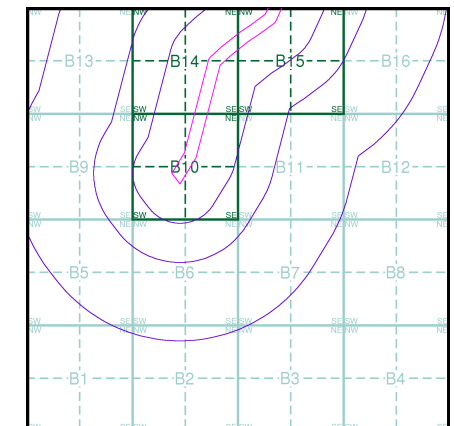

Order Details

Order Number: 201127465_1_1
Customer Ref: PB8783-103-105
National Grid Reference: 505970, 451130
Slice: B
Site Area (Ha): 72.
Search Buffer (m): 1000

Site Details

Hornsea Route

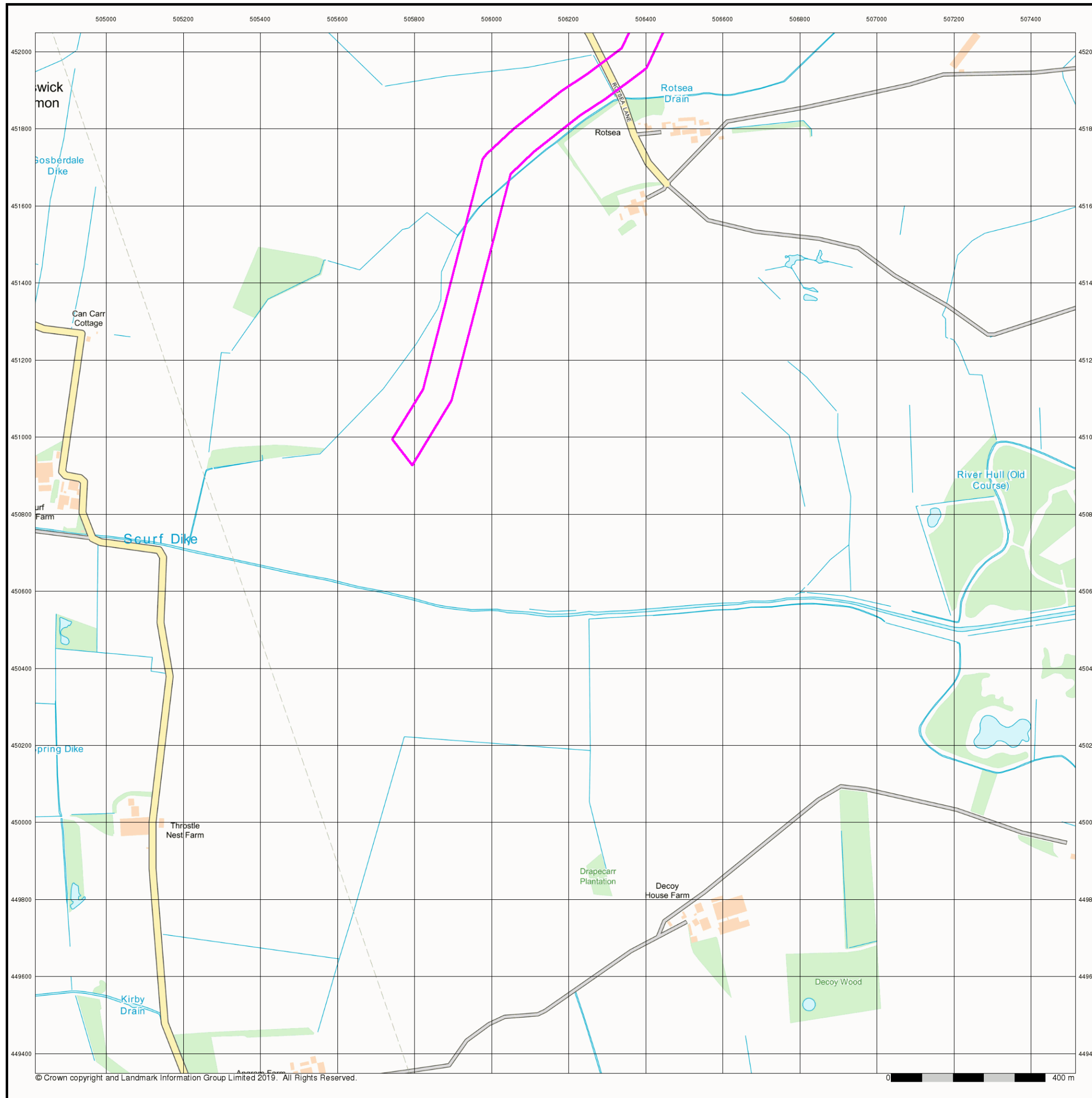

Historical Mapping Legends

Ordnance Survey County Series 1:10,560

	Gravel Pit		Sand Pit		Other Pits
	Quarry		Shingle		Orchard
	Osiers		Reeds		Marsh
	Mixed Wood		Deciduous		Brushwood
	Fir		Furze		Rough Pasture
	Arrow denotes flow of water		Trigonometrical Station		
	Site of Antiquities		Bench Mark		
	Pump, Guide Post, Signal Post		Well, Spring, Boundary Post		
	-285 Surface Level				
	Sketched Contour		Instrumental Contour		
	Main Roads		Minor Roads		
	Sunken Road		Raised Road		
	Road over Railway		Railway over River		
	Railway over Road		Level Crossing		
	Road over River or Canal		Road over Stream		
	Road over Stream				
	County Boundary (Geographical)				
	County & Civil Parish Boundary				
	Administrative County & Civil Parish Boundary				
	County Borough Boundary (England)				
	County Burgh Boundary (Scotland)				
	Rural District Boundary				
	Civil Parish Boundary				

Ordnance Survey Plan 1:10,000

	Chalk Pit, Clay Pit or Quarry		Gravel Pit
	Sand Pit		Disused Pit or Quarry
	Refuse or Slag Heap		Lake, Loch or Pond
	Dunes		Boulders
	Coniferous Trees		Non-Coniferous Trees
	Orchard		Scrub
	Coppice		Heath
	Rough Grassland		Marsh
	Reeds		Saltings
	Building		Glasshouse
	Sloping Masonry		Pylon
	Electricity Transmission Line		Pole
	Cutting		Embankment
	Standard Gauge Multiple Track		Standard Gauge Single Track
	Siding, Tramway or Mineral Line		Narrow Gauge
	Geographical County		
	Administrative County, County Borough or County of City		
	Municipal Borough, Urban or Rural District, Burgh or District Council		
	Borough, Burgh or County Constituency Shown only when not coincident with other boundaries		
	Civil Parish Shown alternately when coincidence of boundaries occurs		
	BP, BS Boundary Post or Stone		Pol Sta Police Station
	Ch Church		PO Post Office
	CH Club House		PC Public Convenience
	F E Sta Fire Engine Station		PH Public House
	FB Foot Bridge		SB Signal Box
	Fn Fountain		Spr Spring
	GP Guide Post		TCB Telephone Call Box
	MP Mile Post		TCP Telephone Call Post
	MS Mile Stone		W Well

1:10,000 Raster Mapping

	Gravel Pit		Refuse tip or slag heap
	Rock		Rock (scattered)
	Boulders		Boulders (scattered)
	Shingle		Mud
	Sand		Sand Pit
	Slopes		Top of cliff
	General detail		Underground detail
	Overhead detail		Narrow gauge railway
	Multi-track railway		Single track railway
	County boundary (England only)		Civil, parish or community boundary
	District, Unitary, Metropolitan, London Borough boundary		Constituency boundary
	Area of wooded vegetation		Non-coniferous trees
	Non-coniferous trees (scattered)		Coniferous trees
	Coniferous trees (scattered)		Positioned tree
	Orchard		Coppice or Osiers
	Rough Grassland		Heath
	Scrub		Marsh, Salt Marsh or Reeds
	Water feature		Flow arrows
	MHW(S) Mean high water (springs)		MLW(S) Mean low water (springs)
	Telephone line (where shown)		Electricity transmission line (with poles)
	Bench mark (where shown)		Triangulation station
	Point feature (e.g. Guide Post or Mile Stone)		Pylon, flare stack or lighting tower
	Site of (antiquity)		Glasshouse
	General Building		Important Building

Envirocheck®

LANDMARK INFORMATION GROUP®

Historical Mapping & Photography included:

Mapping Type	Scale	Date	Pg
Yorkshire	1:10,560	1855	2
Yorkshire	1:10,560	1892	3
Yorkshire	1:10,560	1911	4
Yorkshire	1:10,560	1951	5
Ordnance Survey Plan	1:10,000	1956	6
Ordnance Survey Plan	1:10,000	1975	7
Ordnance Survey Plan	1:10,000	1983	8
Ordnance Survey Plan	1:10,000	1994	9
10K Raster Mapping	1:10,000	1999	10
Street View	Variable		11

Historical Map - Slice B

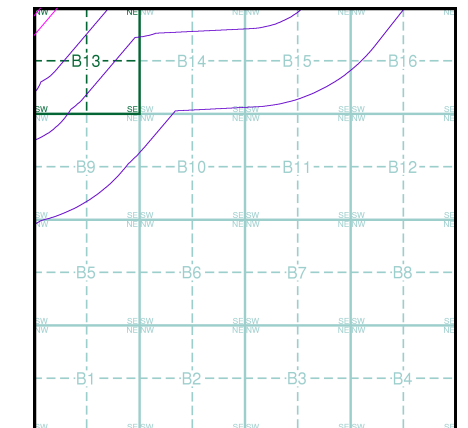

Order Details

Order Number: 201127555_1_1
 Customer Ref: PB8783-103-105
 National Grid Reference: 502940, 446720
 Slice: B
 Site Area (Ha): 62.79
 Search Buffer (m): 1000

Site Details

Hornsea Route

Landmark
 INFORMATION GROUP

Tel: 0844 844 9952
 Fax: 0844 844 9951
 Web: www.envirocheck.co.uk

Yorkshire

Published 1855

Source map scale - 1:10,560

The historical maps shown were reproduced from maps predominantly held at the scale adopted for England, Wales and Scotland in the 1840's. In 1854 the 1:2,500 scale was adopted for mapping urban areas; these maps were used to update the 1:10,560 maps. The published date given therefore is often some years later than the surveyed date. Before 1938, all OS maps were based on the Cassini Projection, with independent surveys of a single county or group of counties, giving rise to significant inaccuracies in outlying areas. In the late 1940's, a Provisional Edition was produced, which updated the 1:10,560 mapping from a number of sources. The maps appear unfinished - with all military camps and other strategic sites removed. These maps were initially overprinted with the National Grid. In 1970, the first 1:10,000 maps were produced using the Transverse Mercator Projection. The revision process continued until recently, with new editions appearing every 10 years or so for urban areas.

Map Name(s) and Date(s)

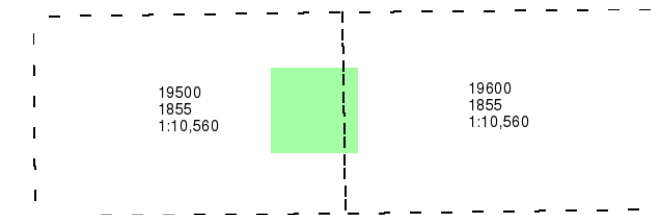

Historical Map - Slice B

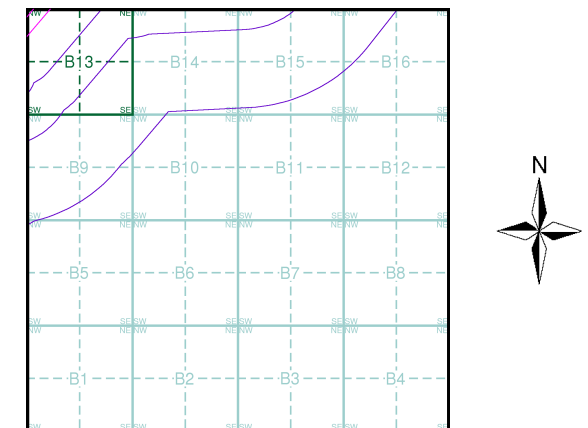

Order Details

Order Number: 201127555_1_1
 Customer Ref: PB8783-103-105
 National Grid Reference: 502940, 446720
 Slice: B
 Site Area (Ha): 62.79
 Search Buffer (m): 1000

Site Details

Hornsea Route

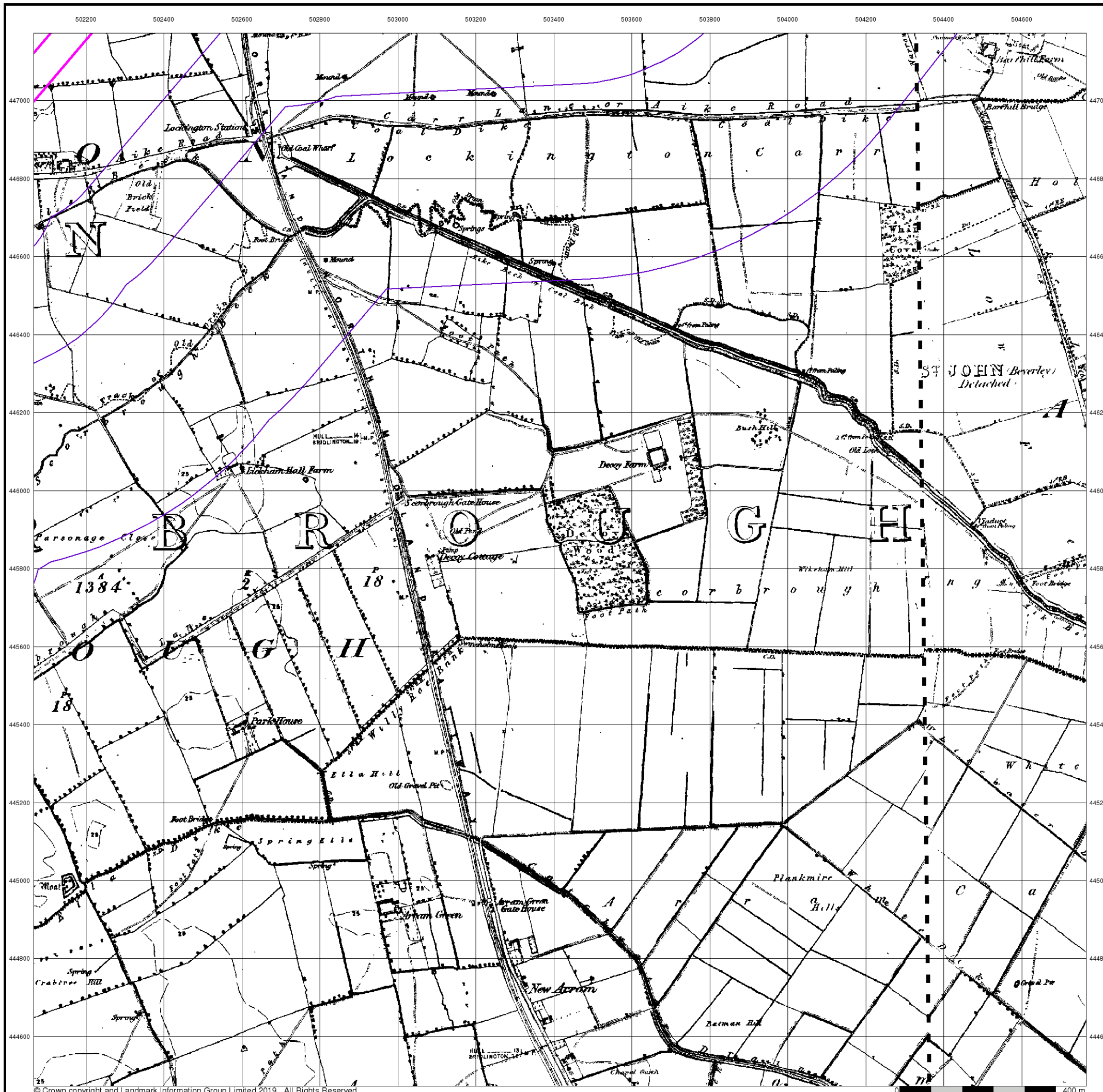

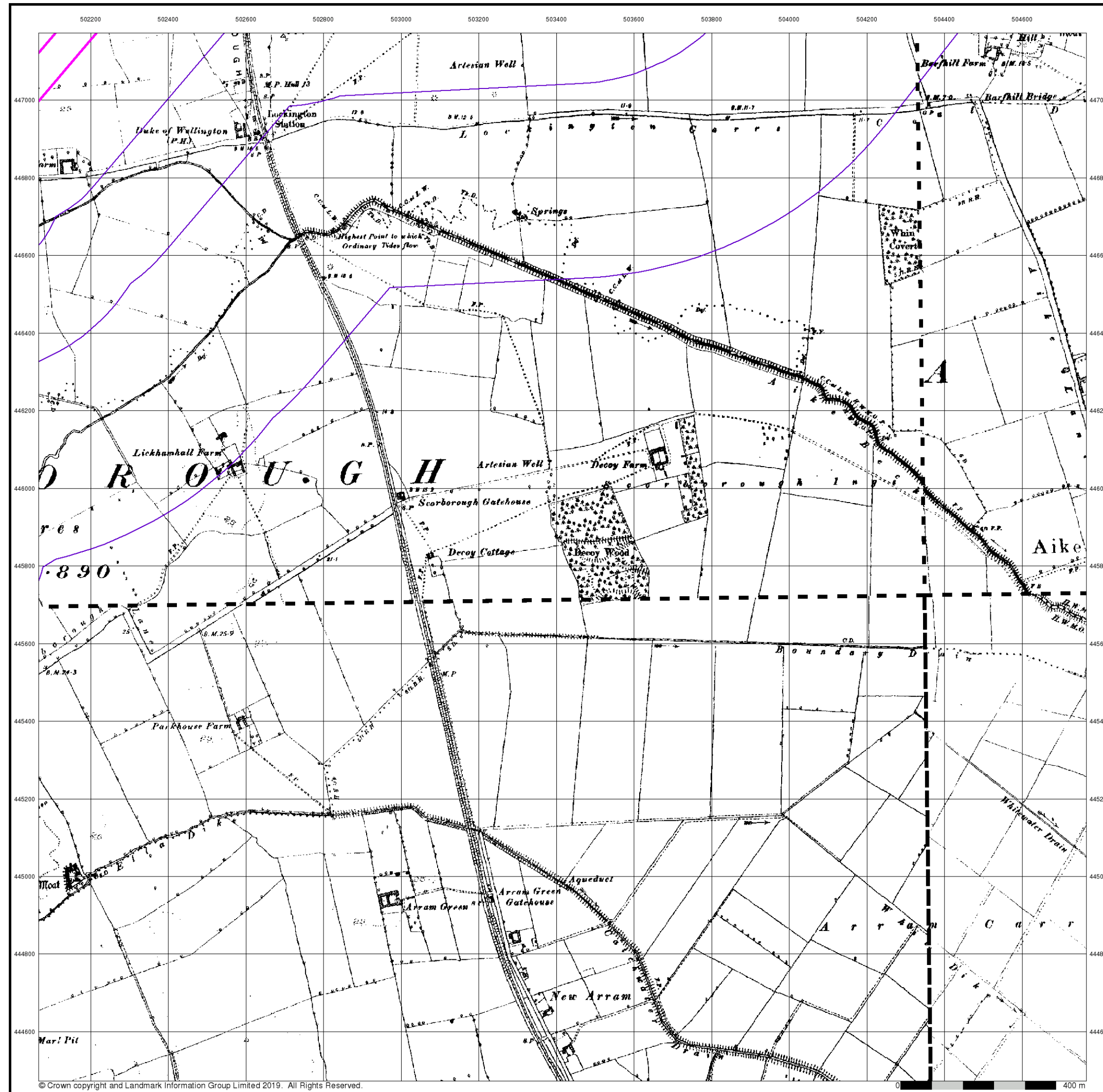

The historical maps shown were reproduced from maps predominantly held at the scale adopted for England, Wales and Scotland in the 1840's. In 1854 the 1:2,500 scale was adopted for mapping urban areas; these maps were used to update the 1:10,560 maps. The published date given therefore is often some years later than the surveyed date. Before 1938, all OS maps were based on the Cassini Projection, with independent surveys of a single county or group of counties, giving rise to significant inaccuracies in outlying areas. In the late 1940's, a Provisional Edition was produced, which updated the 1:10,560 mapping from a number of sources. The maps appear unfinished - with all military camps and other strategic sites removed. These maps were initially overprinted with the National Grid. In 1970, the first 1:10,000 maps were produced using the Transverse Mercator Projection. The revision process continued until recently, with new editions appearing every 10 years or so for urban areas.

Map Name(s) and Date(s)

195NE 1892 1:10,560	196NW 1892 1:10,560
195SE 1892 1:10,560	196SW 1892 1:10,560

Historical Map - Slice B

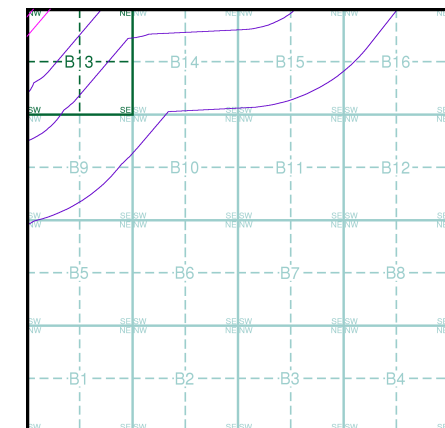

Order Details

Order Number: 201127555_1_1
 Customer Ref: PB8783-103-105
 National Grid Reference: 502940, 446720
 Slice: B
 Site Area (Ha): 62.79
 Search Buffer (m): 1000

Site Details

Hornsea Route

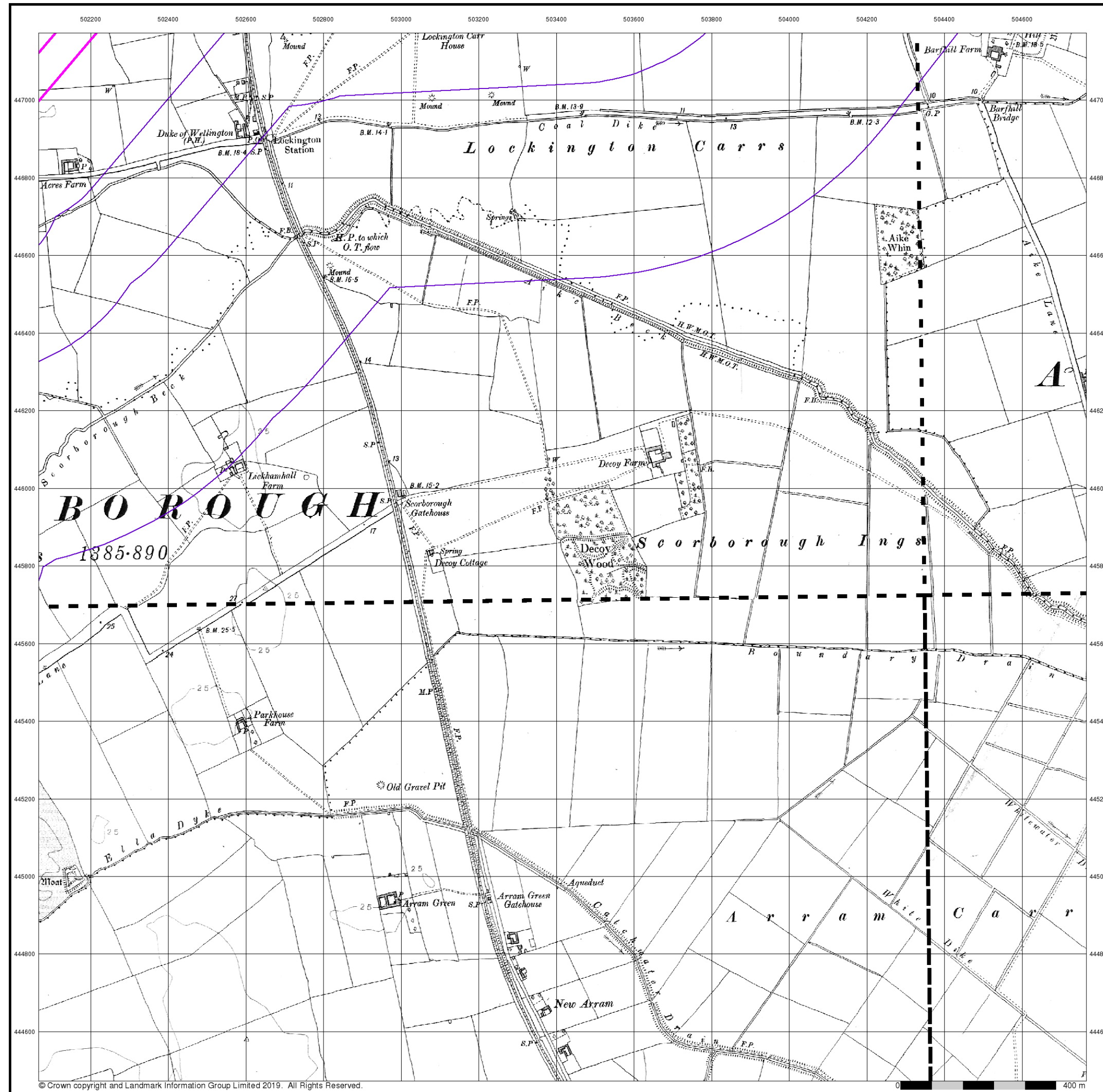

The historical maps shown were reproduced from maps predominantly held at the scale adopted for England, Wales and Scotland in the 1840's. In 1854 the 1:2,500 scale was adopted for mapping urban areas; these maps were used to update the 1:10,560 maps. The published date given therefore is often some years later than the surveyed date. Before 1938, all OS maps were based on the Cassini Projection, with independent surveys of a single county or group of counties, giving rise to significant inaccuracies in outlying areas. In the late 1940's, a Provisional Edition was produced, which updated the 1:10,560 mapping from a number of sources. The maps appear unfinished - with all military camps and other strategic sites removed. These maps were initially overprinted with the National Grid. In 1970, the first 1:10,000 maps were produced using the Transverse Mercator Projection. The revision process continued until recently, with new editions appearing every 10 years or so for urban areas.

Map Name(s) and Date(s)

195NE 1911 1:10,560	196NW 1911 1:10,560
195SE 1911 1:10,560	196SW 1911 1:10,560

Historical Map - Slice B

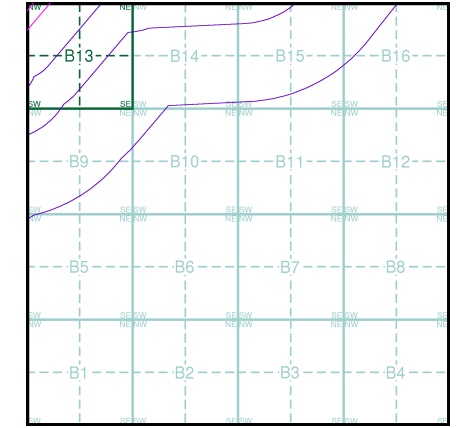

Order Details

Order Number: 201127555_1_1
 Customer Ref: PB8783-103-105
 National Grid Reference: 502940, 446720
 Slice: B
 Site Area (Ha): 62.79
 Search Buffer (m): 1000

Site Details

Hornsea Route

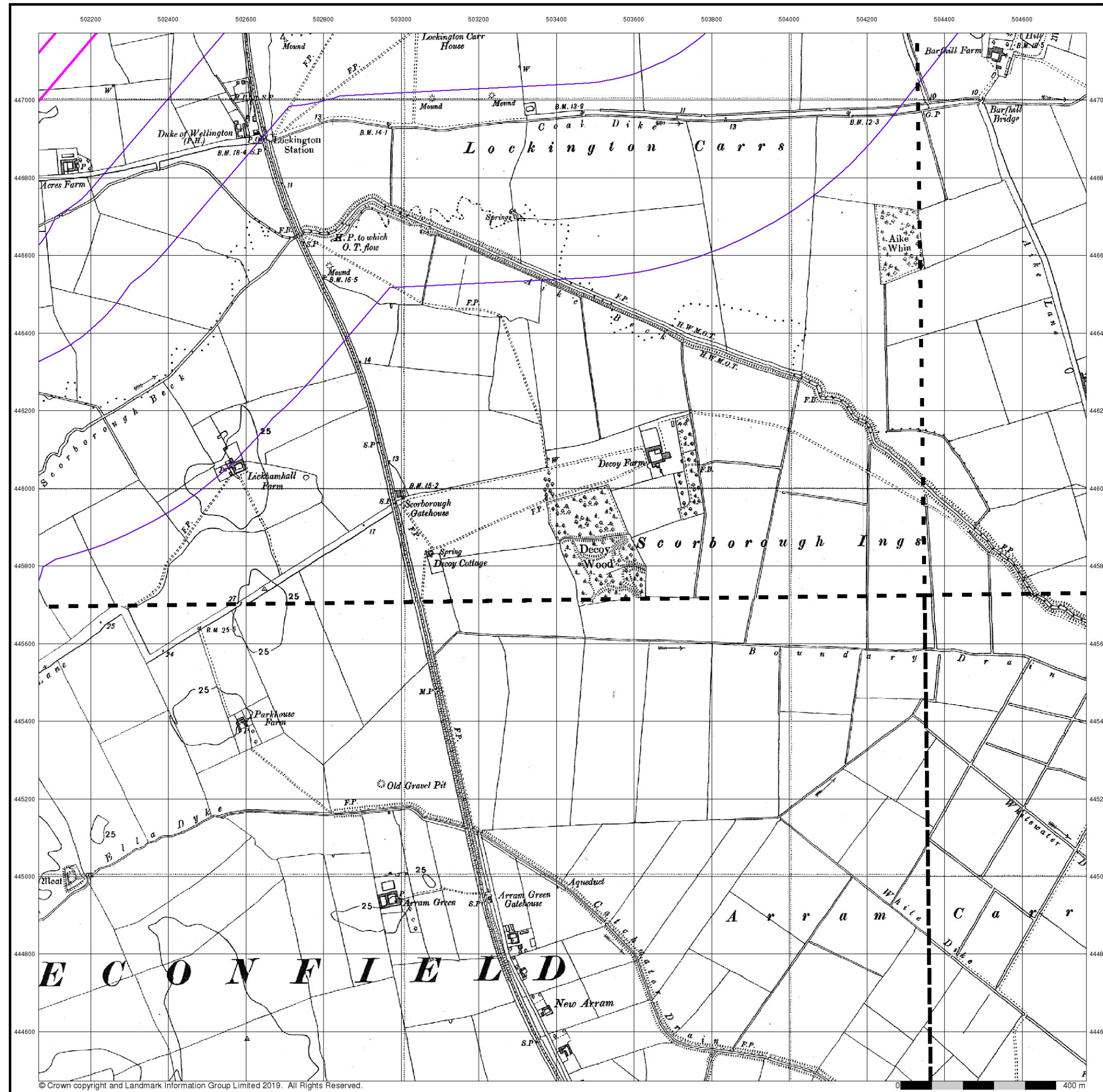

Envirocheck®

LANDMARK INFORMATION GROUP®

Yorkshire

Published 1951

Source map scale - 1:10,560

The historical maps shown were reproduced from maps predominantly held at the scale adopted for England, Wales and Scotland in the 1840's. In 1854 the 1:2,500 scale was adopted for mapping urban areas; these maps were used to update the 1:10,560 maps. The published date given therefore is often some years later than the surveyed date. Before 1938, all OS maps were based on the Cassini Projection, with independent surveys of a single county or group of counties, giving rise to significant inaccuracies in outlying areas. In the late 1940's, a Provisional Edition was produced, which updated the 1:10,560 mapping from a number of sources. The maps appear unfinished - with all military camps and other strategic sites removed. These maps were initially overprinted with the National Grid. In 1970, the first 1:10,000 maps were produced using the Transverse Mercator Projection. The revision process continued until recently, with new editions appearing every 10 years or so for urban areas.

Map Name(s) and Date(s)

195NE 1951 1:10,560	196NW 1951 1:10,560
195SE 1951 1:10,560	196SW 1951 1:10,560

Historical Map - Slice B

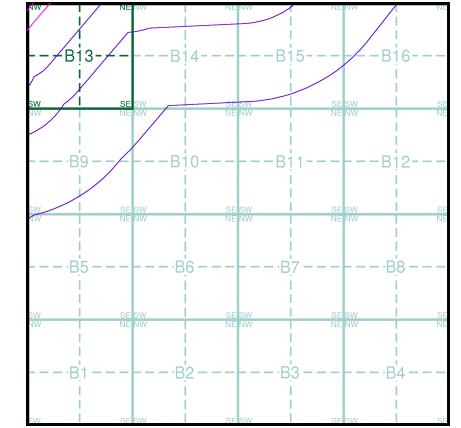

Order Details

Order Number: 201127555_1_1
 Customer Ref: PB8783-103-105
 National Grid Reference: 502940, 446720
 Slice: B
 Site Area (Ha): 62.79
 Search Buffer (m): 1000

Site Details

Hornsea Route

Landmark®
 INFORMATION GROUP

Tel: 0844 844 9952
 Fax: 0844 844 9951
 Web: www.envirocheck.co.uk

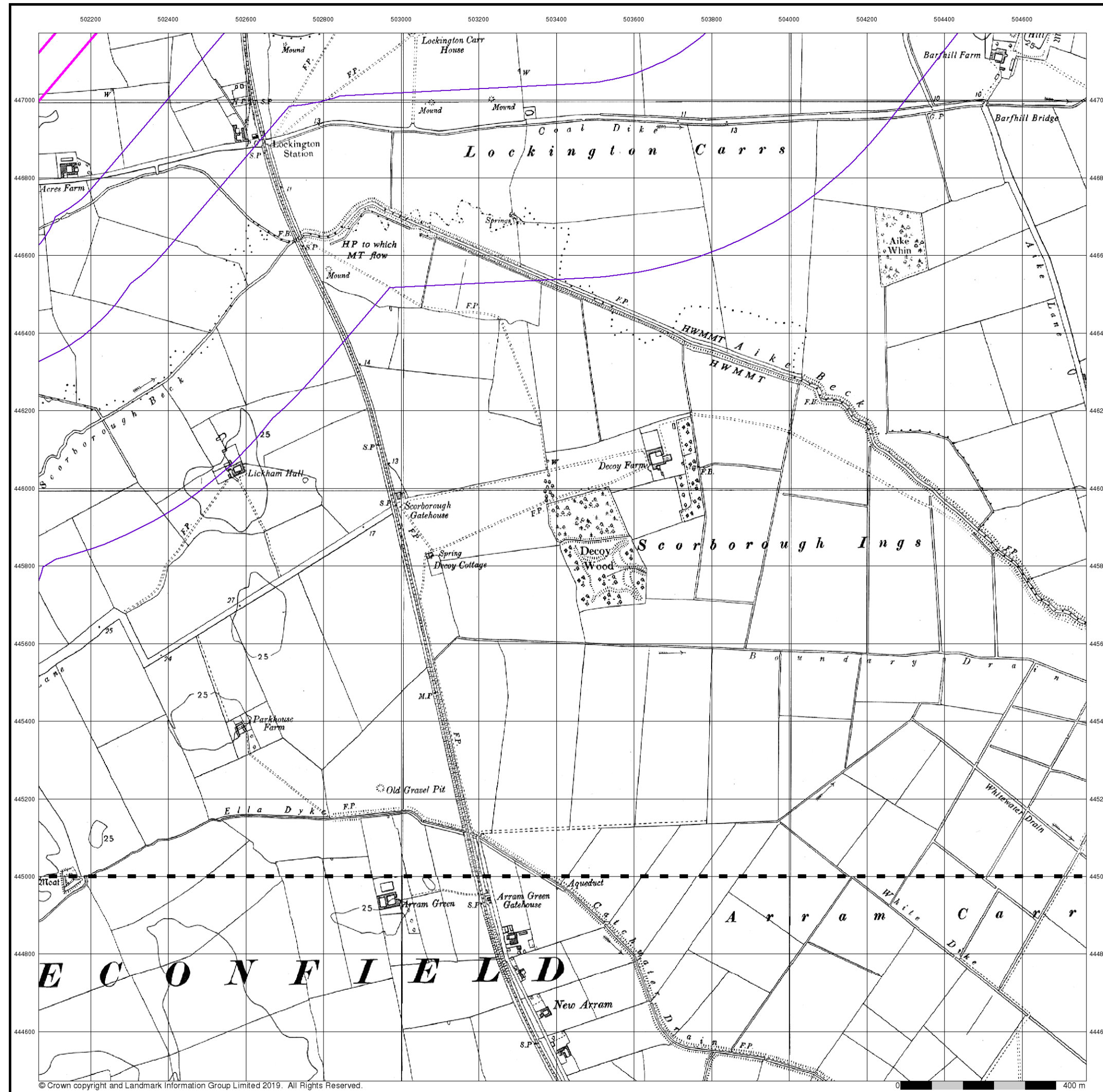

© Crown copyright and Landmark Information Group Limited 2019. All Rights Reserved.

Envirocheck®

LANDMARK INFORMATION GROUP®

Ordnance Survey Plan

Published 1956

Source map scale - 1:10,000

The historical maps shown were reproduced from maps predominantly held at the scale adopted for England, Wales and Scotland in the 1840's. In 1854 the 1:2,500 scale was adopted for mapping urban areas; these maps were used to update the 1:10,560 maps. The published date given therefore is often some years later than the surveyed date. Before 1938, all OS maps were based on the Cassini Projection, with independent surveys of a single county or group of counties, giving rise to significant inaccuracies in outlying areas. In the late 1940's, a Provisional Edition was produced, which updated the 1:10,560 mapping from a number of sources. The maps appear unfinished - with all military camps and other strategic sites removed. These maps were initially overprinted with the National Grid. In 1970, the first 1:10,000 maps were produced using the Transverse Mercator Projection. The revision process continued until recently, with new editions appearing every 10 years or so for urban areas.

Map Name(s) and Date(s)

TA04NW	1956
1:10,560	
TA04SW	1956
1:10,560	

Historical Map - Slice B

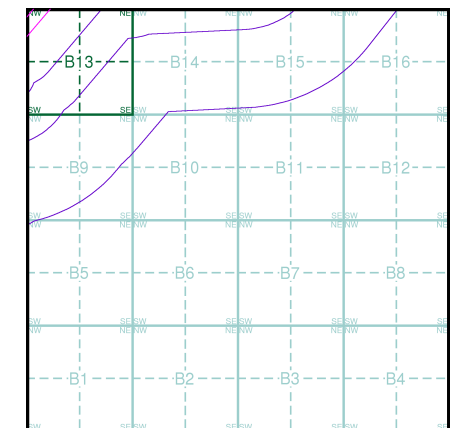

Order Details

Order Number: 201127555_1_1
 Customer Ref: PB8783-103-105
 National Grid Reference: 502940, 446720
 Slice: B
 Site Area (Ha): 62.79
 Search Buffer (m): 1000

Site Details

Hornsea Route

Landmark
 INFORMATION GROUP

Tel: 0844 844 9952
 Fax: 0844 844 9951
 Web: www.envirocheck.co.uk

Ordnance Survey Plan

Published 1975

Source map scale - 1:10,000

The historical maps shown were reproduced from maps predominantly held at the scale adopted for England, Wales and Scotland in the 1840's. In 1854 the 1:2,500 scale was adopted for mapping urban areas; these maps were used to update the 1:10,560 maps. The published date given therefore is often some years later than the surveyed date. Before 1938, all OS maps were based on the Cassini Projection, with independent surveys of a single county or group of counties, giving rise to significant inaccuracies in outlying areas. In the late 1940's, a Provisional Edition was produced, which updated the 1:10,560 mapping from a number of sources. The maps appear unfinished - with all military camps and other strategic sites removed. These maps were initially overprinted with the National Grid. In 1970, the first 1:10,000 maps were produced using the Transverse Mercator Projection. The revision process continued until recently, with new editions appearing every 10 years or so for urban areas.

Map Name(s) and Date(s)

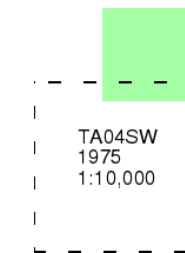

Historical Map - Slice B

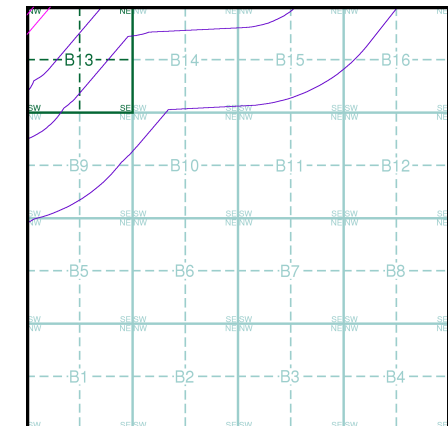

Order Details

Order Number: 201127555_1_1
 Customer Ref: PB8783-103-105
 National Grid Reference: 502940, 446720
 Slice: B
 Site Area (Ha): 62.79
 Search Buffer (m): 1000

Site Details

Hornsea Route

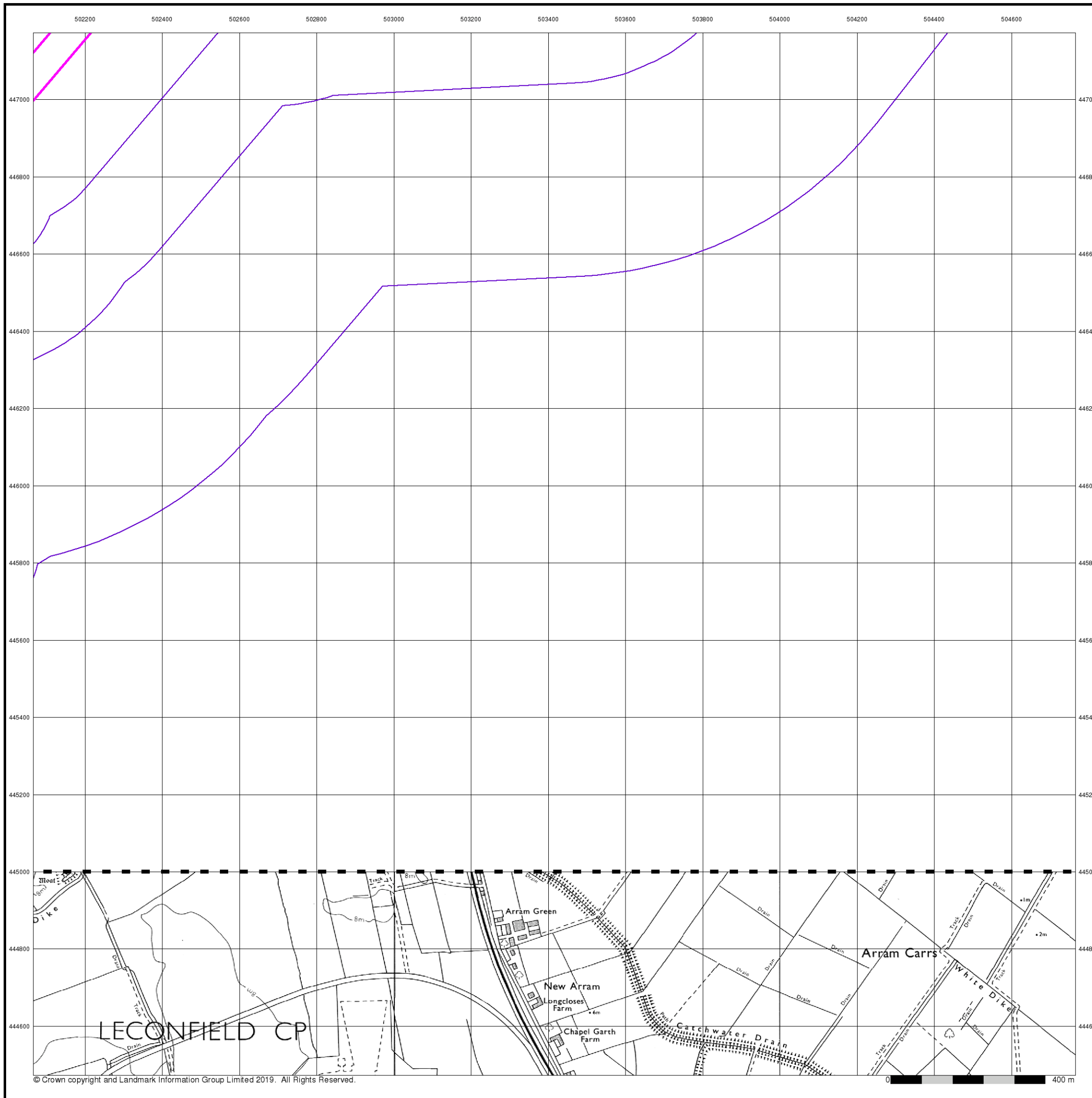

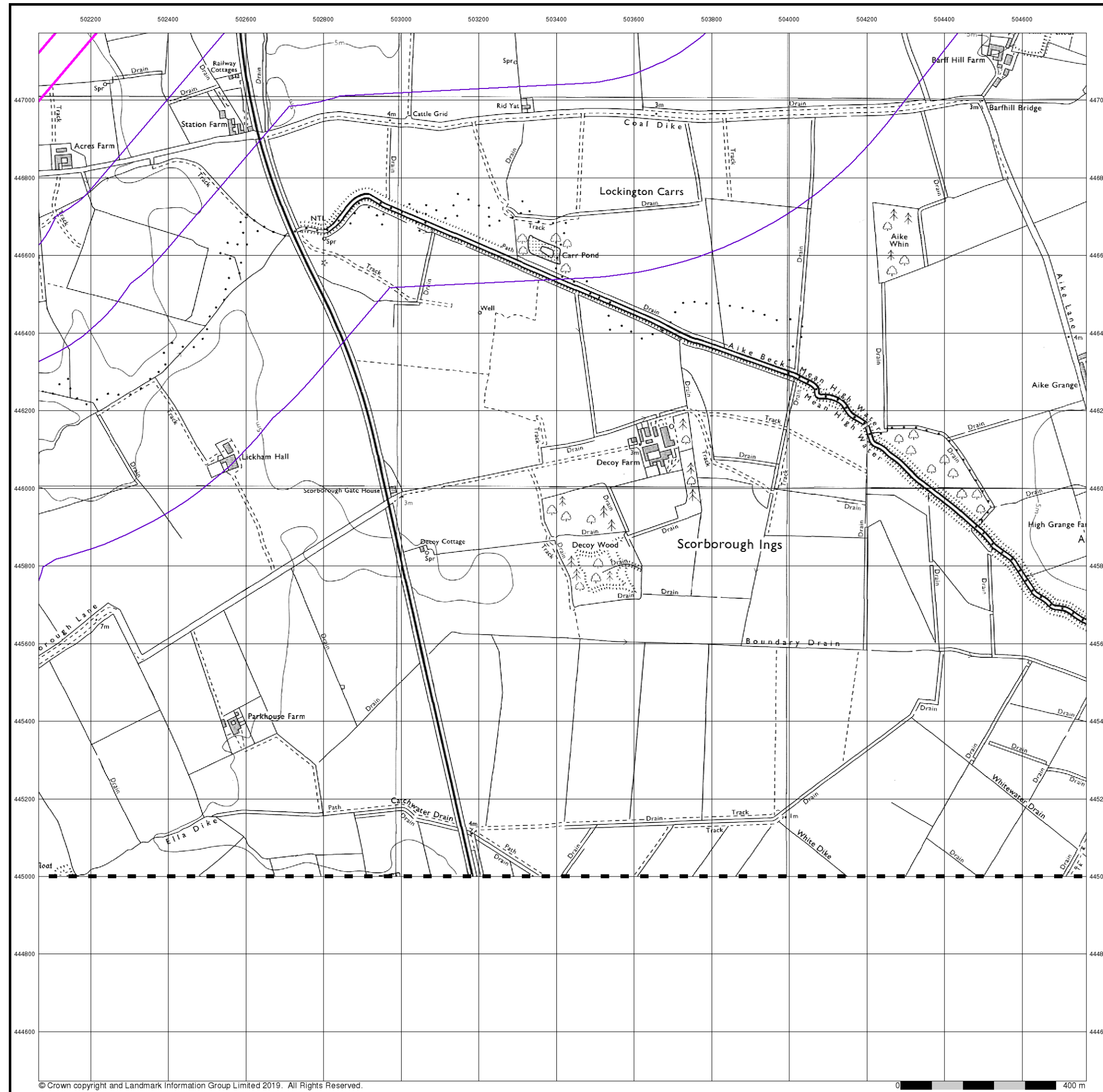

© Crown copyright and Landmark Information Group Limited 2019. All Rights Reserved.

0 400 m

Envirocheck®

LANDMARK INFORMATION GROUP®

Ordnance Survey Plan

Published 1983

Source map scale - 1:10,000

The historical maps shown were reproduced from maps predominantly held at the scale adopted for England, Wales and Scotland in the 1840's. In 1854 the 1:2,500 scale was adopted for mapping urban areas; these maps were used to update the 1:10,560 maps. The published date given therefore is often some years later than the surveyed date. Before 1938, all OS maps were based on the Cassini Projection, with independent surveys of a single county or group of counties, giving rise to significant inaccuracies in outlying areas. In the late 1940's, a Provisional Edition was produced, which updated the 1:10,560 mapping from a number of sources. The maps appear unfinished - with all military camps and other strategic sites removed. These maps were initially overprinted with the National Grid. In 1970, the first 1:10,000 maps were produced using the Transverse Mercator Projection. The revision process continued until recently, with new editions appearing every 10 years or so for urban areas.

Map Name(s) and Date(s)

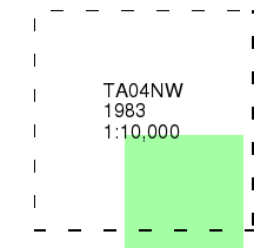

Historical Map - Slice B

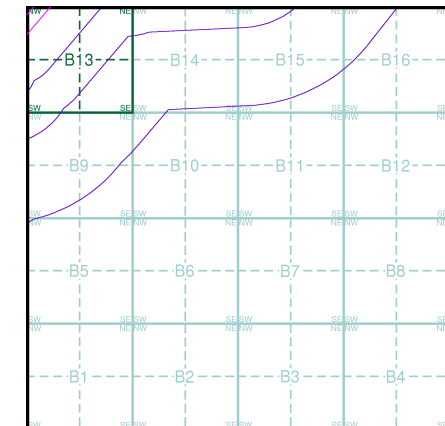

Order Details

Order Number: 201127555_1_1
 Customer Ref: PB8783-103-105
 National Grid Reference: 502940, 446720
 Slice: B
 Site Area (Ha): 62.79
 Search Buffer (m): 1000

Site Details

Hornsea Route

Landmark
 INFORMATION GROUP

Tel: 0844 844 9952
 Fax: 0844 844 9951
 Web: www.envirocheck.co.uk

Ordnance Survey Plan

Published 1994

Source map scale - 1:10,000

The historical maps shown were reproduced from maps predominantly held at the scale adopted for England, Wales and Scotland in the 1840's. In 1854 the 1:2,500 scale was adopted for mapping urban areas; these maps were used to update the 1:10,560 maps. The published date given therefore is often some years later than the surveyed date. Before 1938, all OS maps were based on the Cassini Projection, with independent surveys of a single county or group of counties, giving rise to significant inaccuracies in outlying areas. In the late 1940's, a Provisional Edition was produced, which updated the 1:10,560 mapping from a number of sources. The maps appear unfinished - with all military camps and other strategic sites removed. These maps were initially overprinted with the National Grid. In 1970, the first 1:10,000 maps were produced using the Transverse Mercator Projection. The revision process continued until recently, with new editions appearing every 10 years or so for urban areas.

Map Name(s) and Date(s)

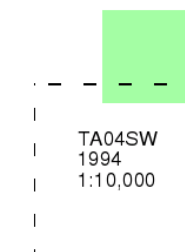

Historical Map - Slice B

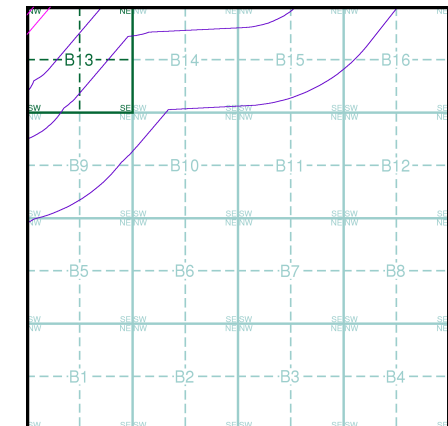

Order Details

Order Number: 201127555_1_1
 Customer Ref: PB8783-103-105
 National Grid Reference: 502940, 446720
 Slice: B
 Site Area (Ha): 62.79
 Search Buffer (m): 1000

Site Details

Hornsea Route

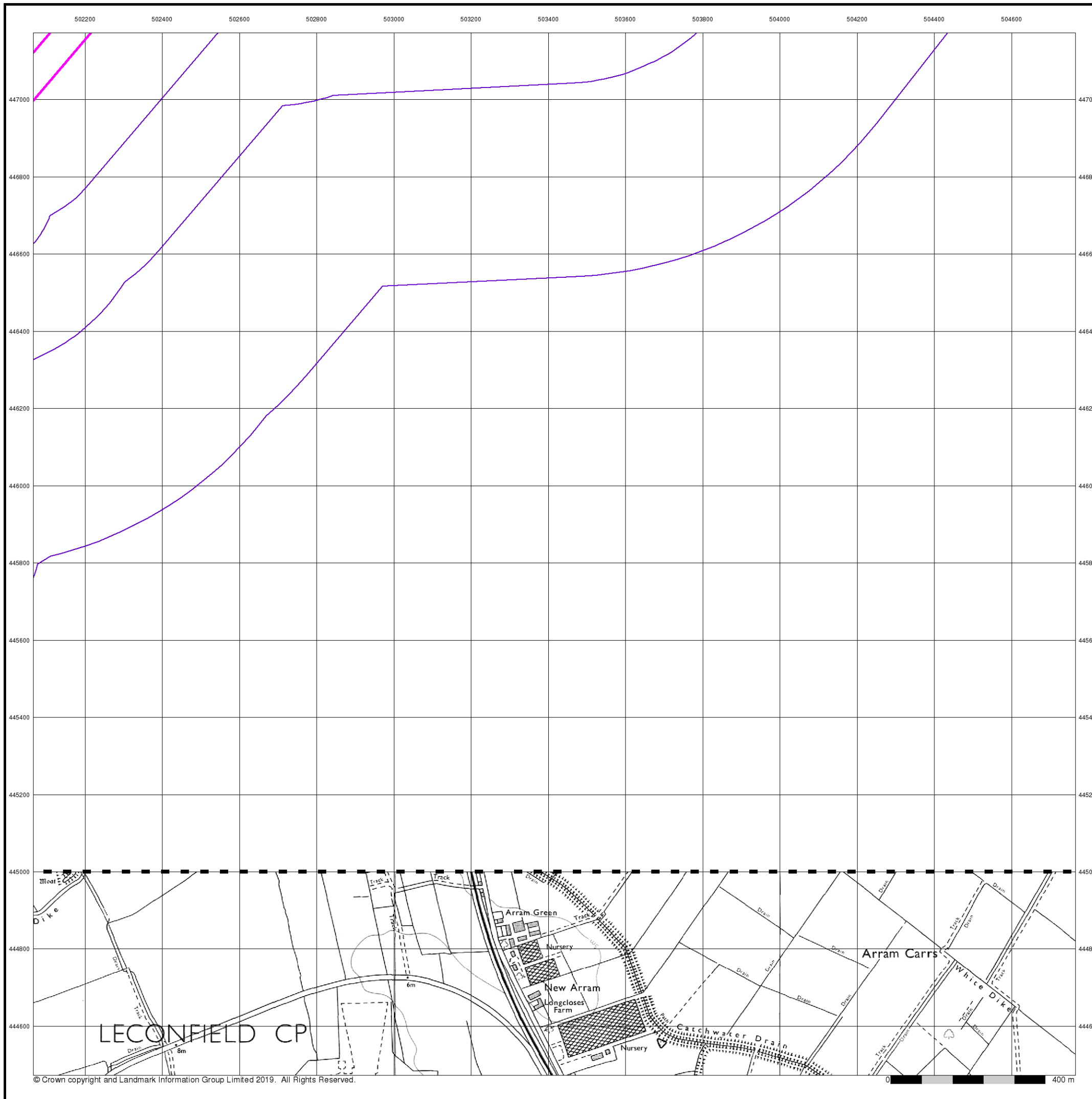

10k Raster Mapping

Published 1999

Source map scale - 1:10,000

The historical maps shown were produced from the Ordnance Survey's 1:10,000 colour raster mapping. These maps are derived from Landplan which replaced the old 1:10,000 maps originally published in 1970. The data is highly detailed showing buildings, fences and field boundaries as well as all roads, tracks and paths. Road names are also included together with the relevant road number and classification. Boundary information depiction includes county, unitary authority, district, civil parish and constituency.

Map Name(s) and Date(s)

TA04NW	1999	1:10,000
TA04SW	1999	1:10,000

Historical Map - Slice B

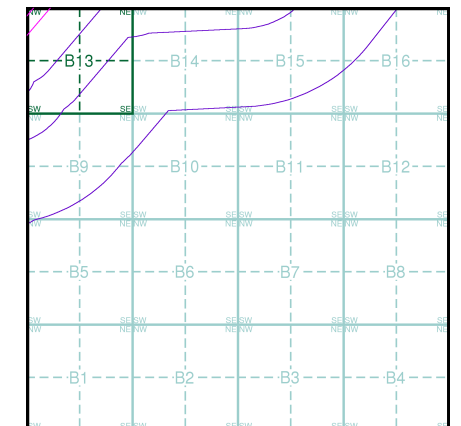

Order Details

Order Number: 201127555_1_1
 Customer Ref: PB8783-103-105
 National Grid Reference: 502940, 446720
 Slice: B
 Site Area (Ha): 62.79
 Search Buffer (m): 1000

Site Details

Hornsea Route

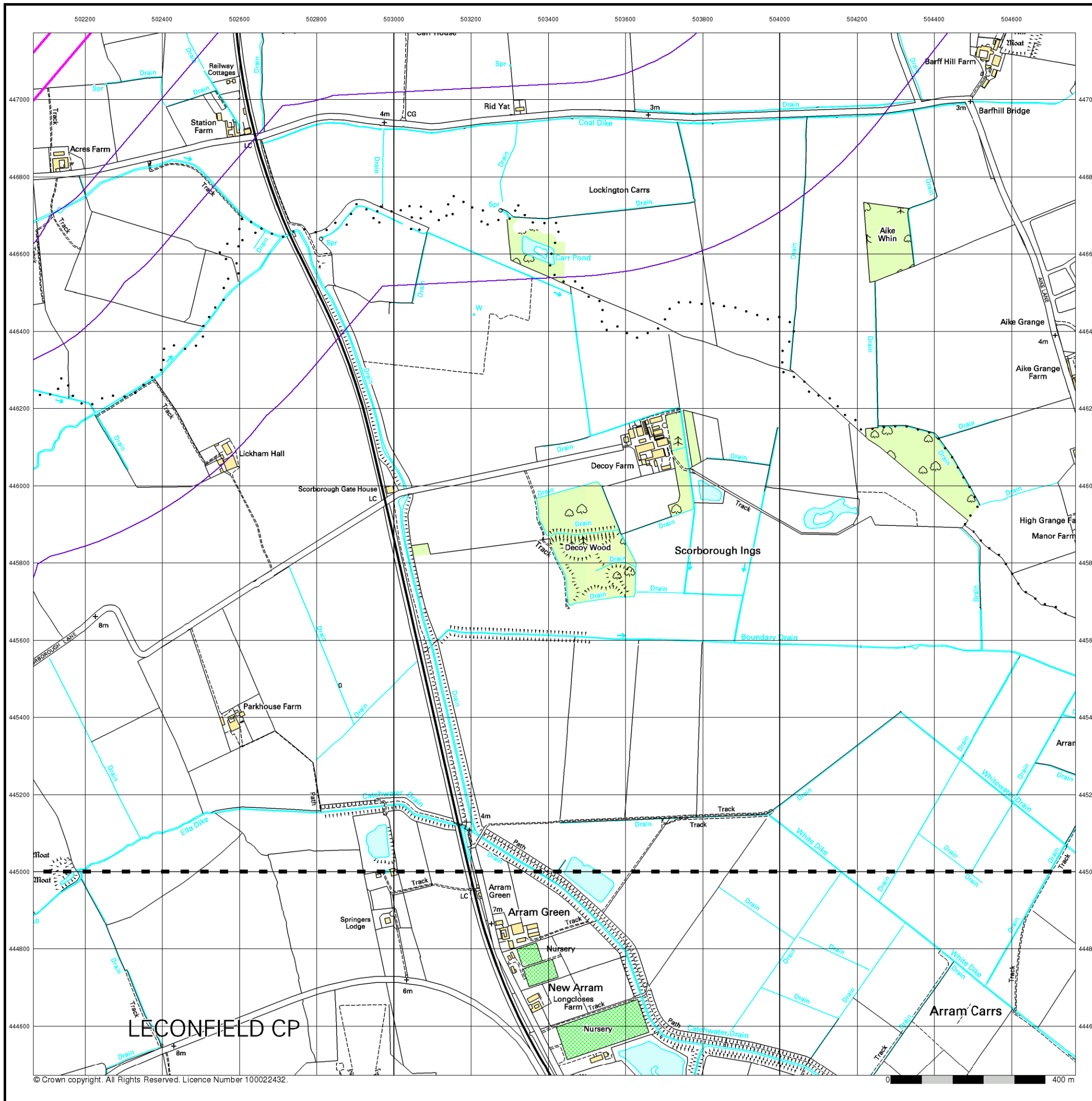

Street View

Published 2019

Source map scale - 1:10,000

Street View is a street-level map for the whole of Great Britain produced by the Ordnance Survey. These maps are provided at a nominal scale of 1:10,000

Map Name(s) and Date(s)



Street View Map - Slice B

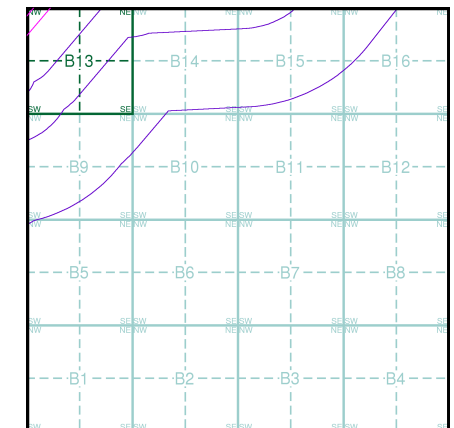

Order Details

Order Number: 201127555_1_1
 Customer Ref: PB8783-103-105
 National Grid Reference: 502940, 446720
 Slice: B
 Site Area (Ha): 62.79
 Search Buffer (m): 1000

Site Details

Hornsea Route

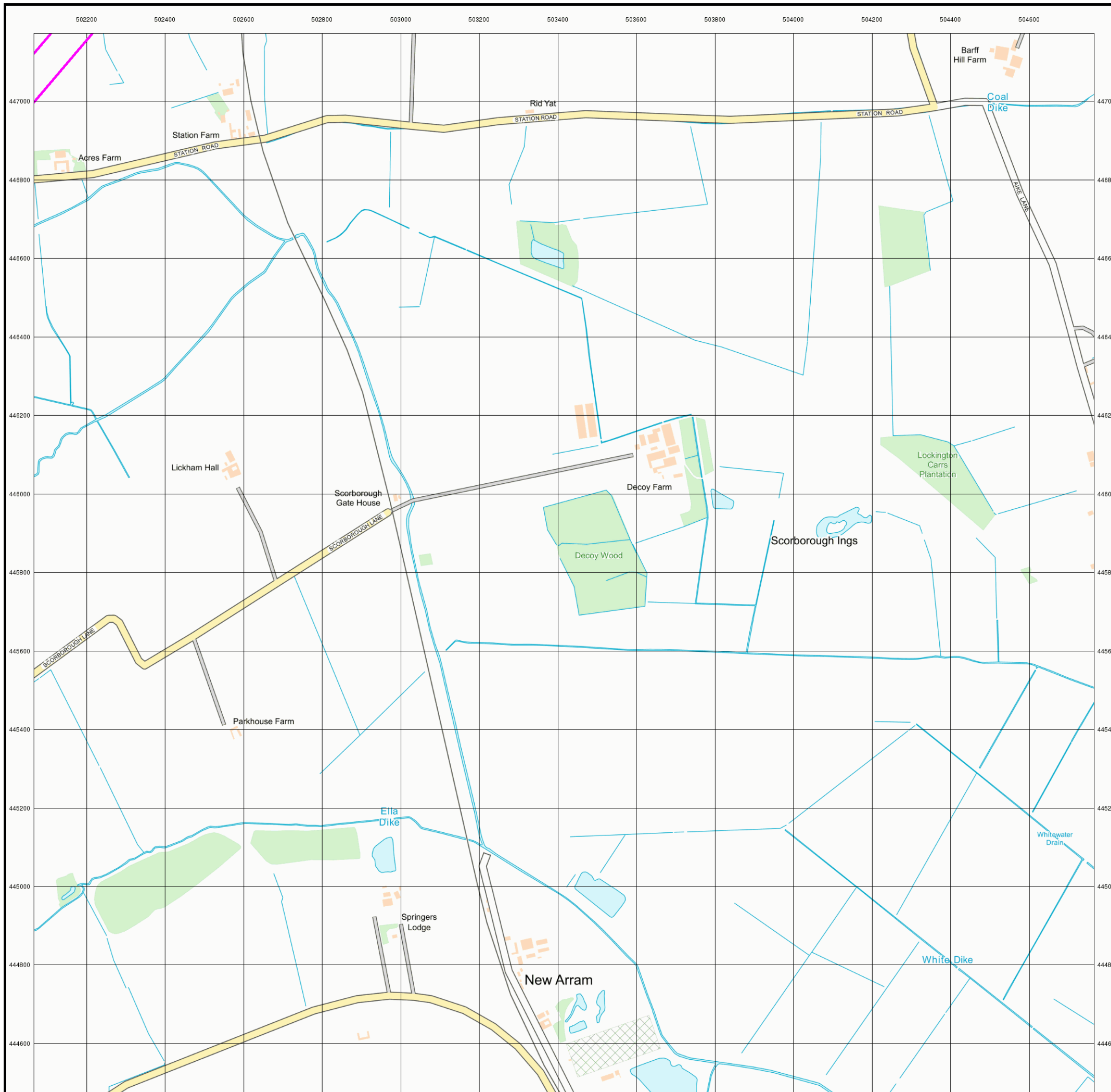

Historical Mapping Legends

Ordnance Survey County Series 1:10,560

	Gravel Pit		Sand Pit		Other Pits
	Quarry		Shingle		Orchard
	Osiers		Reeds		Marsh
	Mixed Wood		Deciduous		Brushwood
	Fir		Furze		Rough Pasture
	Arrow denotes flow of water		Trigonometrical Station		
	Site of Antiquities		Bench Mark		
	Pump, Guide Post, Signal Post		Well, Spring, Boundary Post		
	-285 Surface Level				
	Sketched Contour		Instrumental Contour		
	Main Roads		Minor Roads		
	Sunken Road		Raised Road		
	Road over Railway		Railway over River		
	Railway over Road		Level Crossing		
	Road over River or Canal		Road over Stream		
	Road over Stream				
	County Boundary (Geographical)				
	County & Civil Parish Boundary				
	Administrative County & Civil Parish Boundary				
	County Borough Boundary (England)				
	County Burgh Boundary (Scotland)				
	Rural District Boundary				
	Civil Parish Boundary				

Ordnance Survey Plan 1:10,000

	Chalk Pit, Clay Pit or Quarry		Gravel Pit
	Sand Pit		Disused Pit or Quarry
	Refuse or Slag Heap		Lake, Loch or Pond
	Dunes		Boulders
	Coniferous Trees		Non-Coniferous Trees
	Orchard		Scrub
	Coppice		Heath
	Rough Grassland		Marsh
	Reeds		Saltings
	Building		Glasshouse
	Sloping Masonry		Pylon
	Electricity Transmission Line		Pole
	Cutting		Embankment
	Standard Gauge Multiple Track		Standard Gauge Single Track
	Siding, Tramway or Mineral Line		Narrow Gauge
	Geographical County		
	Administrative County, County Borough or County of City		
	Municipal Borough, Urban or Rural District, Burgh or District Council		
	Borough, Burgh or County Constituency Shown only when not coincident with other boundaries		
	Civil Parish Shown alternately when coincidence of boundaries occurs		
	BP, BS Boundary Post or Stone		Pol Sta Police Station
	Ch Church		PO Post Office
	CH Club House		PC Public Convenience
	F E Sta Fire Engine Station		PH Public House
	FB Foot Bridge		SB Signal Box
	Fn Fountain		Spr Spring
	GP Guide Post		TCB Telephone Call Box
	MP Mile Post		TCP Telephone Call Post
	MS Mile Stone		W Well

1:10,000 Raster Mapping

	Gravel Pit		Refuse tip or slag heap
	Rock		Rock (scattered)
	Boulders		Boulders (scattered)
	Shingle		Mud
	Sand		Sand Pit
	Slopes		Top of cliff
	General detail		Underground detail
	Overhead detail		Narrow gauge railway
	Multi-track railway		Single track railway
	County boundary (England only)		Civil, parish or community boundary
	District, Unitary, Metropolitan, London Borough boundary		Constituency boundary
	Area of wooded vegetation		Non-coniferous trees
	Non-coniferous trees (scattered)		Coniferous trees
	Coniferous trees (scattered)		Positioned tree
	Orchard		Coppice or Osiers
	Rough Grassland		Heath
	Scrub		Marsh, Salt Marsh or Reeds
	Water feature		Flow arrows
	MHW(S) Mean high water (springs)		MLW(S) Mean low water (springs)
	Telephone line (where shown)		Electricity transmission line (with poles)
	Bench mark (where shown)		Triangulation station
	Point feature (e.g. Guide Post or Mile Stone)		Pylon, flare stack or lighting tower
	Site of (antiquity)		Glasshouse
	General Building		Important Building

Envirocheck®

LANDMARK INFORMATION GROUP®

Historical Mapping & Photography included:

Mapping Type	Scale	Date	Pg
Yorkshire	1:10,560	1854	2
Yorkshire	1:10,560	1892 - 1893	3
Yorkshire	1:10,560	1910 - 1911	4
Yorkshire	1:10,560	1928	5
Yorkshire	1:10,560	1938 - 1953	6
Yorkshire	1:10,560	1951	7
Ordnance Survey Plan	1:10,000	1956	8
Ordnance Survey Plan	1:10,000	1970 - 1979	9
Ordnance Survey Plan	1:10,000	1982	10
Ordnance Survey Plan	1:10,000	1993 - 1994	11
10K Raster Mapping	1:10,000	1999	12
Street View	Variable		13

Historical Map - Slice B

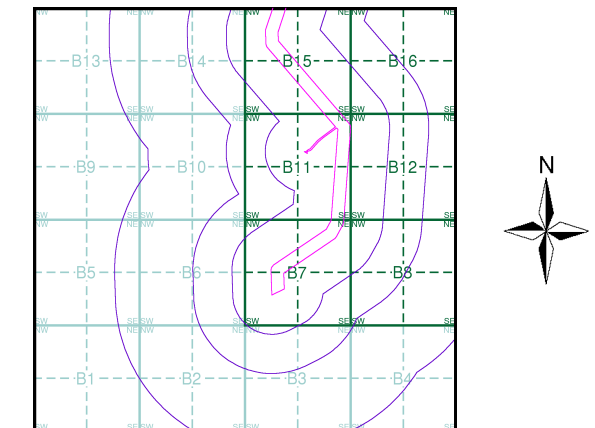

Order Details

Order Number: 201127560_1_1
 Customer Ref: PB8783-103-105
 National Grid Reference: 500310, 440950
 Slice: B
 Site Area (Ha): 53.73
 Search Buffer (m): 1000

Site Details

Hornsea Route

Landmark
 INFORMATION GROUP

Tel: 0844 844 9952
 Fax: 0844 844 9951
 Web: www.envirocheck.co.uk

The historical maps shown were reproduced from maps predominantly held at the scale adopted for England, Wales and Scotland in the 1840's. In 1854 the 1:2,500 scale was adopted for mapping urban areas; these maps were used to update the 1:10,560 maps. The published date given therefore is often some years later than the surveyed date. Before 1938, all OS maps were based on the Cassini Projection, with independent surveys of a single county or group of counties, giving rise to significant inaccuracies in outlying areas. In the late 1940's, a Provisional Edition was produced, which updated the 1:10,560 mapping from a number of sources. The maps appear unfinished - with all military camps and other strategic sites removed. These maps were initially overprinted with the National Grid. In 1970, the first 1:10,000 maps were produced using the Transverse Mercator Projection. The revision process continued until recently, with new editions appearing every 10 years or so for urban areas.

Map Name(s) and Date(s)

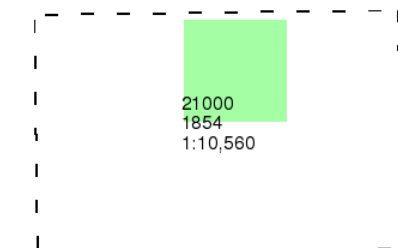

Historical Map - Slice B

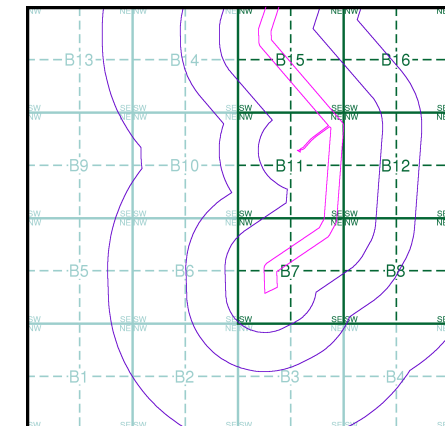

Order Details

Order Number: 201127560_1_1
 Customer Ref: PB8783-103-105
 National Grid Reference: 500310, 440950
 Slice: B
 Site Area (Ha): 53.73
 Search Buffer (m): 1000

Site Details

Horsesea Route

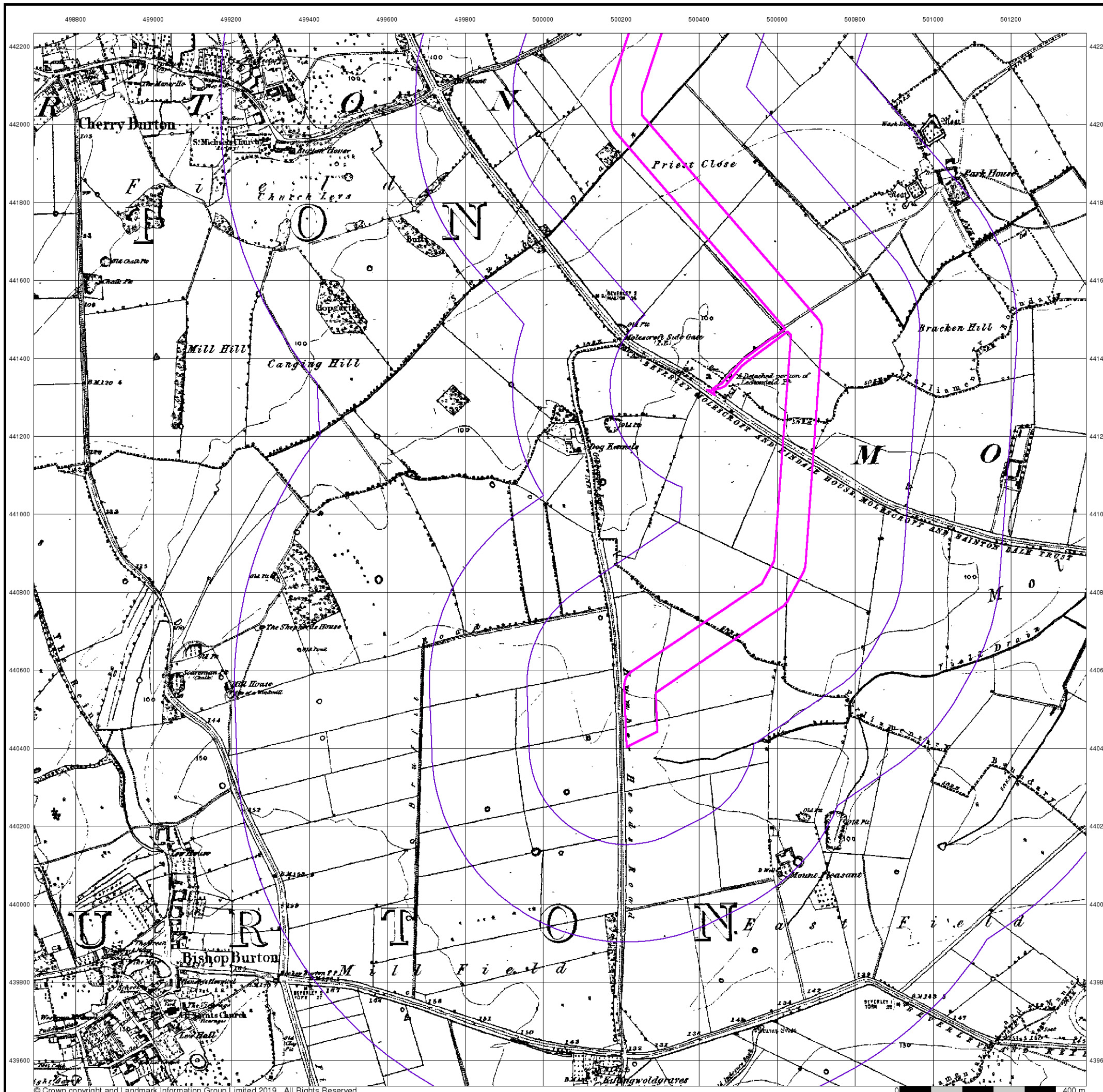

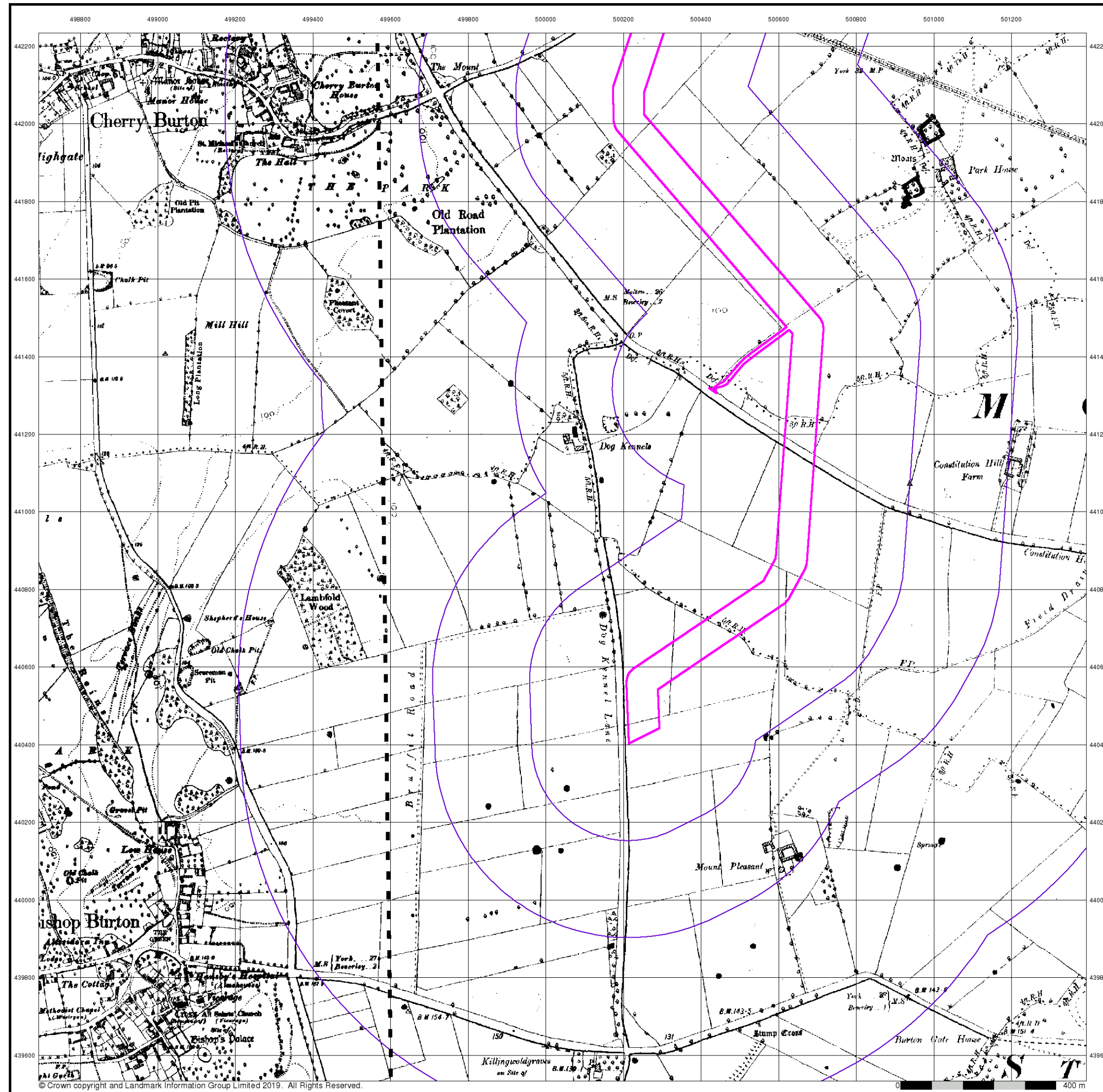

Yorkshire
Published 1892 - 1893
Source map scale - 1:10,560

The historical maps shown were reproduced from maps predominantly held at the scale adopted for England, Wales and Scotland in the 1840's. In 1854 the 1:2,500 scale was adopted for mapping urban areas; these maps were used to update the 1:10,560 maps. The published date given therefore is often some years later than the surveyed date. Before 1938, all OS maps were based on the Cassini Projection, with independent surveys of a single county or group of counties, giving rise to significant inaccuracies in outlying areas. In the late 1940's, a Provisional Edition was produced, which updated the 1:10,560 mapping from a number of sources. The maps appear unfinished - with all military camps and other strategic sites removed. These maps were initially overprinted with the National Grid. In 1970, the first 1:10,000 maps were produced using the Transverse Mercator Projection. The revision process continued until recently, with new editions appearing every 10 years or so for urban areas.

Map Name(s) and Date(s)

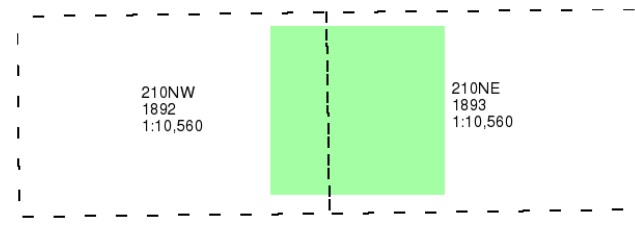

Historical Map - Slice B

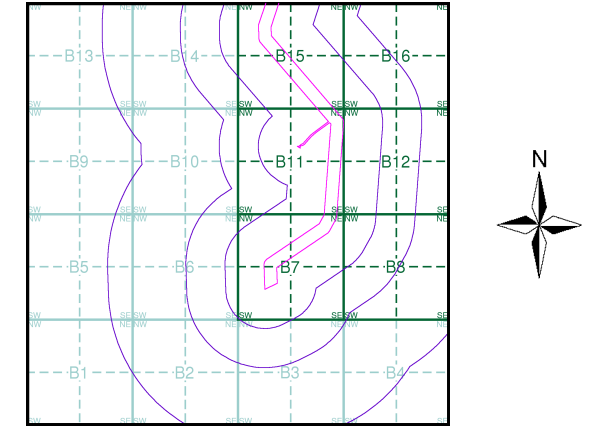

Order Details
 Order Number: 201127560_1_1
 Customer Ref: PB8783-103-105
 National Grid Reference: 500310, 440950
 Slice: B
 Site Area (Ha): 53.73
 Search Buffer (m): 1000

Site Details
 Horssea Route

The historical maps shown were reproduced from maps predominantly held at the scale adopted for England, Wales and Scotland in the 1840's. In 1854 the 1:2,500 scale was adopted for mapping urban areas; these maps were used to update the 1:10,560 maps. The published date given therefore is often some years later than the surveyed date. Before 1938, all OS maps were based on the Cassini Projection, with independent surveys of a single county or group of counties, giving rise to significant inaccuracies in outlying areas. In the late 1940's, a Provisional Edition was produced, which updated the 1:10,560 mapping from a number of sources. The maps appear unfinished - with all military camps and other strategic sites removed. These maps were initially overprinted with the National Grid. In 1970, the first 1:10,000 maps were produced using the Transverse Mercator Projection. The revision process continued until recently, with new editions appearing every 10 years or so for urban areas.

Map Name(s) and Date(s)

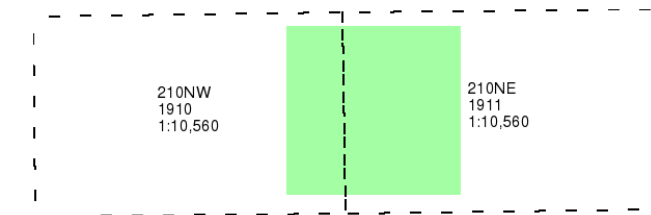

Historical Map - Slice B

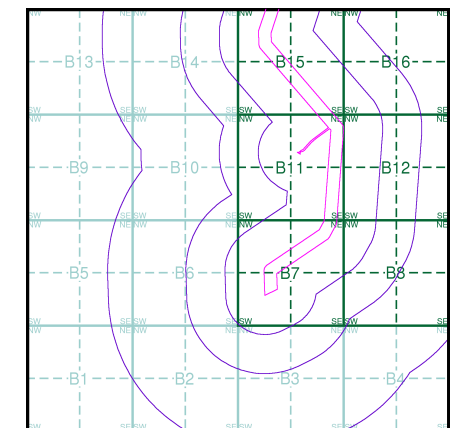

Order Details

Order Number: 201127560_1_1
 Customer Ref: PB8783-103-105
 National Grid Reference: 500310, 440950
 Slice: B
 Site Area (Ha): 53.73
 Search Buffer (m): 1000

Site Details

Hornsea Route

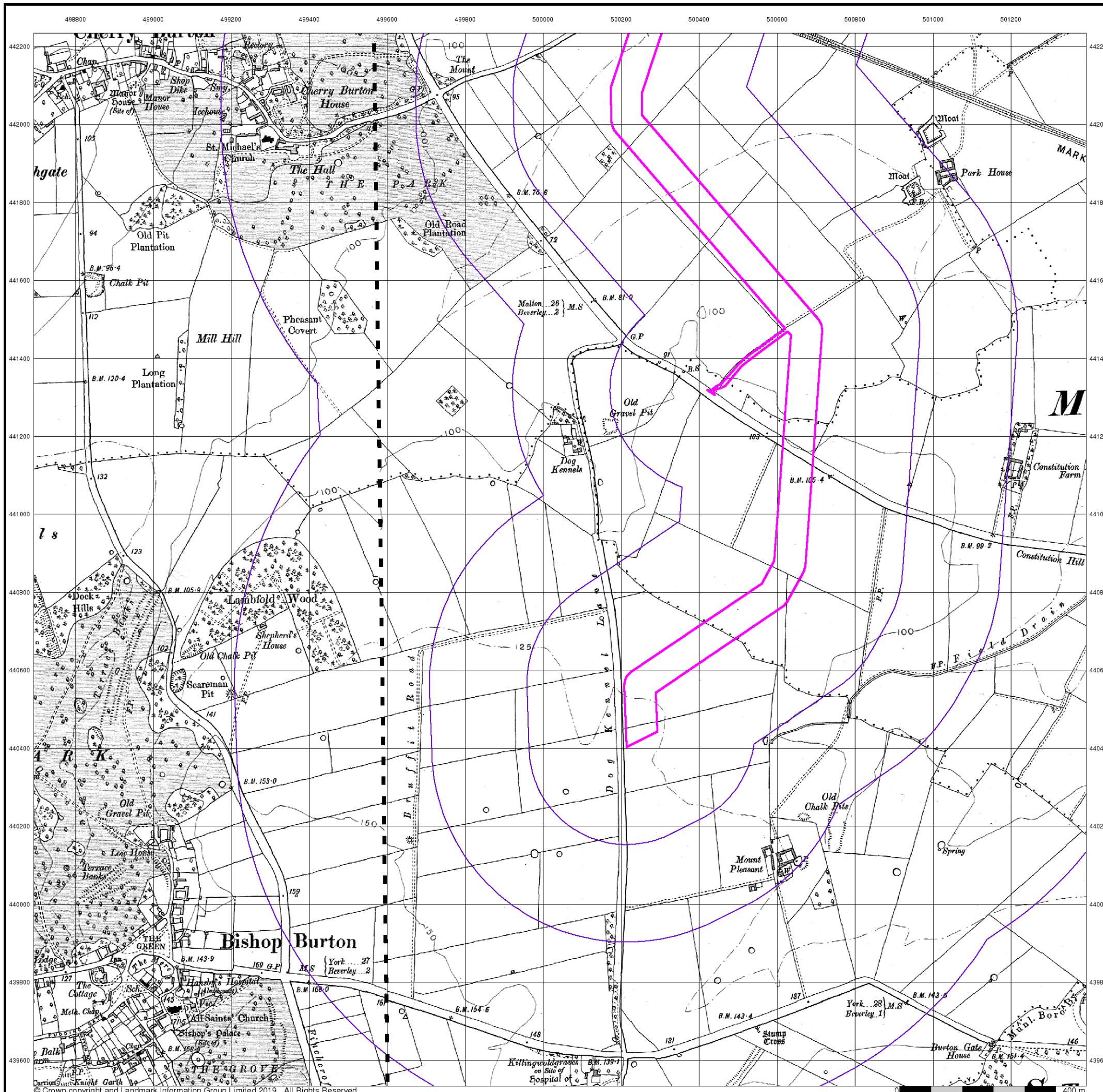

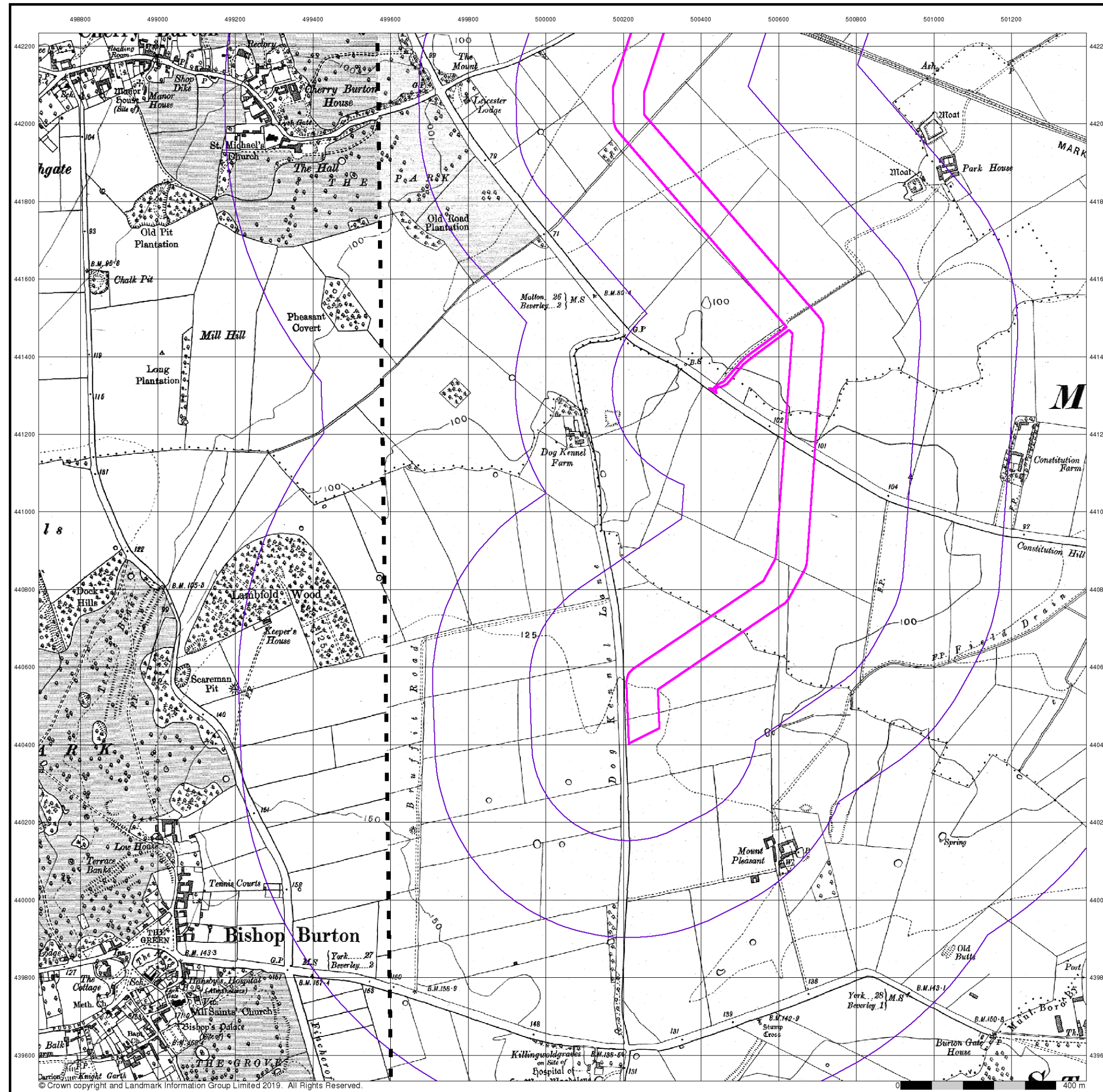

Envirocheck

LANDMARK INFORMATION GROUP

Yorkshire

Published 1928

Source map scale - 1:10,560

The historical maps shown were reproduced from maps predominantly held at the scale adopted for England, Wales and Scotland in the 1840's. In 1854 the 1:2,500 scale was adopted for mapping urban areas; these maps were used to update the 1:10,560 maps. The published date given therefore is often some years later than the surveyed date. Before 1938, all OS maps were based on the Cassini Projection, with independent surveys of a single county or group of counties, giving rise to significant inaccuracies in outlying areas. In the late 1940's, a Provisional Edition was produced, which updated the 1:10,560 mapping from a number of sources. The maps appear unfinished - with all military camps and other strategic sites removed. These maps were initially overprinted with the National Grid. In 1970, the first 1:10,000 maps were produced using the Transverse Mercator Projection. The revision process continued until recently, with new editions appearing every 10 years or so for urban areas.

Map Name(s) and Date(s)

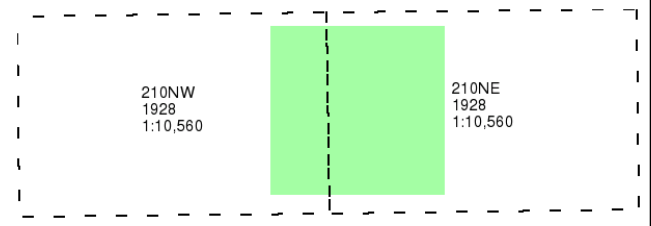

Historical Map - Slice B

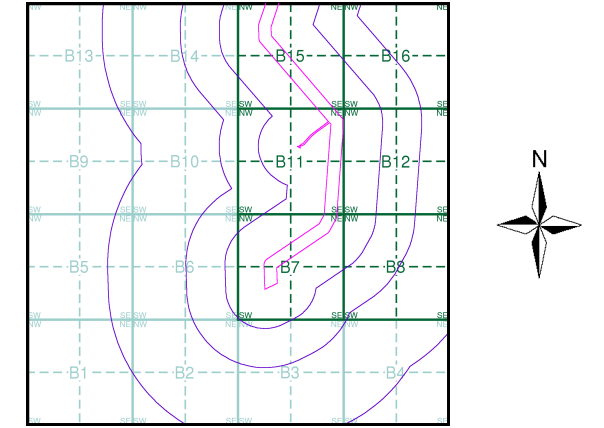

Order Details

Order Number: 201127560_1_1
 Customer Ref: PB8783-103-105
 National Grid Reference: 500310, 440950
 Slice: B
 Site Area (Ha): 53.73
 Search Buffer (m): 1000

Site Details

Horsea Route

Landmark
 INFORMATION GROUP

Tel: 0844 844 9952
 Fax: 0844 844 9951
 Web: www.envirocheck.co.uk

The historical maps shown were reproduced from maps predominantly held at the scale adopted for England, Wales and Scotland in the 1840's. In 1854 the 1:2,500 scale was adopted for mapping urban areas; these maps were used to update the 1:10,560 maps. The published date given therefore is often some years later than the surveyed date. Before 1938, all OS maps were based on the Cassini Projection, with independent surveys of a single county or group of counties, giving rise to significant inaccuracies in outlying areas. In the late 1940's, a Provisional Edition was produced, which updated the 1:10,560 mapping from a number of sources. The maps appear unfinished - with all military camps and other strategic sites removed. These maps were initially overprinted with the National Grid. In 1970, the first 1:10,000 maps were produced using the Transverse Mercator Projection. The revision process continued until recently, with new editions appearing every 10 years or so for urban areas.

Map Name(s) and Date(s)

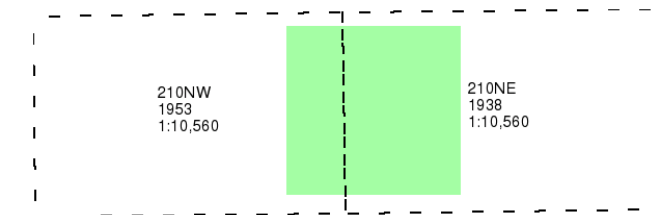

Historical Map - Slice B

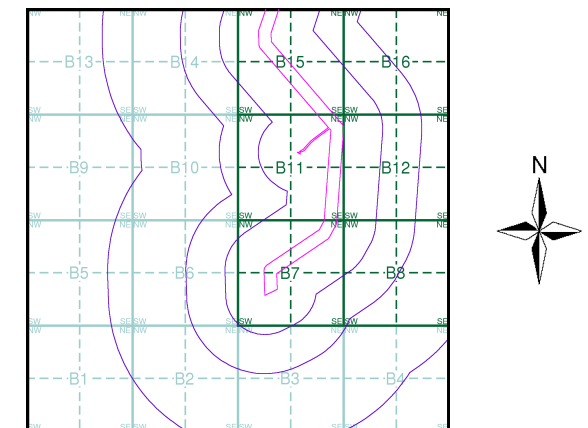

Order Details

Order Number: 201127560_1_1
 Customer Ref: PB8783-103-105
 National Grid Reference: 500310, 440950
 Slice: B
 Site Area (Ha): 53.73
 Search Buffer (m): 1000

Site Details

Hornsea Route

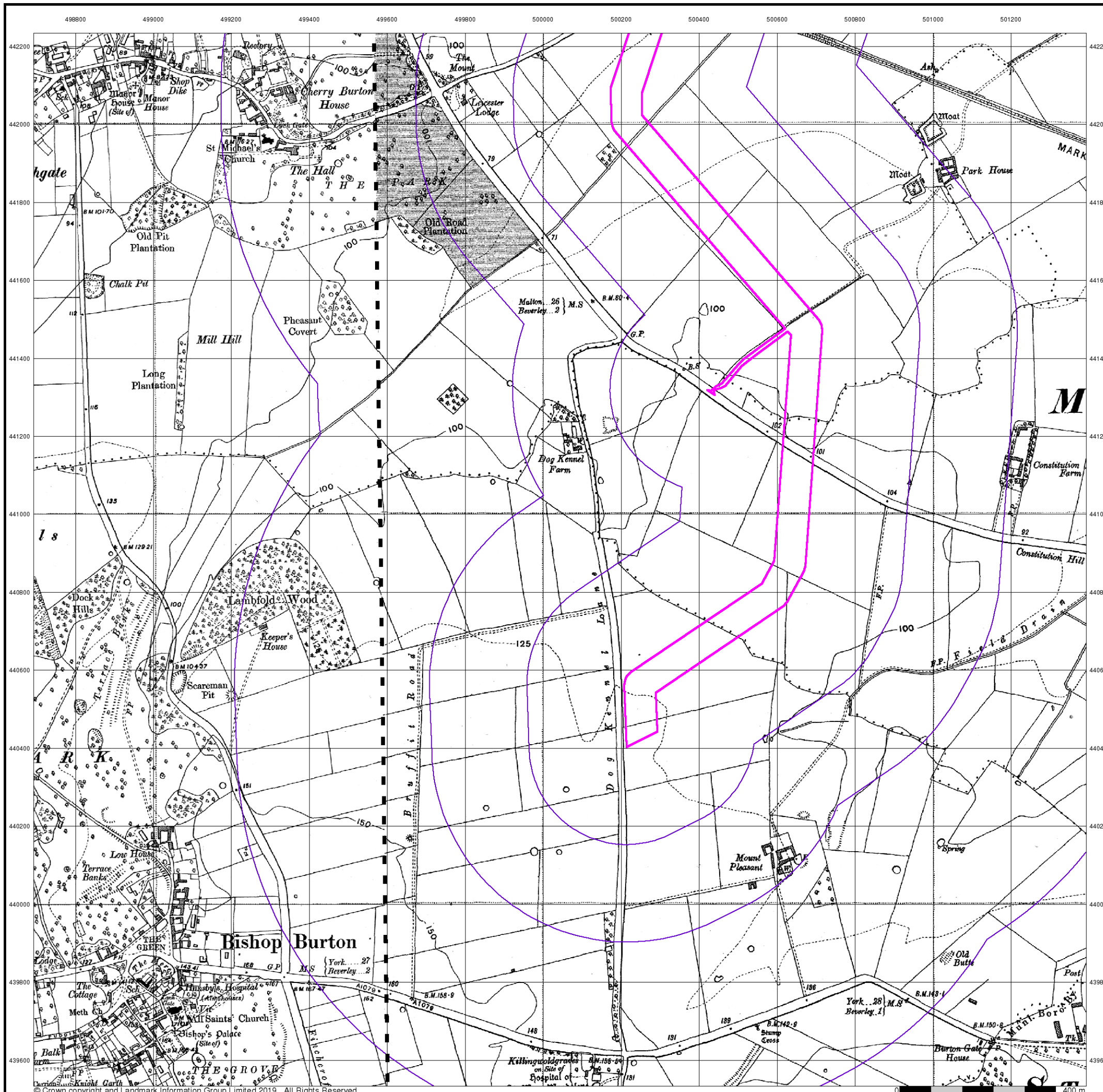

The historical maps shown were reproduced from maps predominantly held at the scale adopted for England, Wales and Scotland in the 1840's. In 1854 the 1:2,500 scale was adopted for mapping urban areas; these maps were used to update the 1:10,560 maps. The published date given therefore is often some years later than the surveyed date. Before 1938, all OS maps were based on the Cassini Projection, with independent surveys of a single county or group of counties, giving rise to significant inaccuracies in outlying areas. In the late 1940's, a Provisional Edition was produced, which updated the 1:10,560 mapping from a number of sources. The maps appear unfinished - with all military camps and other strategic sites removed. These maps were initially overprinted with the National Grid. In 1970, the first 1:10,000 maps were produced using the Transverse Mercator Projection. The revision process continued until recently, with new editions appearing every 10 years or so for urban areas.

Map Name(s) and Date(s)

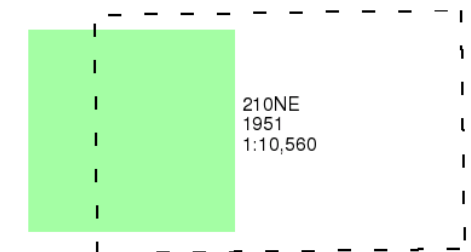

Historical Map - Slice B

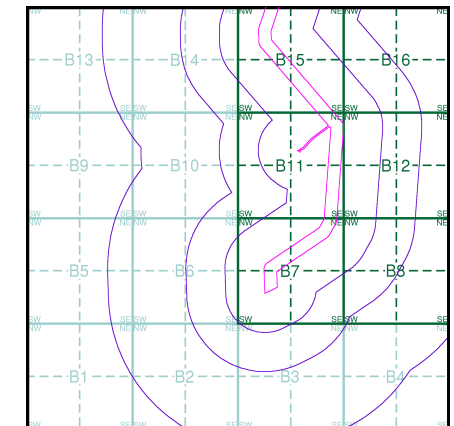

Order Details

Order Number: 201127560_1_1
Customer Ref: PB8783-103-105
National Grid Reference: 500310, 440950
Slice: B
Site Area (Ha): 53.73
Search Buffer (m): 1000

Site Details

Hornsea Route

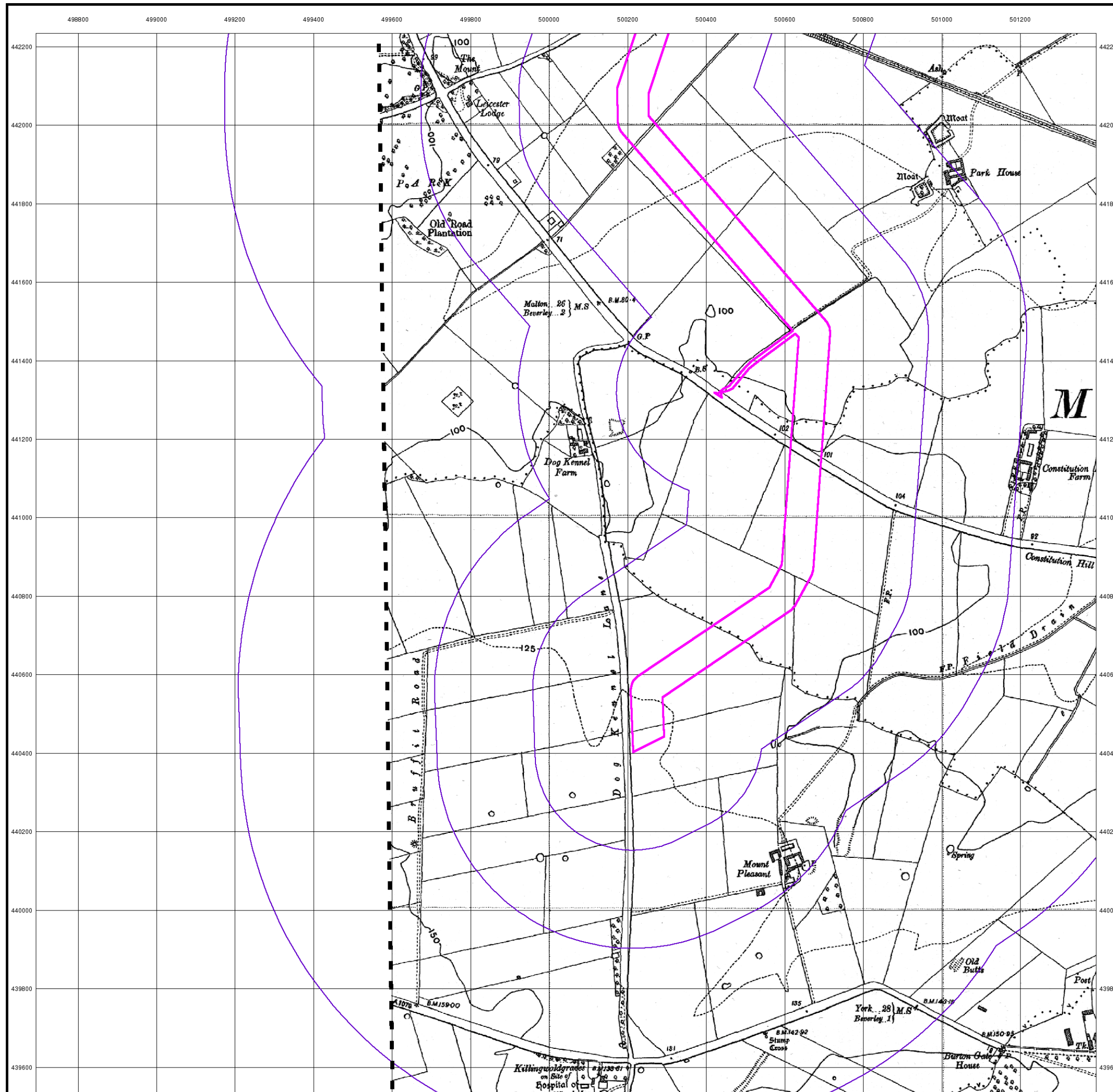

Ordnance Survey Plan

Published 1956

Source map scale - 1:10,000

The historical maps shown were reproduced from maps predominantly held at the scale adopted for England, Wales and Scotland in the 1840's. In 1854 the 1:2,500 scale was adopted for mapping urban areas; these maps were used to update the 1:10,560 maps. The published date given therefore is often some years later than the surveyed date. Before 1938, all OS maps were based on the Cassini Projection, with independent surveys of a single county or group of counties, giving rise to significant inaccuracies in outlying areas. In the late 1940's, a Provisional Edition was produced, which updated the 1:10,560 mapping from a number of sources. The maps appear unfinished - with all military camps and other strategic sites removed. These maps were initially overprinted with the National Grid. In 1970, the first 1:10,000 maps were produced using the Transverse Mercator Projection. The revision process continued until recently, with new editions appearing every 10 years or so for urban areas.

Map Name(s) and Date(s)

SE94SE	TA04SW
1956	1956
1:10,560	1:10,560
SE93NE	TA03NW
1956	1956
1:10,560	1:10,560

Historical Map - Slice B

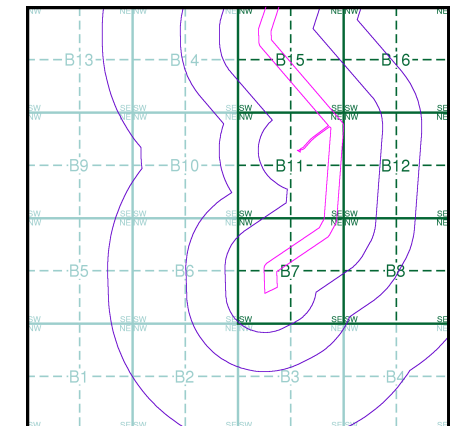

Order Details

Order Number: 201127560_1_1
 Customer Ref: PB8783-103-105
 National Grid Reference: 500310, 440950
 Slice: B
 Site Area (Ha): 53.73
 Search Buffer (m): 1000

Site Details

Horsea Route

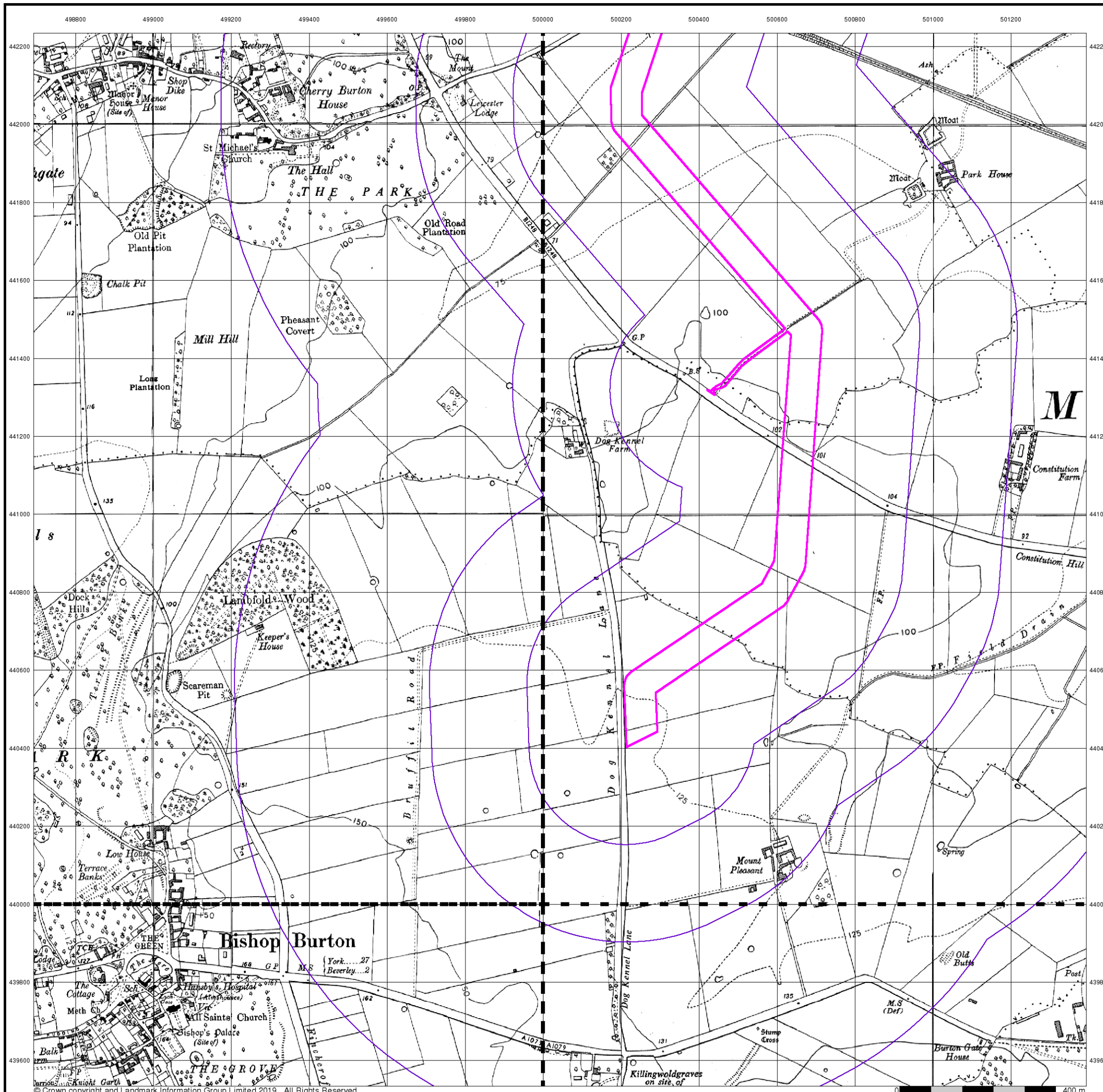

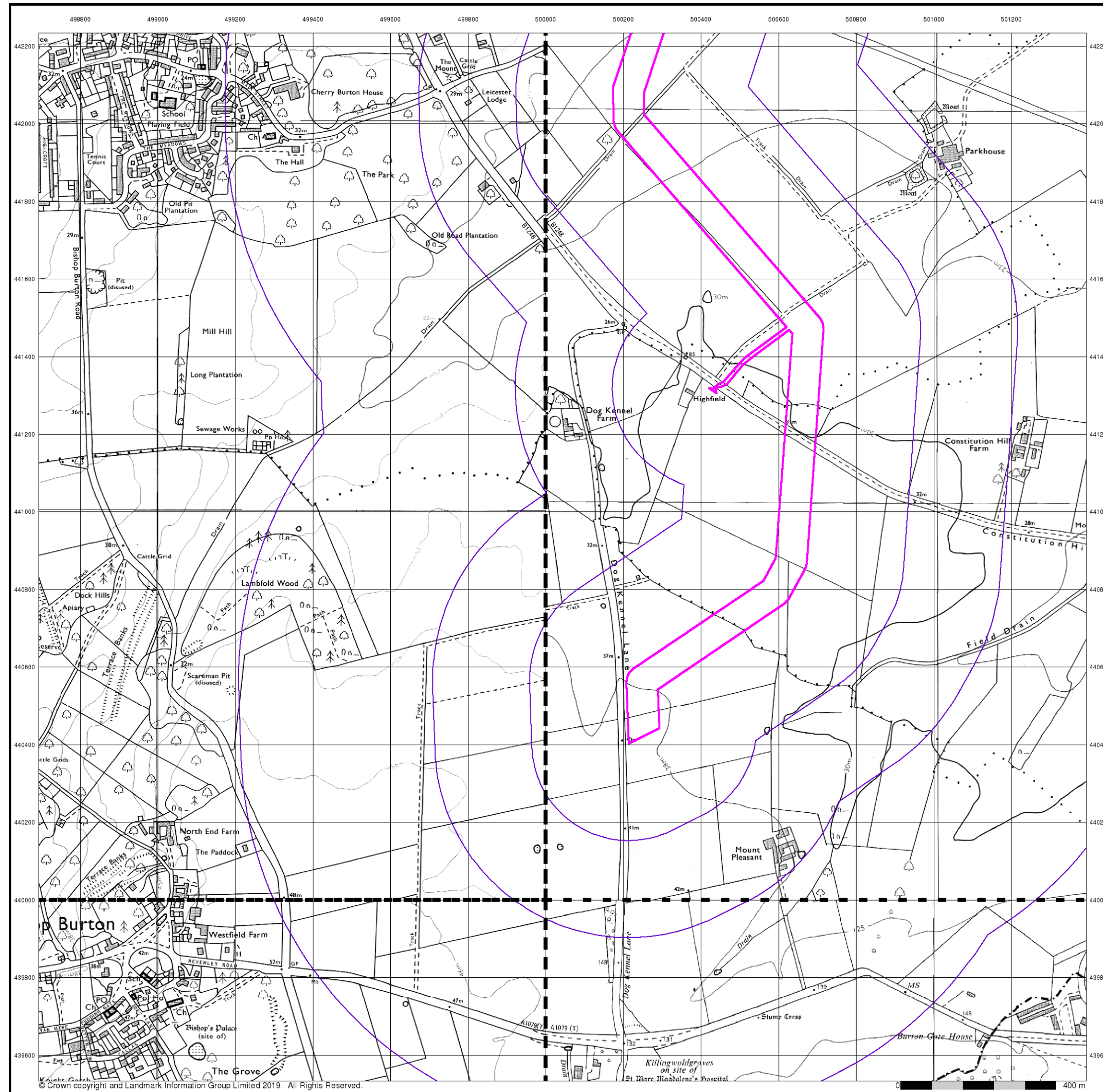

Ordnance Survey Plan

Published 1970 - 1979

Source map scale - 1:10,000

The historical maps shown were reproduced from maps predominantly held at the scale adopted for England, Wales and Scotland in the 1840's. In 1854 the 1:2,500 scale was adopted for mapping urban areas; these maps were used to update the 1:10,560 maps. The published date given therefore is often some years later than the surveyed date. Before 1938, all OS maps were based on the Cassini Projection, with independent surveys of a single county or group of counties, giving rise to significant inaccuracies in outlying areas. In the late 1940's, a Provisional Edition was produced, which updated the 1:10,560 mapping from a number of sources. The maps appear unfinished - with all military camps and other strategic sites removed. These maps were initially overprinted with the National Grid. In 1970, the first 1:10,000 maps were produced using the Transverse Mercator Projection. The revision process continued until recently, with new editions appearing every 10 years or so for urban areas.

Map Name(s) and Date(s)

SE94SE	TA04SW
1979	1975
1:10,000	1:10,000
SE93NE	TA03NW
1974	1970
1:10,000	1:10,560

Historical Map - Slice B

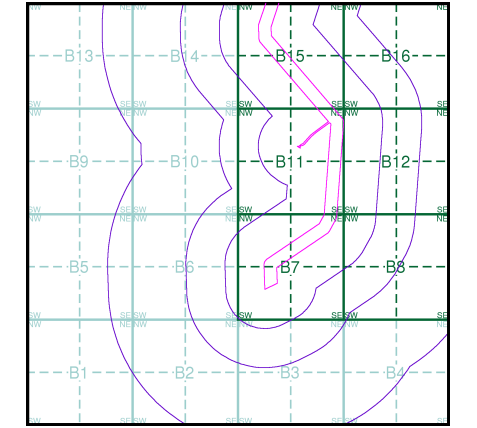

Order Details

Order Number: 201127560_1_1
 Customer Ref: PB8783-103-105
 National Grid Reference: 500310, 440950
 Slice: B
 Site Area (Ha): 53.73
 Search Buffer (m): 1000

Site Details

Horsea Route

Ordnance Survey Plan

Published 1982

Source map scale - 1:10,000

The historical maps shown were reproduced from maps predominantly held at the scale adopted for England, Wales and Scotland in the 1840's. In 1854 the 1:2,500 scale was adopted for mapping urban areas; these maps were used to update the 1:10,560 maps. The published date given therefore is often some years later than the surveyed date. Before 1938, all OS maps were based on the Cassini Projection, with independent surveys of a single county or group of counties, giving rise to significant inaccuracies in outlying areas. In the late 1940's, a Provisional Edition was produced, which updated the 1:10,560 mapping from a number of sources. The maps appear unfinished - with all military camps and other strategic sites removed. These maps were initially overprinted with the National Grid. In 1970, the first 1:10,000 maps were produced using the Transverse Mercator Projection. The revision process continued until recently, with new editions appearing every 10 years or so for urban areas.

Map Name(s) and Date(s)

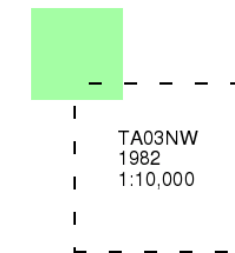

Historical Map - Slice B

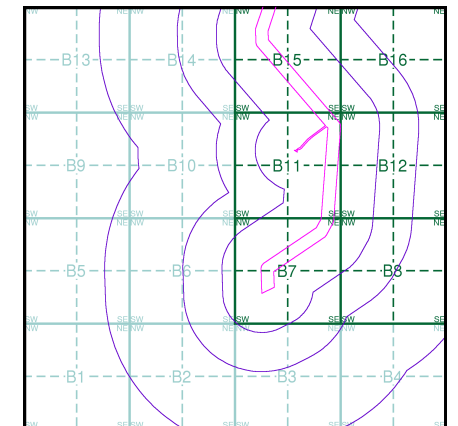

Order Details

Order Number: 201127560_1_1
Customer Ref: PB8783-103-105
National Grid Reference: 500310, 440950
Slice: B
Site Area (Ha): 53.73
Search Buffer (m): 1000

Site Details

Hornsea Route

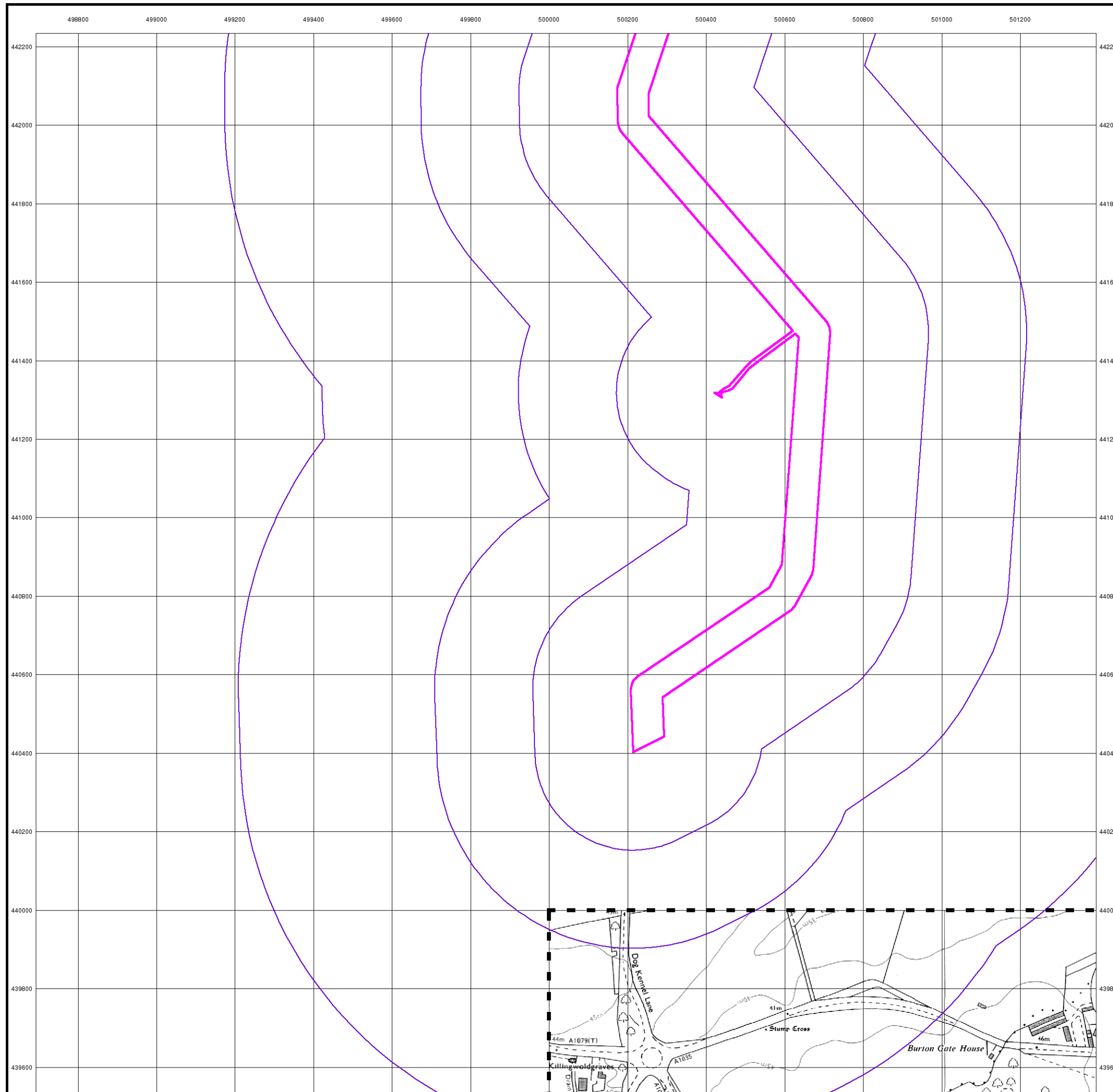

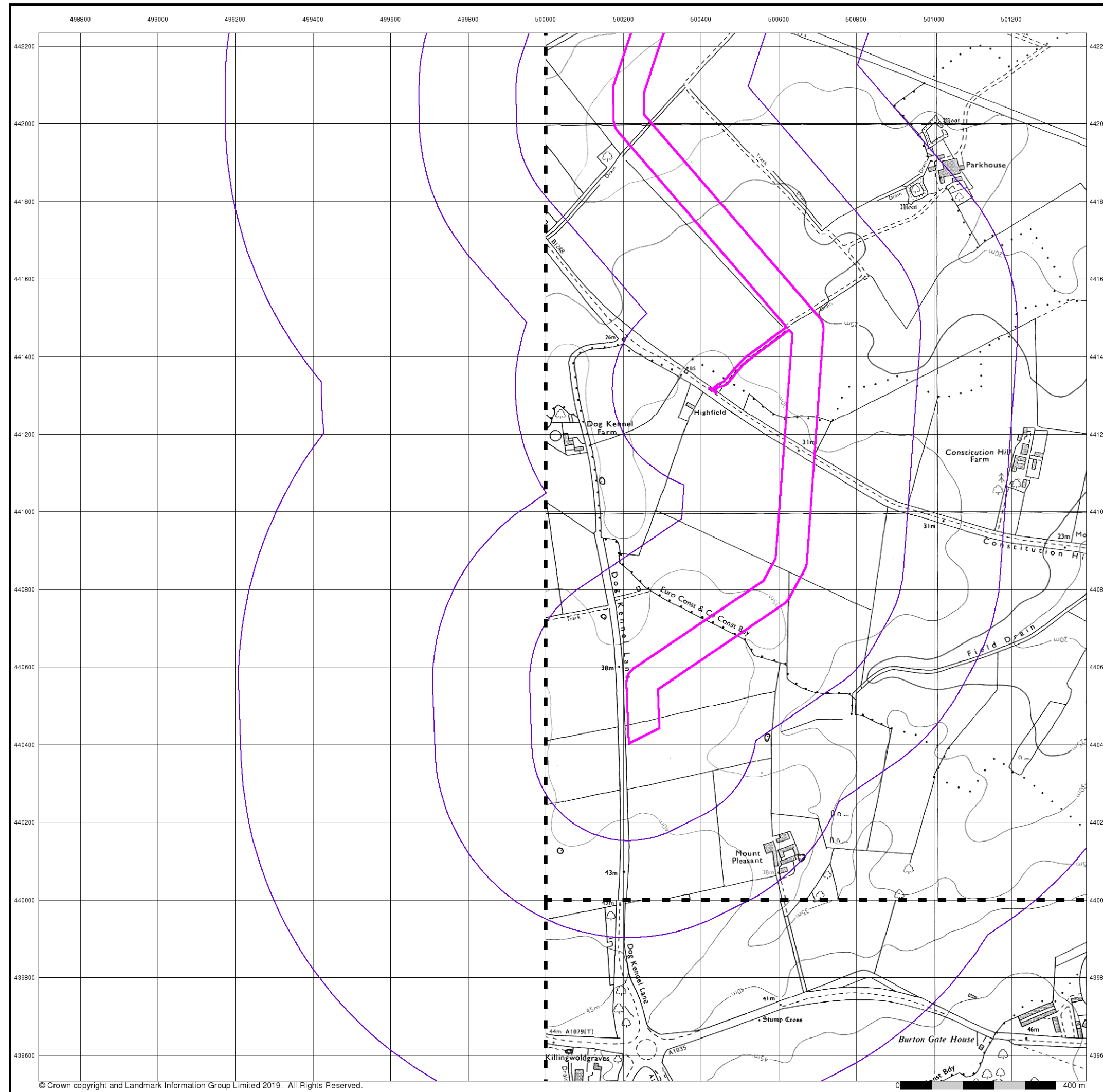

Ordnance Survey Plan

Published 1993 - 1994

Source map scale - 1:10,000

The historical maps shown were reproduced from maps predominantly held at the scale adopted for England, Wales and Scotland in the 1840's. In 1854 the 1:2,500 scale was adopted for mapping urban areas; these maps were used to update the 1:10,560 maps. The published date given therefore is often some years later than the surveyed date. Before 1938, all OS maps were based on the Cassini Projection, with independent surveys of a single county or group of counties, giving rise to significant inaccuracies in outlying areas. In the late 1940's, a Provisional Edition was produced, which updated the 1:10,560 mapping from a number of sources. The maps appear unfinished - with all military camps and other strategic sites removed. These maps were initially overprinted with the National Grid. In 1970, the first 1:10,000 maps were produced using the Transverse Mercator Projection. The revision process continued until recently, with new editions appearing every 10 years or so for urban areas.

Map Name(s) and Date(s)

TA04SW	1994	1:10,000
TA03NW	1993	1:10,000

Historical Map - Slice B

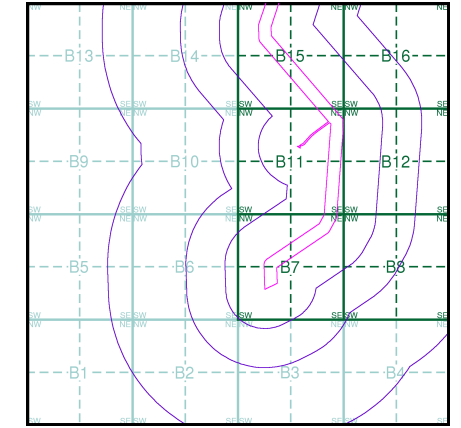

Order Details

Order Number: 201127560_1_1
 Customer Ref: PB8783-103-105
 National Grid Reference: 500310, 440950
 Slice: B
 Site Area (Ha): 53.73
 Search Buffer (m): 1000

Site Details

Horsea Route

10k Raster Mapping

Published 1999

Source map scale - 1:10,000

The historical maps shown were produced from the Ordnance Survey's 1:10,000 colour raster mapping. These maps are derived from Landplan which replaced the old 1:10,000 maps originally published in 1970. The data is highly detailed showing buildings, fences and field boundaries as well as all roads, tracks and paths. Road names are also included together with the relevant road number and classification. Boundary information depiction includes county, unitary authority, district, civil parish and constituency.

Map Name(s) and Date(s)

SE94SE	TA04SW
1999	1999
1:10,000	1:10,000
SE93NE	TA03NW
1999	1999
1:10,000	1:10,000

Historical Map - Slice B

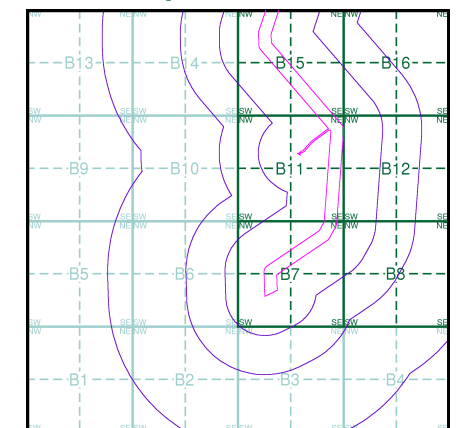

Order Details

Order Number: 201127560_1_1
 Customer Ref: PB8783-103-105
 National Grid Reference: 500310, 440950
 Slice: B
 Site Area (Ha): 53.73
 Search Buffer (m): 1000

Site Details

Hornsea Route

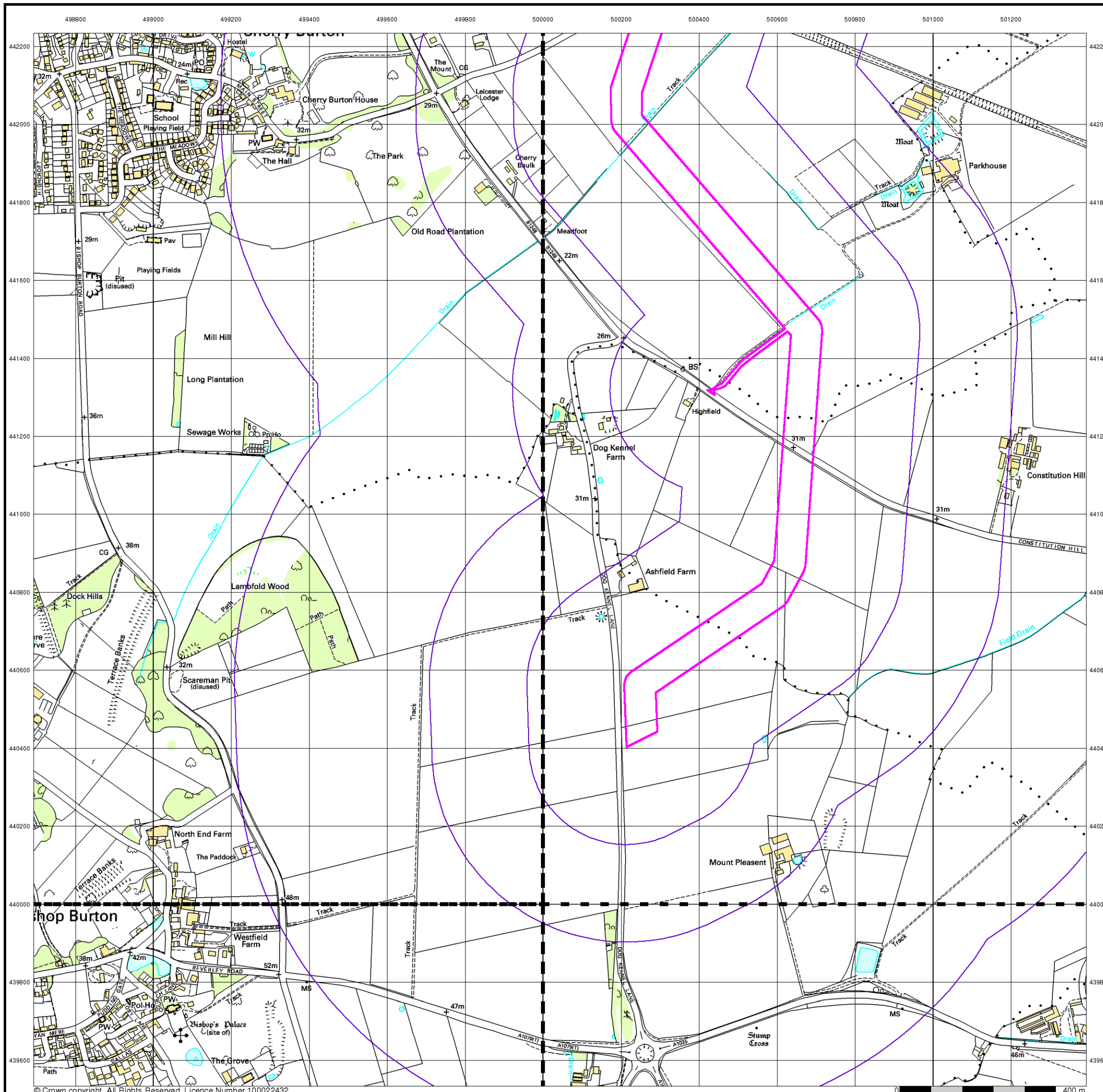

© Crown copyright. All Rights Reserved. Licence Number 100022432.

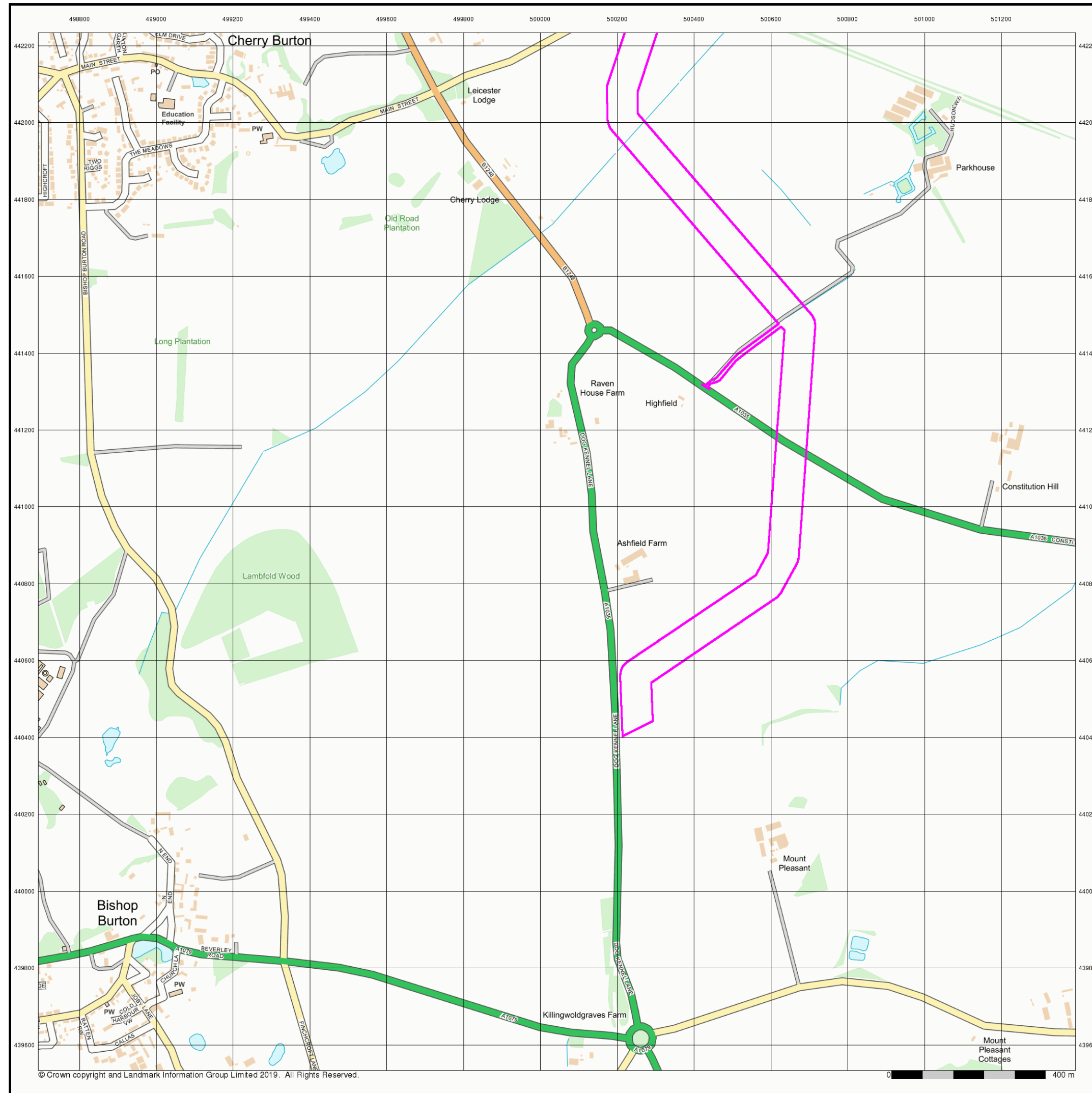

Street View

Published 2019

Source map scale - 1:10,000

Street View is a street-level map for the whole of Great Britain produced by the Ordnance Survey. These maps are provided at a nominal scale of 1:10,000

Map Name(s) and Date(s)

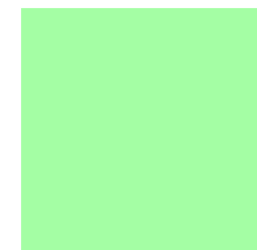

Street View Map - Slice B

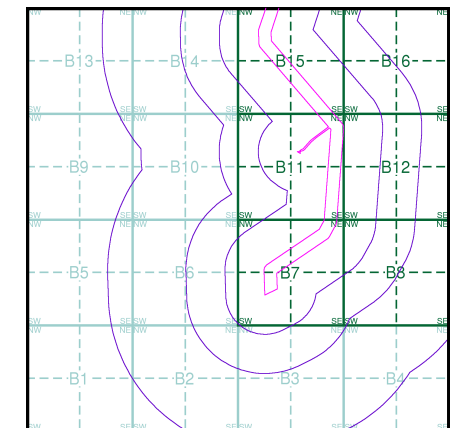

Order Details

Order Number: 201127560_1_1
 Customer Ref: PB8783-103-105
 National Grid Reference: 500310, 440950
 Slice: B
 Site Area (Ha): 53.73
 Search Buffer (m): 1000

Site Details

Hornsea Route

General

- Specified Site
- Specified Buffer(s)
- Bearing Reference Point
- Map ID
- Several of Type at Location

Agency and Hydrological

- Contaminated Land Register Entry or Notice (Location)
- Contaminated Land Register Entry or Notice
- Discharge Consent
- Enforcement or Prohibition Notice
- Integrated Pollution Control
- Integrated Pollution Prevention Control
- Local Authority Integrated Pollution Prevention and Control
- Local Authority Pollution Prevention and Control Enforcement
- Pollution Incident to Controlled Waters
- Prosecution Relating to Authorised Processes
- Prosecution Relating to Controlled Waters
- Registered Radioactive Substance
- River Network or Water Feature
- River Quality Sampling Point
- Substantiated Pollution Incident Register
- Water Abstraction
- Water Industry Act Referral

Waste

- BGS Recorded Landfill Site (Location)
- BGS Recorded Landfill Site
- EA Historic Landfill (Buffered Point)
- EA Historic Landfill (Polygon)
- Integrated Pollution Control Registered Waste Site
- Licensed Waste Management Facility (Landfill Boundary)
- Licensed Waste Management Facility (Location)
- Local Authority Recorded Landfill Site (Location)
- Local Authority Recorded Landfill Site
- Registered Landfill Site
- Registered Landfill Site (Location)
- Registered Landfill Site (Point Buffered to 100m)
- Registered Landfill Site (Point Buffered to 250m)
- Registered Waste Transfer Site (Location)
- Registered Waste Transfer Site
- Registered Waste Treatment or Disposal Site (Location)
- Registered Waste Treatment or Disposal Site

Geological

- BGS Recorded Mineral Site

Industrial Land Use

- Contemporary Trade Directory Entry
- Fuel Station Entry
- COMAH Site
- Explosive Site
- NIHHS Site
- Planning Hazardous Substance Consent
- Planning Hazardous Substance Enforcement

Site Sensitivity Map - Slice B

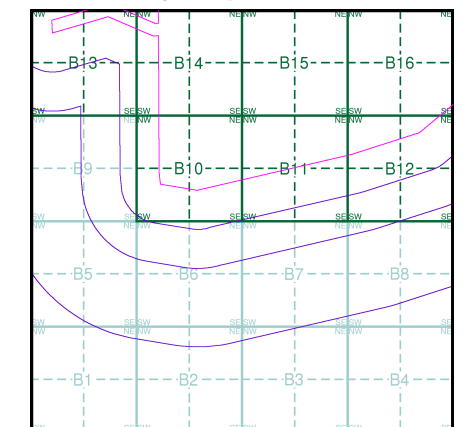

Order Details

Order Number: 201127462_1_1
 Customer Ref: PB8783-103-105
 National Grid Reference: 512510, 455610
 Slice: B
 Site Area (Ha): 2345.09
 Search Buffer (m): 1000



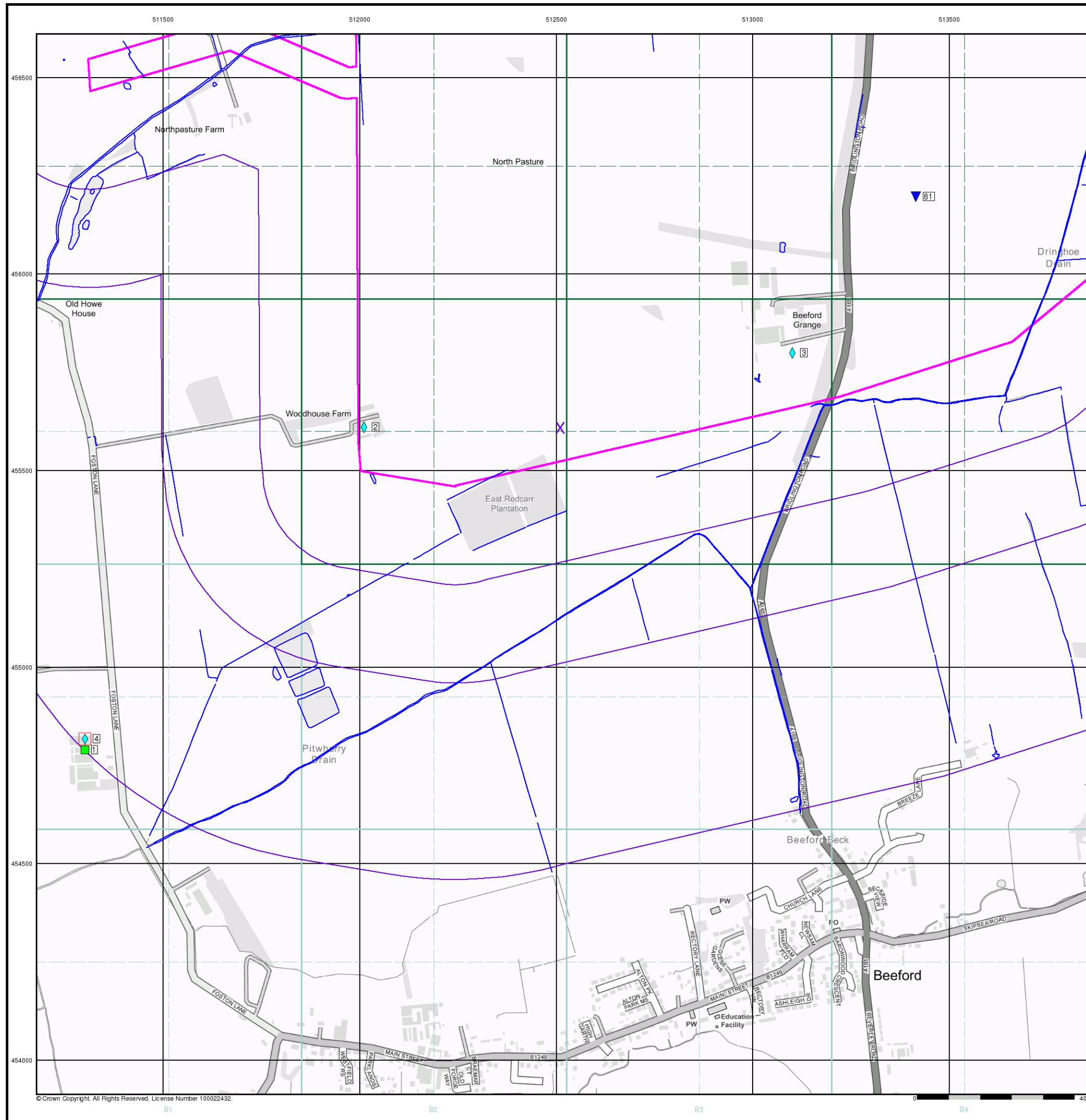

Site Details

Hornsea Route







Industrial Land Use Map

General

-  Specified Site
-  Specified Buffer(s)
-  Bearing Reference Point
-  Slice
-  Map ID

Industrial Land Use

-  Contemporary Trade Directory Entry
-  Fuel Station Entry
-  Gas Pipeline
-  Underground Electrical Cables

Industrial Land Use Map - Slice B

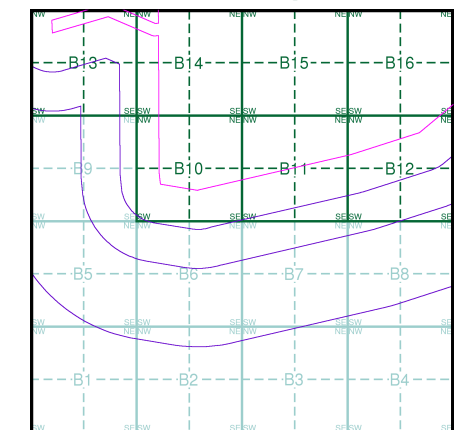

Order Details



Order Number: 201127462_1_1
 Customer Ref: PB8783-103-105
 National Grid Reference: 512510, 455610
 Slice: B
 Site Area (Ha): 2345.09
 Search Buffer (m): 1000

Site Details

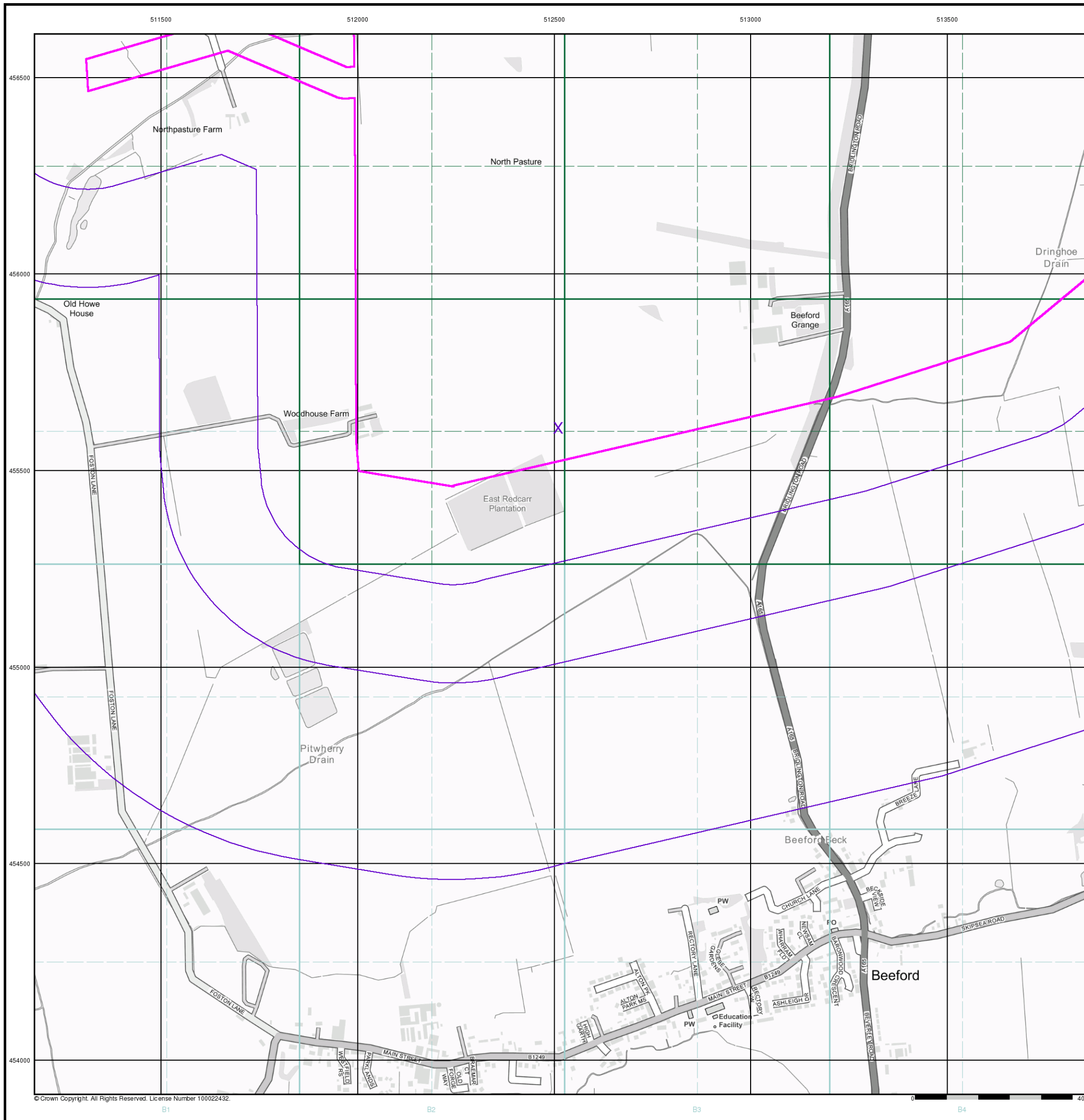



Hornsea Route



General

-  Specified Site
-  Specified Buffer(s)
-  Bearing Reference Point

Agency and Hydrological (Flood)

-  Extreme Flooding from Rivers or Sea without Defences (Zone 2)
-  Flooding from Rivers or Sea without Defences (Zone 3)
-  Area Benefiting from Flood Defence
-  Flood Water Storage Areas
-  Flood Defence

Flood Map - Slice B

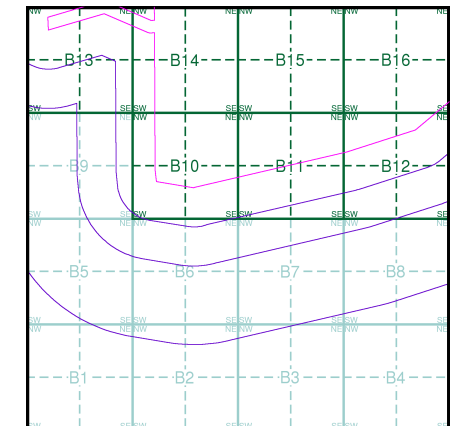

Order Details

Order Number: 201127462_1_1
 Customer Ref: PB8783-103-105
 National Grid Reference: 512510, 455610
 Slice: B
 Site Area (Ha): 2345.09
 Search Buffer (m): 1000

Site Details

Hornsea Route

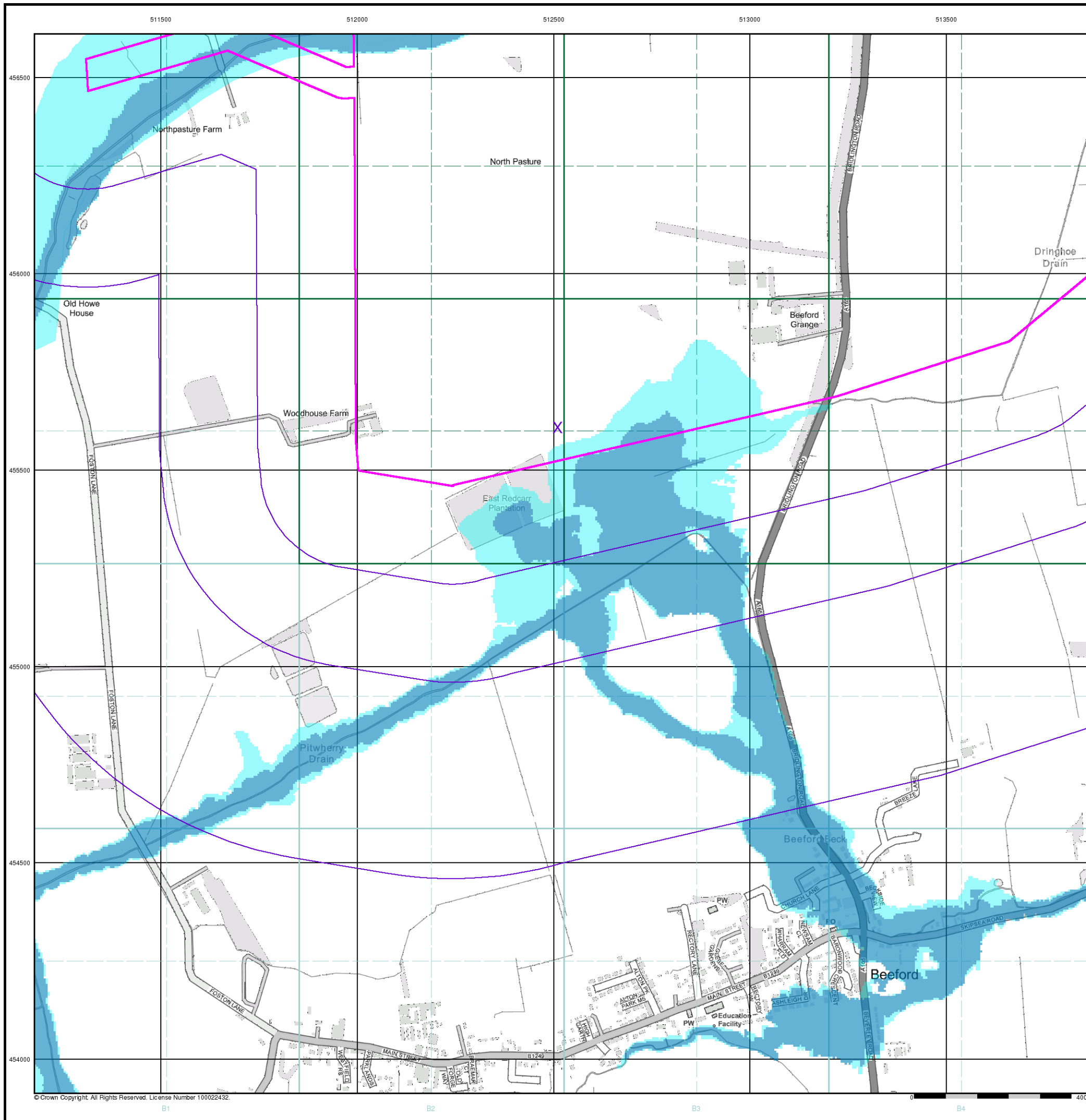

© Crown Copyright. All Rights Reserved. License Number 100022432.

General

- Specified Site
- Specified Buffer(s)
- Bearing Reference Point
- Map ID
- Several of Type at Location

Agency and Hydrological (Boreholes)

- BGS Borehole Depth 0 - 10m
- BGS Borehole Depth 10 - 30m
- BGS Borehole Depth 30m +
- Confidential
- Other

For Borehole information please refer to the Borehole .csv file which accompanied this slice.

A copy of the BGS Borehole Ordering Form is available to download from the Support section of www.envirocheck.co.uk.

Borehole Map - Slice B

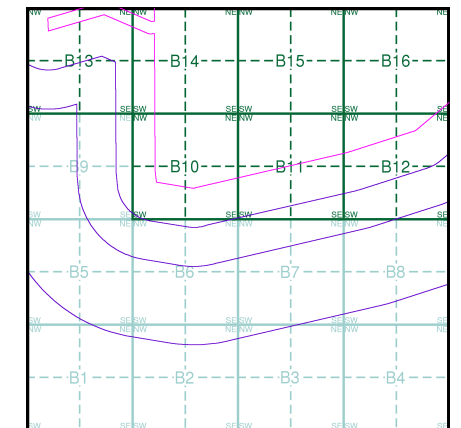

Order Details

Order Number: 201127462_1_1
 Customer Ref: PB8783-103-105
 National Grid Reference: 512510, 455610
 Slice: B
 Site Area (Ha): 2345.09
 Search Buffer (m): 1000

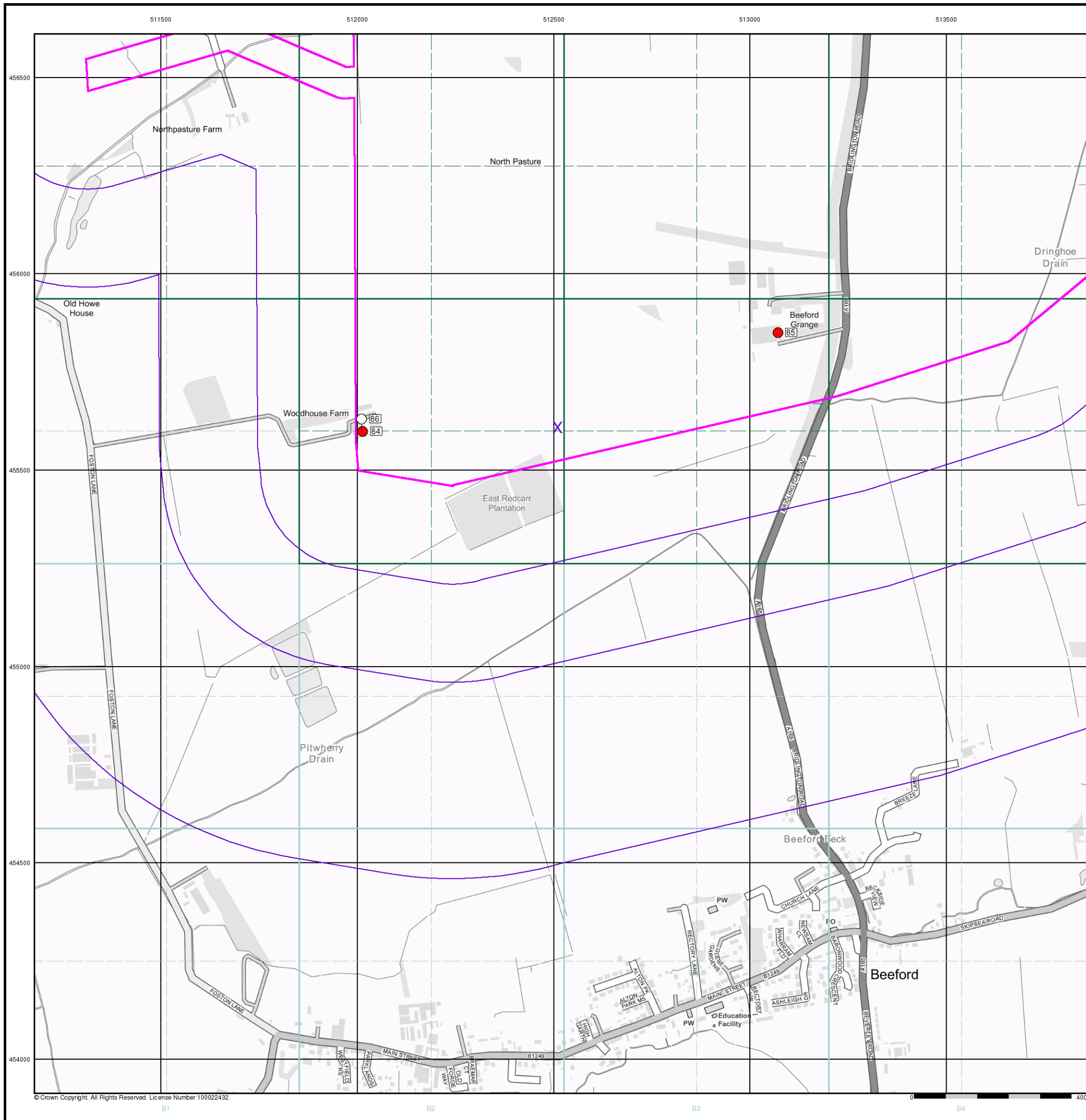

Site Details

Hornsea Route



© Crown Copyright. All Rights Reserved. License Number 100022432.

General

-  Specified Site
-  Specified Buffer(s)
-  Bearing Reference Point

OS Water Network Data

- | | |
|--|---|
|  Canal |  Drain |
|  Reservoir |  Other |
|  Foreshore |  Lake |
|  Marsh |  Transfer |
|  Tidal River |  Lock Or Flight Of Locks |
|  Inland River |  Sea |

OS Water Network Map - Slice B

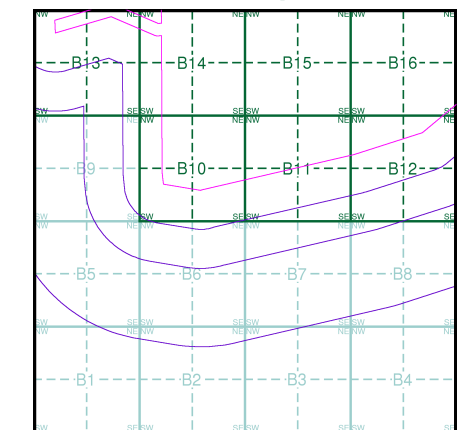

Order Details

Order Number: 201127462_1_1
 Customer Ref: PB8783-103-105
 National Grid Reference: 512510, 455610
 Slice: B
 Site Area (Ha): 2345.09
 Search Buffer (m): 1000

Site Details

Hornsea Route

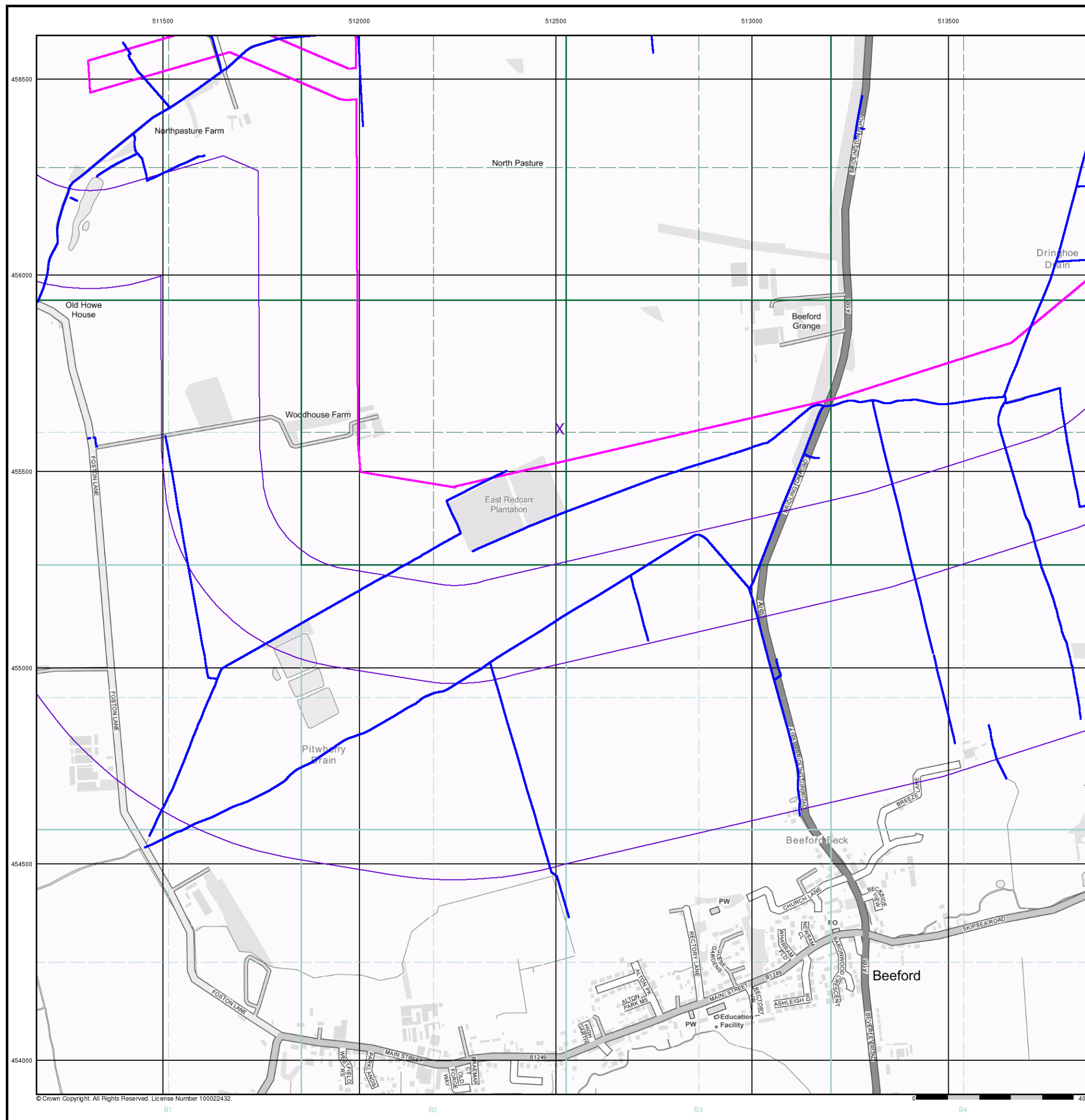

- General**
- Specified Site
 - Specified Buffer(s)
 - Bearing Reference Point
 - Map ID
 - Several of Type at Location
- Agency and Hydrological**
- Contaminated Land Register Entry or Notice (Location)
 - Contaminated Land Register Entry or Notice
 - Discharge Consent
 - Enforcement or Prohibition Notice
 - Integrated Pollution Control
 - Integrated Pollution Prevention Control
 - Local Authority Integrated Pollution Prevention and Control
 - Local Authority Pollution Prevention and Control Enforcement
 - Pollution Incident to Controlled Waters
 - Prosecution Relating to Authorised Processes
 - Prosecution Relating to Controlled Waters
 - Registered Radioactive Substance
 - River Network or Water Feature
 - River Quality Sampling Point
 - Substantiated Pollution Incident Register
 - Water Abstraction
 - Water Industry Act Referral
- Waste**
- BGS Recorded Landfill Site (Location)
 - BGS Recorded Landfill Site
 - EA Historic Landfill (Buffered Point)
 - EA Historic Landfill (Polygon)
 - Integrated Pollution Control Registered Waste Site
 - Licensed Waste Management Facility (Landfill Boundary)
 - Licensed Waste Management Facility (Location)
 - Local Authority Recorded Landfill Site (Location)
 - Local Authority Recorded Landfill Site
 - Registered Landfill Site
 - Registered Landfill Site (Location)
 - Registered Landfill Site (Point Buffered to 100m)
 - Registered Landfill Site (Point Buffered to 250m)
 - Registered Waste Transfer Site (Location)
 - Registered Waste Transfer Site
 - Registered Waste Treatment or Disposal Site (Location)
 - Registered Waste Treatment or Disposal Site
- Hazardous Substances**
- COMAH Site
 - Explosive Site
 - NIHHS Site
 - Planning Hazardous Substance Consent
 - Planning Hazardous Substance Enforcement
- Geological**
- BGS Recorded Mineral Site
- Industrial Land Use**
- Contemporary Trade Directory Entry
 - Fuel Station Entry

Site Sensitivity Map - Slice B

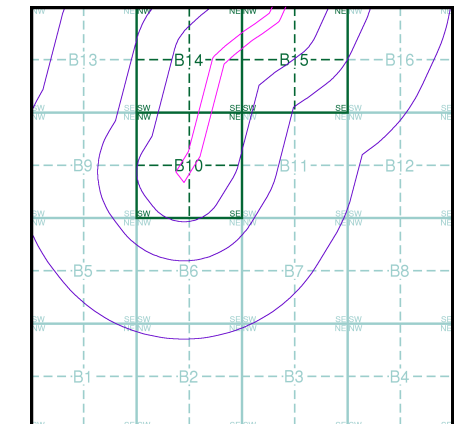

Order Details

Order Number: 201127465_1_1
 Customer Ref: PB8783-103-105
 National Grid Reference: 505970, 451130
 Slice: B
 Site Area (Ha): 72.
 Search Buffer (m): 1000



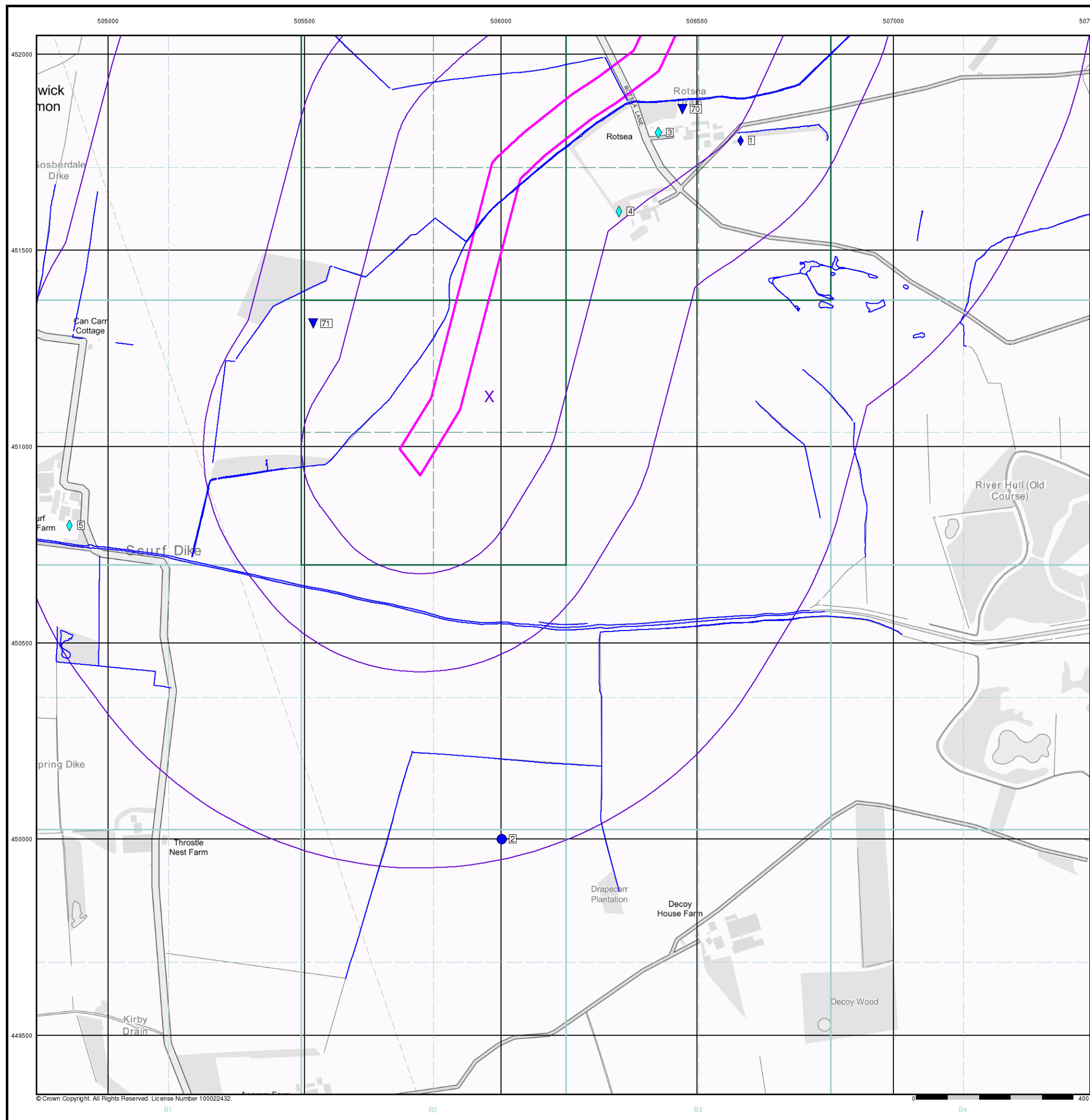

Site Details

Hornsea Route







Industrial Land Use Map

General

-  Specified Site
-  Specified Buffer(s)
-  Bearing Reference Point
-  Slice
-  Map ID

Industrial Land Use

-  Contemporary Trade Directory Entry
-  Fuel Station Entry
-  Gas Pipeline
-  Underground Electrical Cables

Industrial Land Use Map - Slice B

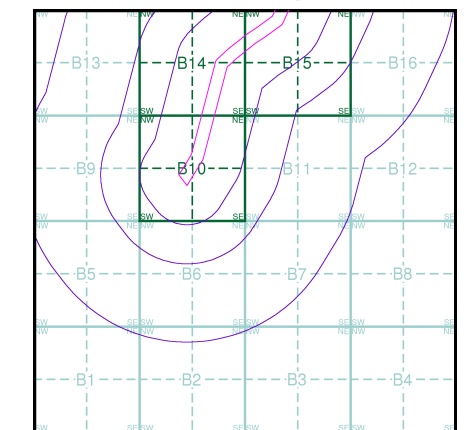

Order Details



Order Number: 201127465_1_1
 Customer Ref: PB8783-103-105
 National Grid Reference: 505970, 451130
 Slice: B
 Site Area (Ha): 72.
 Search Buffer (m): 1000

Site Details





Hornsea Route



General

-  Specified Site
-  Specified Buffer(s)
-  Bearing Reference Point

Agency and Hydrological (Flood)

-  Extreme Flooding from Rivers or Sea without Defences (Zone 2)
-  Flooding from Rivers or Sea without Defences (Zone 3)
-  Area Benefiting from Flood Defence
-  Flood Water Storage Areas
-  Flood Defence

Flood Map - Slice B

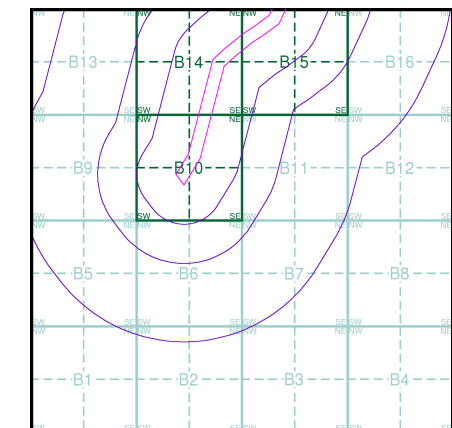

Order Details

Order Number: 201127465_1_1
 Customer Ref: PB8783-103-105
 National Grid Reference: 505970, 451130
 Slice: B
 Site Area (Ha): 72.
 Search Buffer (m): 1000

Site Details

Hornsea Route

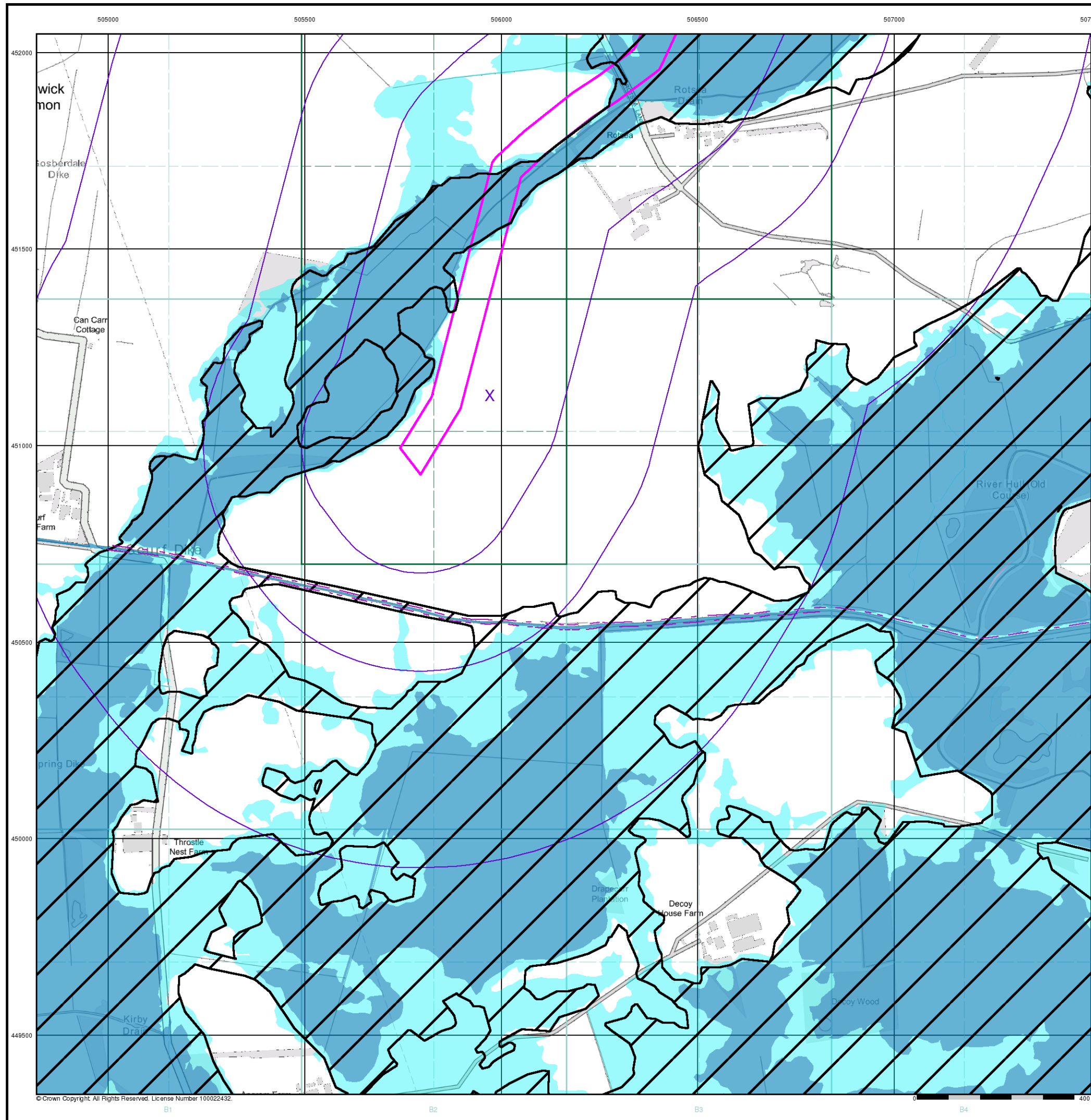

© Crown Copyright. All Rights Reserved. License Number 100022432.

General

- Specified Site
- Specified Buffer(s)
- Bearing Reference Point
- Map ID
- Several of Type at Location

Agency and Hydrological (Boreholes)

- BGS Borehole Depth 0 - 10m
- BGS Borehole Depth 10 - 30m
- BGS Borehole Depth 30m +
- Confidential
- Other

For Borehole information please refer to the Borehole .csv file which accompanied this slice.

A copy of the BGS Borehole Ordering Form is available to download from the Support section of www.envirocheck.co.uk.

Borehole Map - Slice B

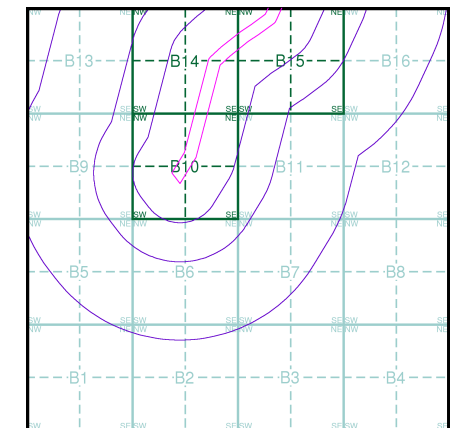

Order Details

Order Number: 201127465_1_1
 Customer Ref: PB8783-103-105
 National Grid Reference: 505970, 451130
 Slice: B
 Site Area (Ha): 72.
 Search Buffer (m): 1000

Site Details

Hornsea Route

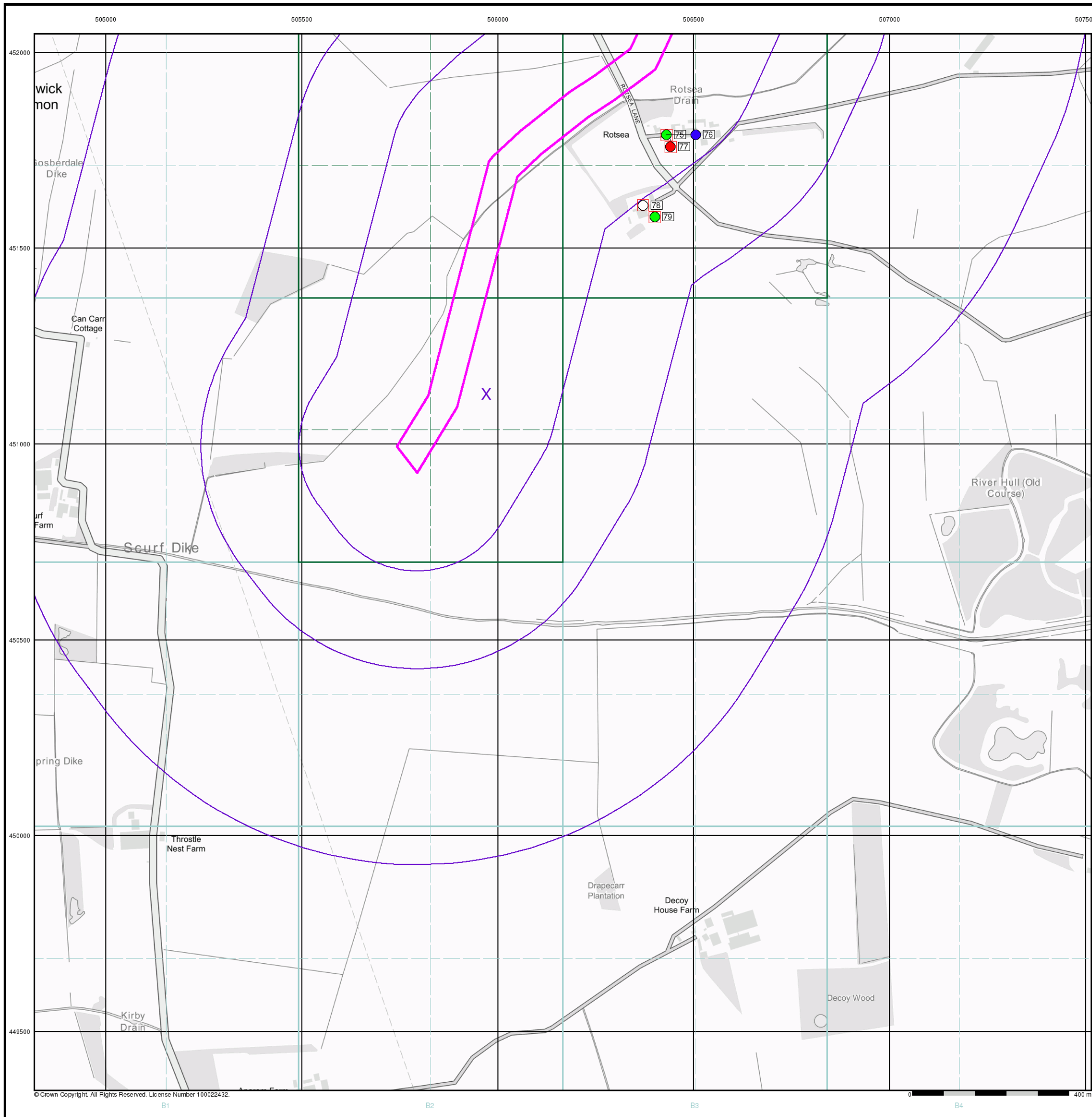

General

- Specified Site
- Specified Buffer(s)
- Bearing Reference Point

OS Water Network Data

- | | | | |
|--|--------------|--|-------------------------|
| | Canal | | Drain |
| | Reservoir | | Other |
| | Foreshore | | Lake |
| | Marsh | | Transfer |
| | Tidal River | | Lock Or Flight Of Locks |
| | Inland River | | Sea |

OS Water Network Map - Slice B

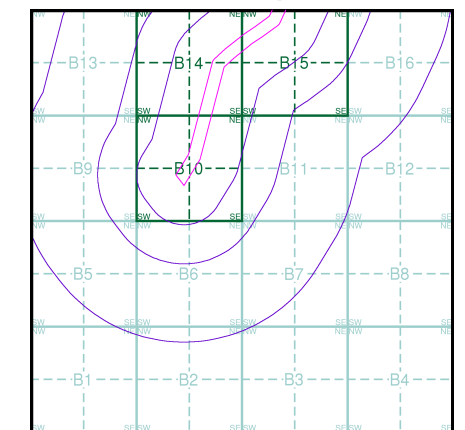

Order Details

Order Number: 201127465_1_1
 Customer Ref: PB8783-103-105
 National Grid Reference: 505970, 451130
 Slice: B
 Site Area (Ha): 72.
 Search Buffer (m): 1000

Site Details

Hornsea Route

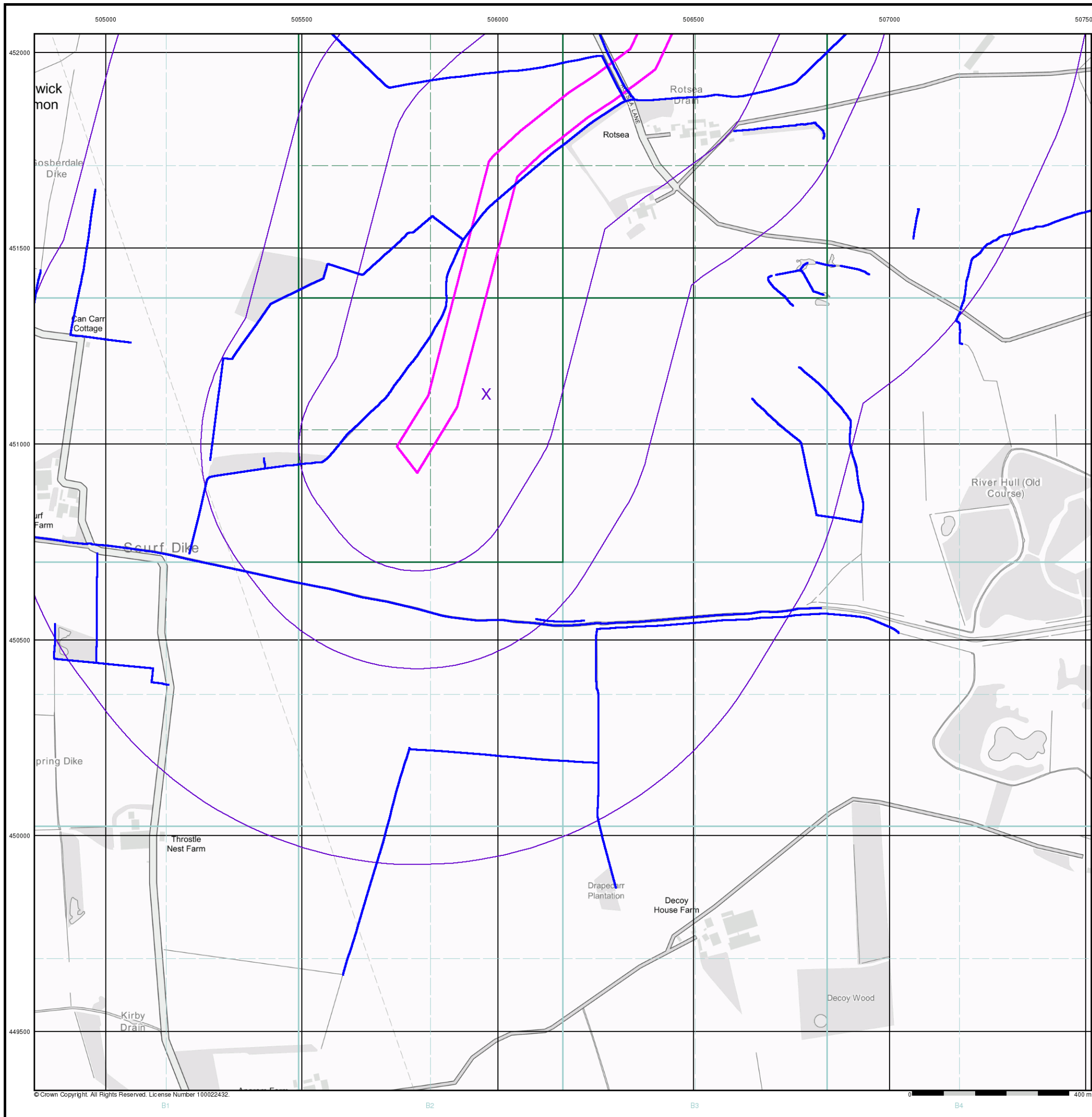

© Crown Copyright. All Rights Reserved. License Number 100022432.

General

- ◆ Specified Site
- Specified Buffer(s)
- X Bearing Reference Point
- Map ID
- Several of Type at Location

Agency and Hydrological

- Contaminated Land Register Entry or Notice (Location)
- Contaminated Land Register Entry or Notice
- ◆ Discharge Consent
- ▲ Enforcement or Prohibition Notice
- ▲ Integrated Pollution Control
- Integrated Pollution Prevention Control
- Local Authority Integrated Pollution Prevention and Control
- ▲ Local Authority Pollution Prevention and Control
- ▼ Local Authority Pollution Prevention and Control Enforcement
- Pollution Incident to Controlled Waters
- ▼ Prosecution Relating to Authorised Processes
- ◆ Prosecution Relating to Controlled Waters
- ▲ Registered Radioactive Substance
- + River Network or Water Feature
- + River Quality Sampling Point
- Substantiated Pollution Incident Register
- ◆ Water Abstraction
- ◆ Water Industry Act Referral

Waste

- ▼ BGS Recorded Landfill Site (Location)
- BGS Recorded Landfill Site
- EA Historic Landfill (Buffered Point)
- EA Historic Landfill (Polygon)
- ▲ Integrated Pollution Control Registered Waste Site
- Licensed Waste Management Facility (Landfill Boundary)
- Licensed Waste Management Facility (Location)
- Local Authority Recorded Landfill Site (Location)
- Local Authority Recorded Landfill Site
- Registered Landfill Site
- ▲ Registered Landfill Site (Location)
- Registered Landfill Site (Point Buffered to 100m)
- Registered Landfill Site (Point Buffered to 250m)
- Registered Waste Transfer Site (Location)
- Registered Waste Transfer Site
- Registered Waste Treatment or Disposal Site (Location)
- Registered Waste Treatment or Disposal Site

Geological

- ▼ BGS Recorded Mineral Site

Industrial Land Use

- ★ Contemporary Trade Directory Entry
- ★ Fuel Station Entry
- X COMAH Site
- X Explosive Site
- X NIHS Site
- X Planning Hazardous Substance Consent
- X Planning Hazardous Substance Enforcement

Site Sensitivity Map - Slice B

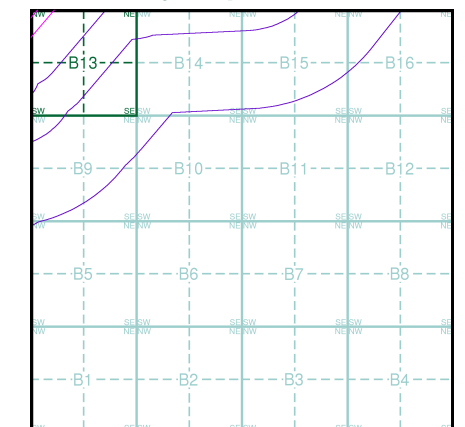

Order Details

Order Number: 201127555_1_1
 Customer Ref: PB8783-103-105
 National Grid Reference: 502940, 446720
 Slice: B
 Site Area (Ha): 62.79
 Search Buffer (m): 1000



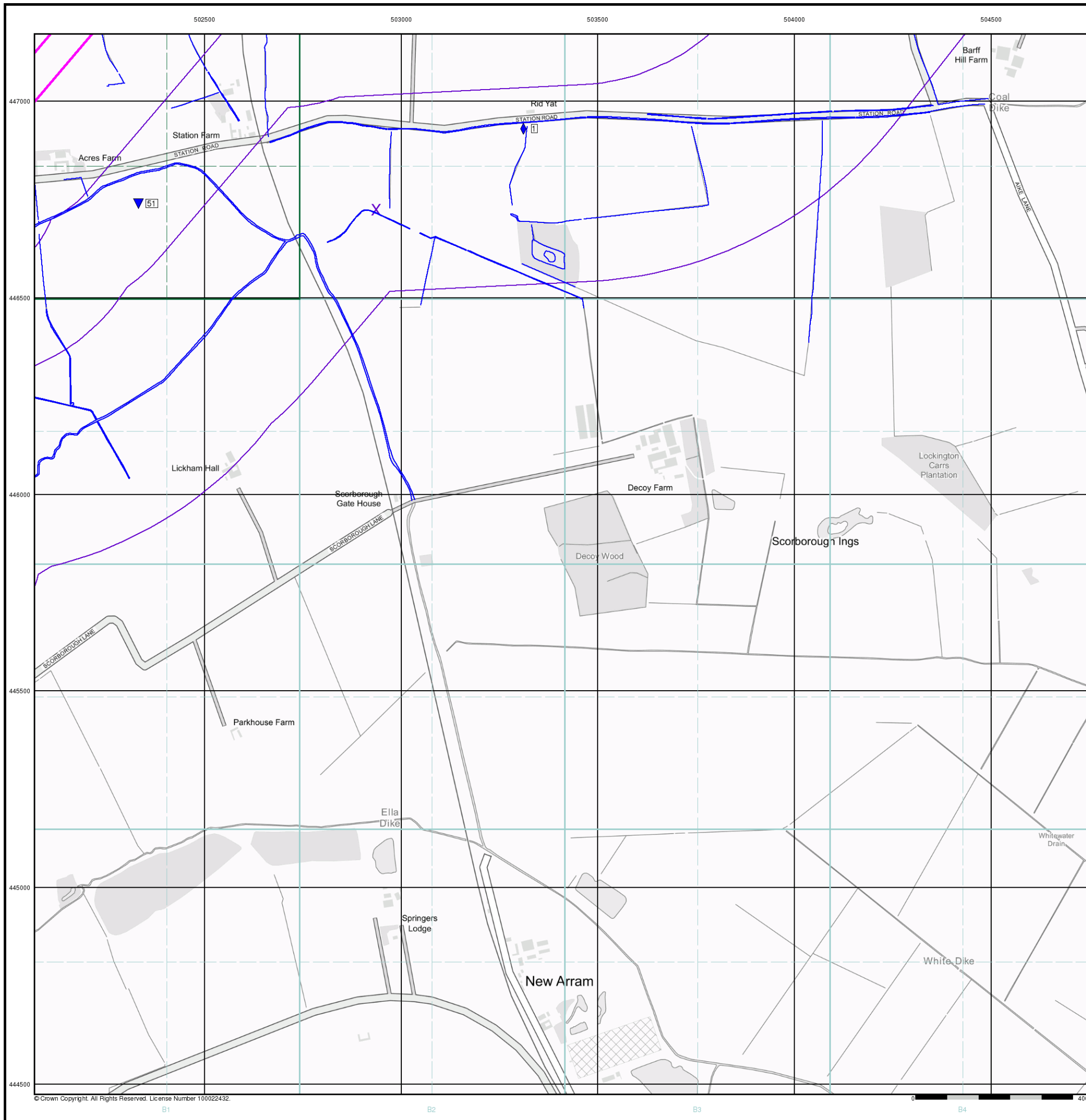

Site Details

Hornsea Route







Industrial Land Use Map

General

-  Specified Site
-  Specified Buffer(s)
-  Bearing Reference Point
-  Slice
-  Map ID

Industrial Land Use

-  Contemporary Trade Directory Entry
-  Fuel Station Entry
-  Gas Pipeline
-  Underground Electrical Cables

Industrial Land Use Map - Slice B

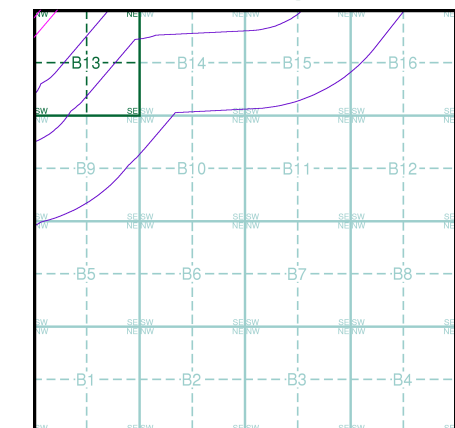

Order Details



Order Number: 201127555_1_1
 Customer Ref: PB8783-103-105
 National Grid Reference: 502940, 446720
 Slice: B
 Site Area (Ha): 62.79
 Search Buffer (m): 1000

Site Details

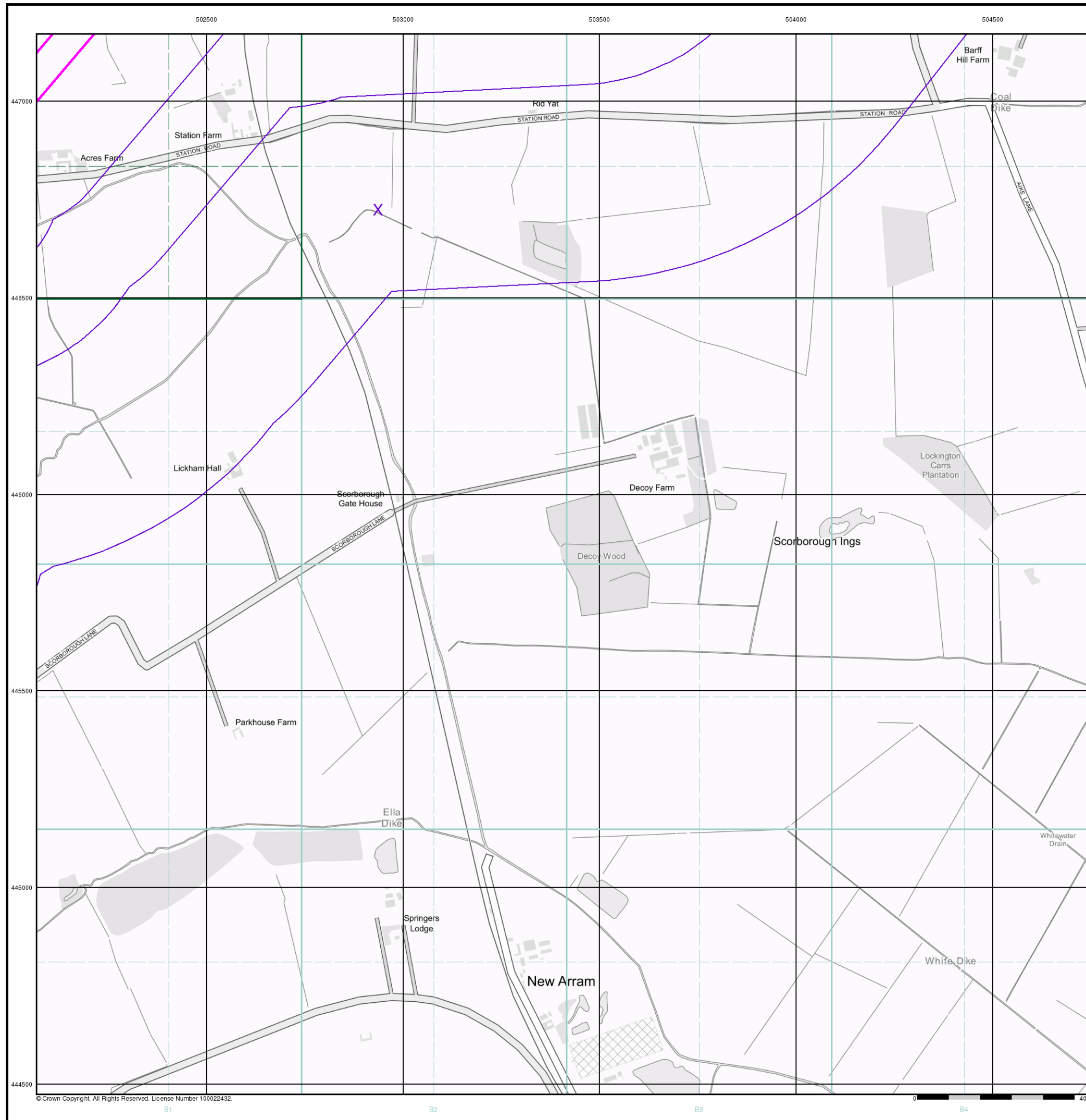



Hornsea Route



General

-  Specified Site
-  Specified Buffer(s)
-  Bearing Reference Point

Agency and Hydrological (Flood)

-  Extreme Flooding from Rivers or Sea without Defences (Zone 2)
-  Flooding from Rivers or Sea without Defences (Zone 3)
-  Area Benefiting from Flood Defence
-  Flood Water Storage Areas
-  Flood Defence

Flood Map - Slice B

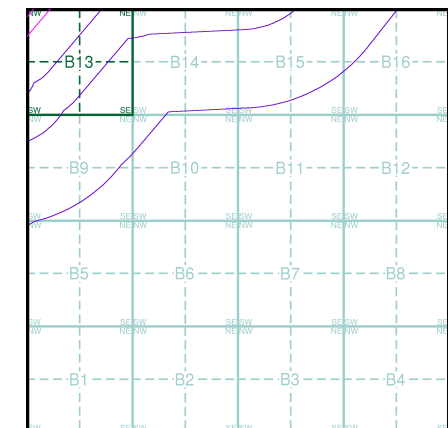

Order Details

Order Number: 201127555_1_1
 Customer Ref: PB8783-103-105
 National Grid Reference: 502940, 446720
 Slice: B
 Site Area (Ha): 62.79
 Search Buffer (m): 1000



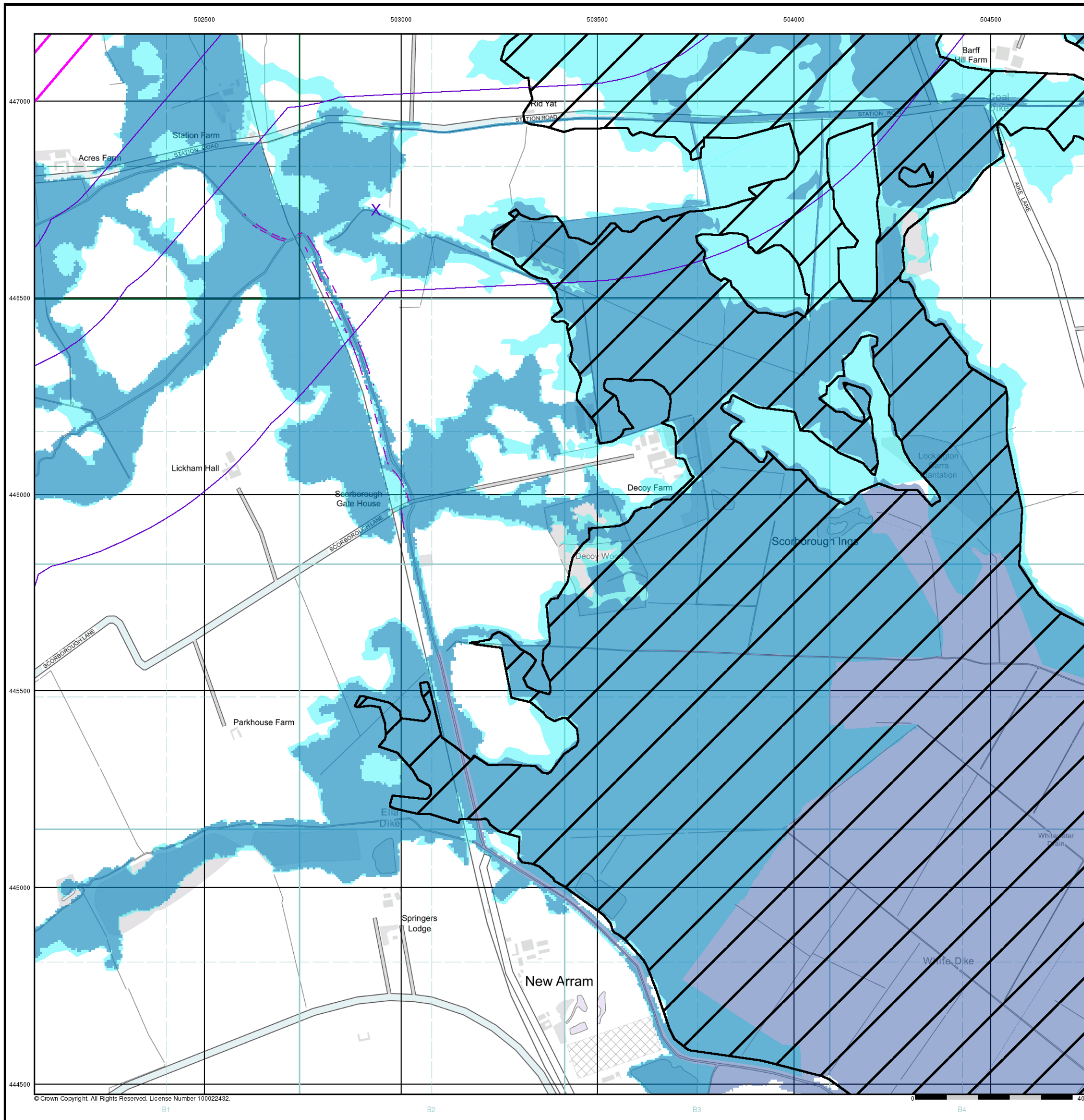

Site Details

Hornsea Route







© Crown Copyright. All Rights Reserved. License Number 100022432.

General

-  Specified Site
-  Specified Buffer(s)
-  Bearing Reference Point
-  Map ID
-  Several of Type at Location

Agency and Hydrological (Boreholes)

-  BGS Borehole Depth 0 - 10m
-  BGS Borehole Depth 10 - 30m
-  BGS Borehole Depth 30m +
-  Confidential
-  Other

For Borehole information please refer to the Borehole .csv file which accompanied this slice.

A copy of the BGS Borehole Ordering Form is available to download from the Support section of www.envirocheck.co.uk.

Borehole Map - Slice B

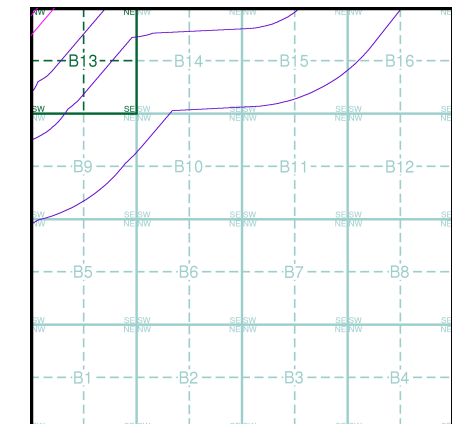

Order Details



Order Number: 201127555_1_1
 Customer Ref: PB8783-103-105
 National Grid Reference: 502940, 446720
 Slice: B
 Site Area (Ha): 62.79
 Search Buffer (m): 1000

Site Details

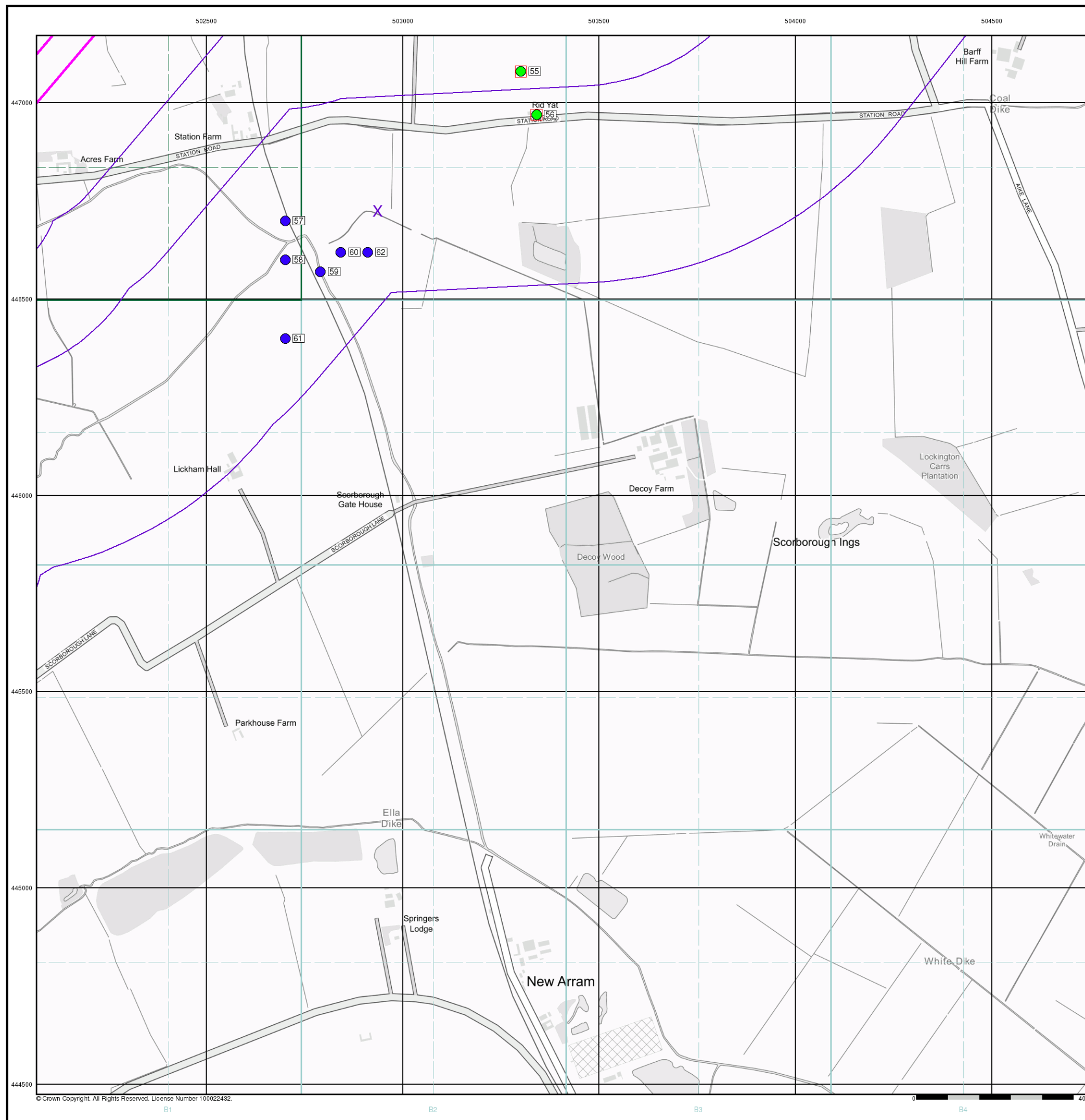
Hornsea Route



General

-  Specified Site
-  Specified Buffer(s)
-  Bearing Reference Point

OS Water Network Data

- | | |
|--|---|
|  Canal |  Drain |
|  Reservoir |  Other |
|  Foreshore |  Lake |
|  Marsh |  Transfer |
|  Tidal River |  Lock Or Flight Of Locks |
|  Inland River |  Sea |

OS Water Network Map - Slice B

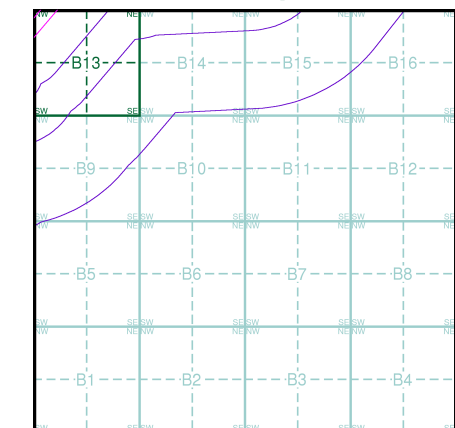

Order Details

Order Number: 201127555_1_1
 Customer Ref: PB8783-103-105
 National Grid Reference: 502940, 446720
 Slice: B
 Site Area (Ha): 62.79
 Search Buffer (m): 1000

Site Details

Hornsea Route

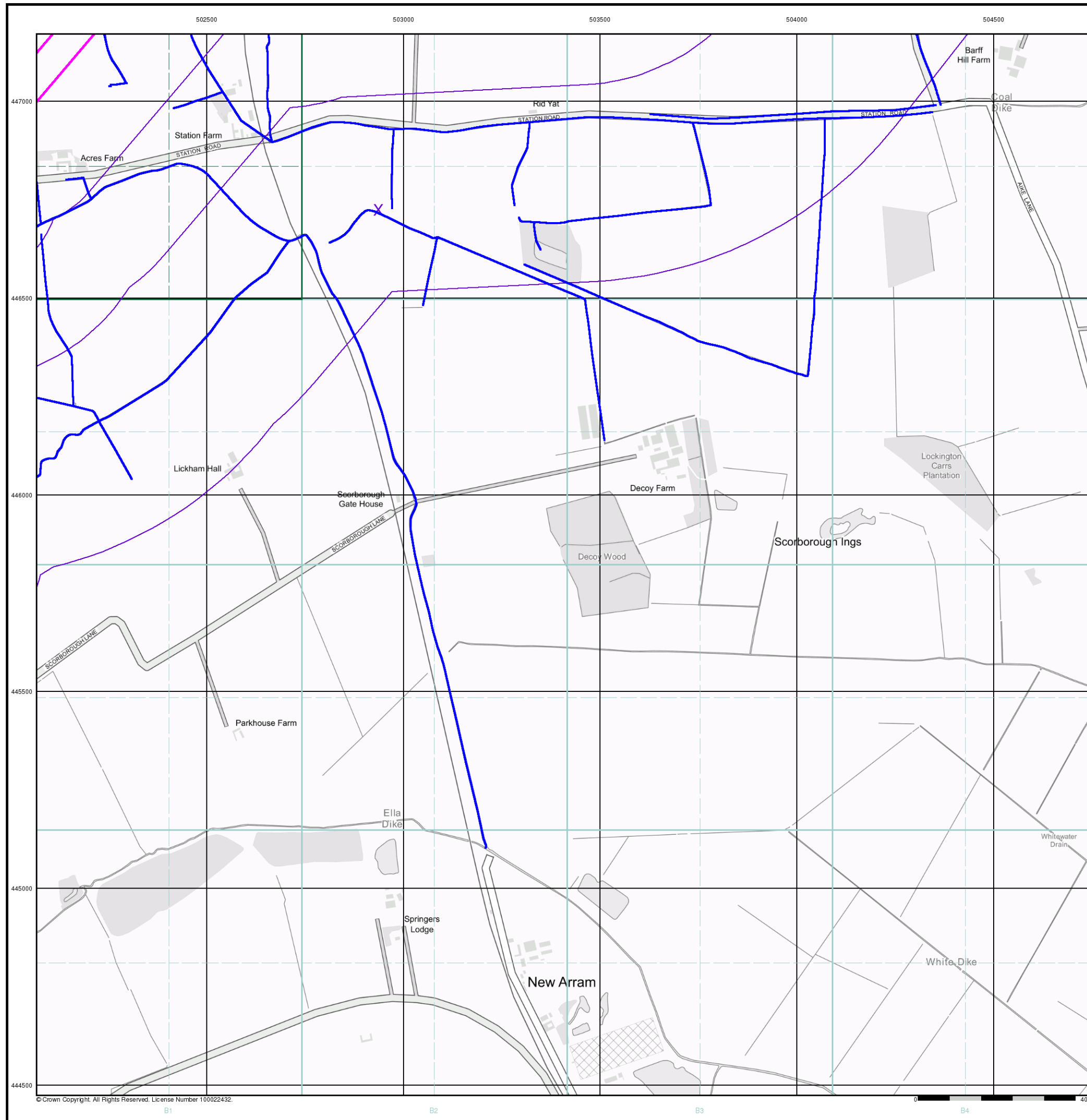

© Crown Copyright. All Rights Reserved. License Number 100022432.

General

- Specified Site
- Specified Buffer(s)
- X Bearing Reference Point
- B Map ID
- Several of Type at Location

Agency and Hydrological

- Contaminated Land Register Entry or Notice (Location)
- Contaminated Land Register Entry or Notice (Buffered Point)
- Discharge Consent
- ▲ Enforcement or Prohibition Notice
- ▲ Integrated Pollution Control
- ▲ Integrated Pollution Prevention Control
- ▲ Local Authority Integrated Pollution Prevention and Control
- ▲ Local Authority Pollution Prevention and Control Enforcement
- ▲ Pollution Incident to Controlled Waters
- ▲ Prosecution Relating to Authorised Processes
- ▲ Prosecution Relating to Controlled Waters
- ▲ Registered Radioactive Substance
- + River Network or Water Feature
- + River Quality Sampling Point
- + Substantiated Pollution Incident Register
- + Water Abstraction
- + Water Industry Act Referral

Waste

- ▼ BGS Recorded Landfill Site (Location)
- ▼ BGS Recorded Landfill Site (Buffered Point)
- EA Historic Landfill (Buffered Point)
- EA Historic Landfill (Polygon)
- ▲ Integrated Pollution Control Registered Waste Site
- ▲ Licensed Waste Management Facility (Landfill Boundary)
- ▲ Licensed Waste Management Facility (Location)
- ▲ Local Authority Recorded Landfill Site (Location)
- ▲ Local Authority Recorded Landfill Site (Buffered Point)
- ▲ Registered Landfill Site
- ▲ Registered Landfill Site (Location)
- ▲ Registered Landfill Site (Point Buffered to 100m)
- ▲ Registered Landfill Site (Point Buffered to 250m)
- ▲ Registered Waste Transfer Site (Location)
- ▲ Registered Waste Transfer Site
- ▲ Registered Waste Treatment or Disposal Site (Location)
- ▲ Registered Waste Treatment or Disposal Site

Geological

- ▼ BGS Recorded Mineral Site

Industrial Land Use

- ★ Contemporary Trade Directory Entry
- ★ Fuel Station Entry
- X COMAH Site
- X Explosive Site
- X NIHS Site
- X Planning Hazardous Substance Consent
- X Planning Hazardous Substance Enforcement

Site Sensitivity Map - Slice B

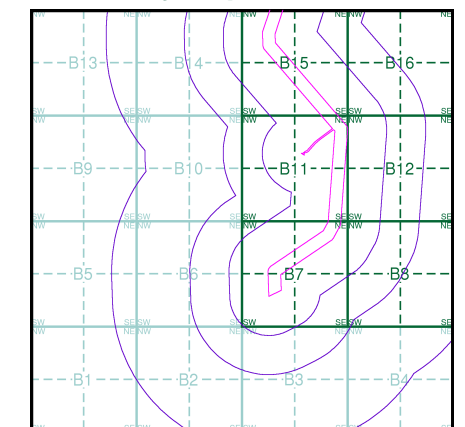

Order Details

Order Number: 201127560_1_1
 Customer Ref: PB8783-103-105
 National Grid Reference: 500310, 440950
 Slice: B
 Site Area (Ha): 53.73
 Search Buffer (m): 1000

Site Details



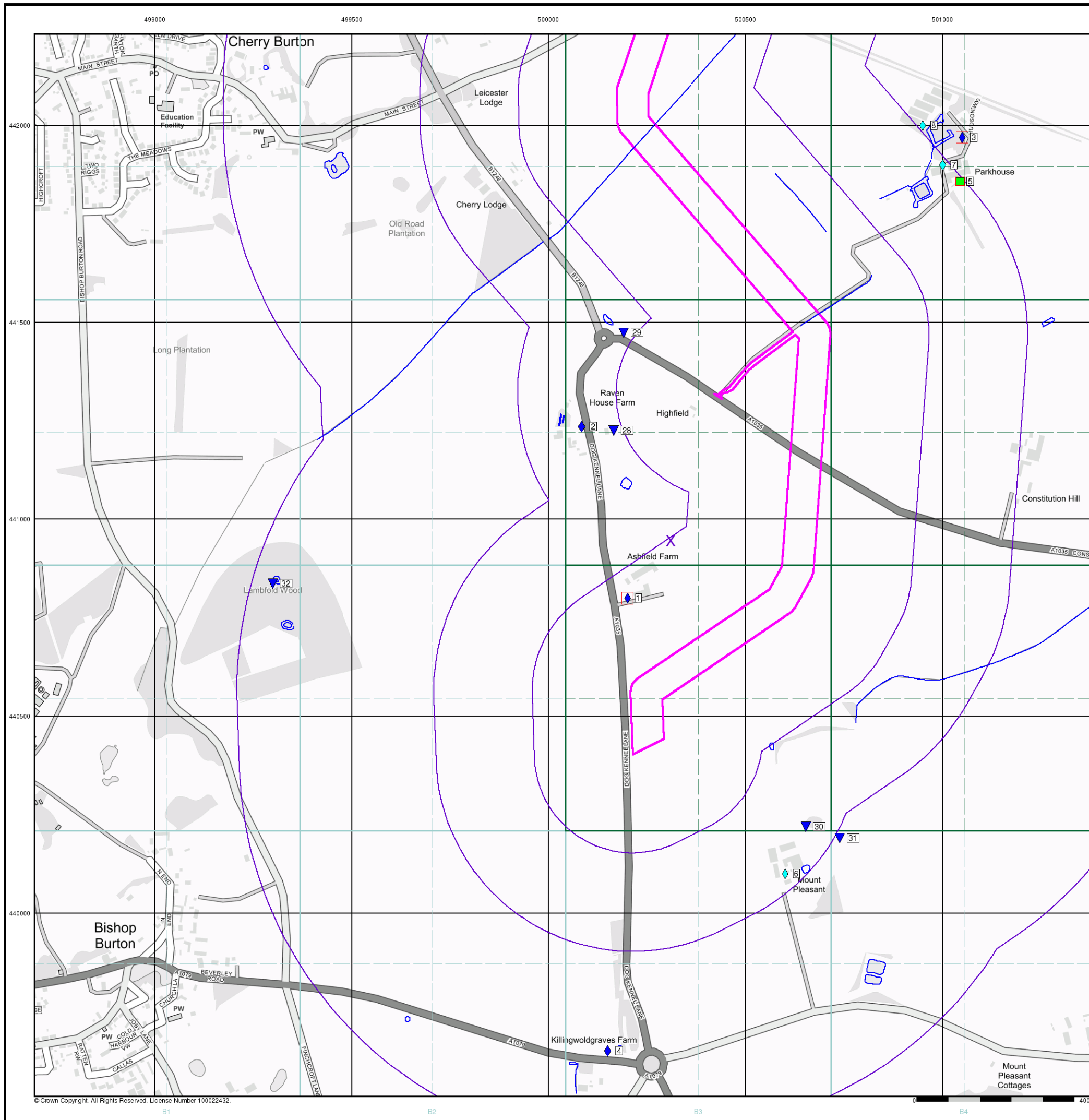

Hornsea Route







© Crown Copyright. All Rights Reserved. License Number 100022432.

Industrial Land Use Map

General

-  Specified Site
-  Specified Buffer(s)
-  Bearing Reference Point
-  Slice
-  Map ID

Industrial Land Use

-  Contemporary Trade Directory Entry
-  Fuel Station Entry
-  Gas Pipeline
-  Underground Electrical Cables

Industrial Land Use Map - Slice B

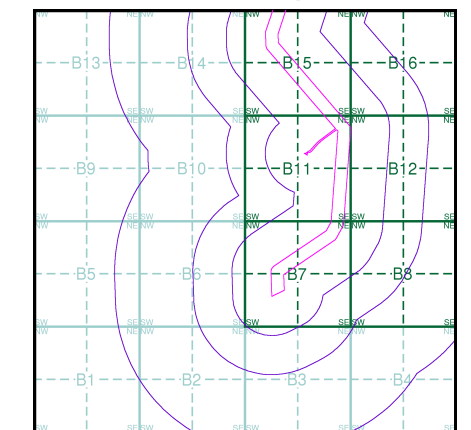

Order Details



Order Number: 201127560_1_1
 Customer Ref: PB8783-103-105
 National Grid Reference: 500310, 440950
 Slice: B
 Site Area (Ha): 53.73
 Search Buffer (m): 1000

Site Details

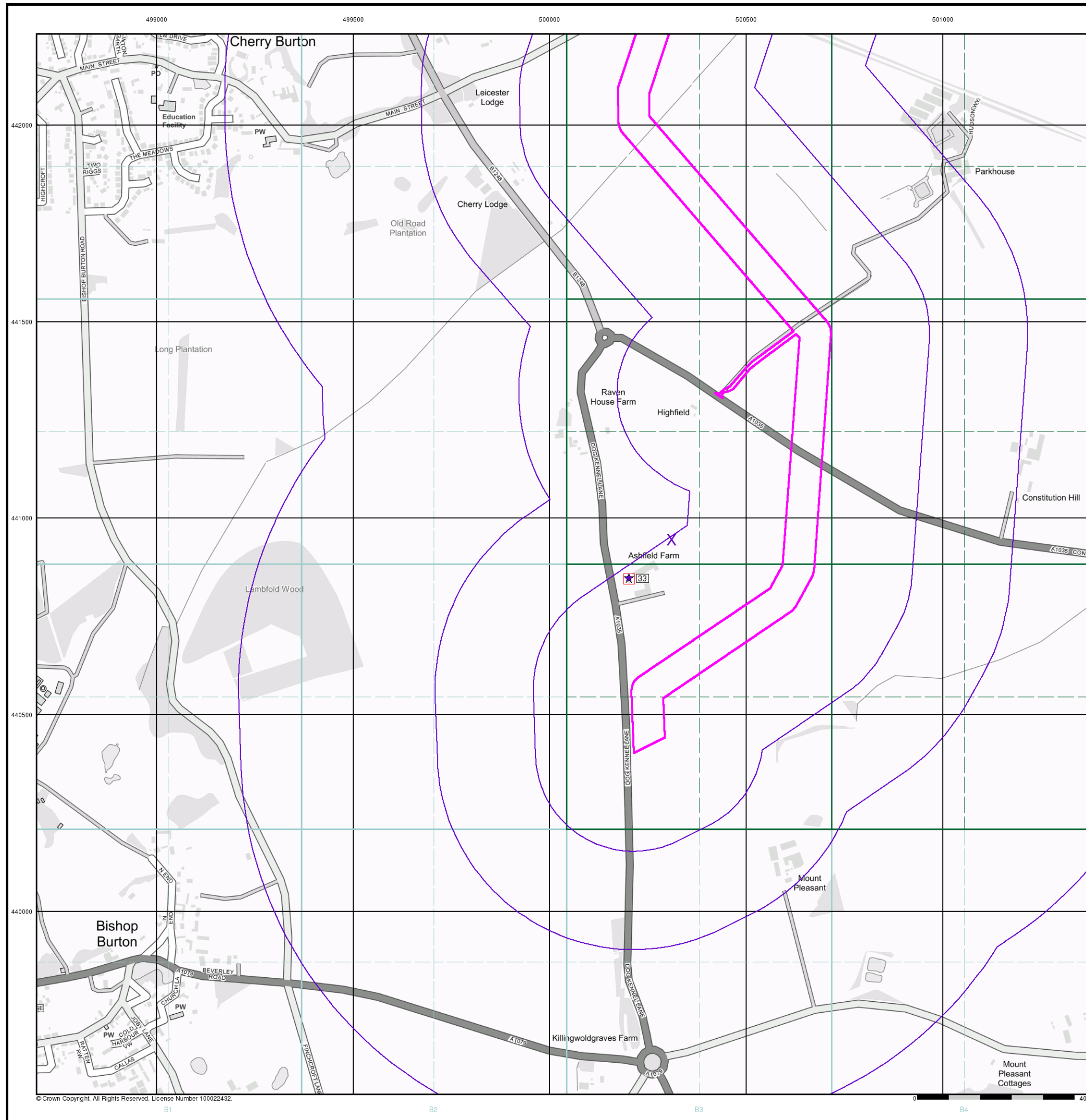



Hornsea Route



General

-  Specified Site
-  Specified Buffer(s)
-  Bearing Reference Point

Agency and Hydrological (Flood)

-  Extreme Flooding from Rivers or Sea without Defences (Zone 2)
-  Flooding from Rivers or Sea without Defences (Zone 3)
-  Area Benefiting from Flood Defence
-  Flood Water Storage Areas
-  Flood Defence

Flood Map - Slice B

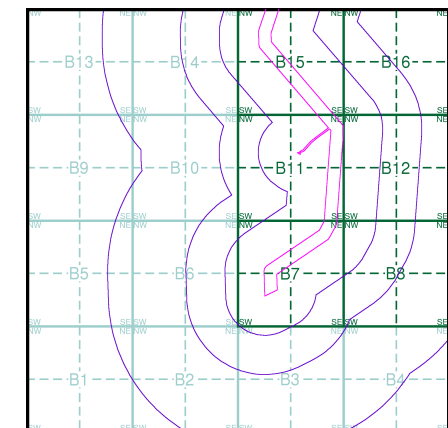

Order Details

Order Number: 201127560_1_1
 Customer Ref: PB8783-103-105
 National Grid Reference: 500310, 440950
 Slice: B
 Site Area (Ha): 53.73
 Search Buffer (m): 1000

Site Details

Hornsea Route



© Crown Copyright. All Rights Reserved. License Number 100022432.

General

- ▭ Specified Site
- ▭ Specified Buffer(s)
- X Bearing Reference Point
- Map ID
- Several of Type at Location

Agency and Hydrological (Boreholes)

- BGS Borehole Depth 0 - 10m
- BGS Borehole Depth 10 - 30m
- BGS Borehole Depth 30m +
- Confidential
- Other

For Borehole information please refer to the Borehole .csv file which accompanied this slice.

A copy of the BGS Borehole Ordering Form is available to download from the Support section of www.envirocheck.co.uk.

Borehole Map - Slice B

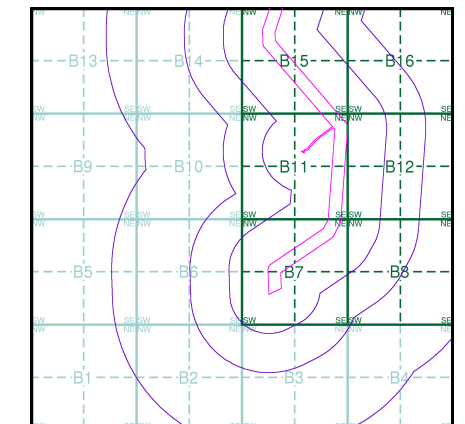

Order Details

Order Number: 201127560_1_1
 Customer Ref: PB8783-103-105
 National Grid Reference: 500310, 440950
 Slice: B
 Site Area (Ha): 53.73
 Search Buffer (m): 1000

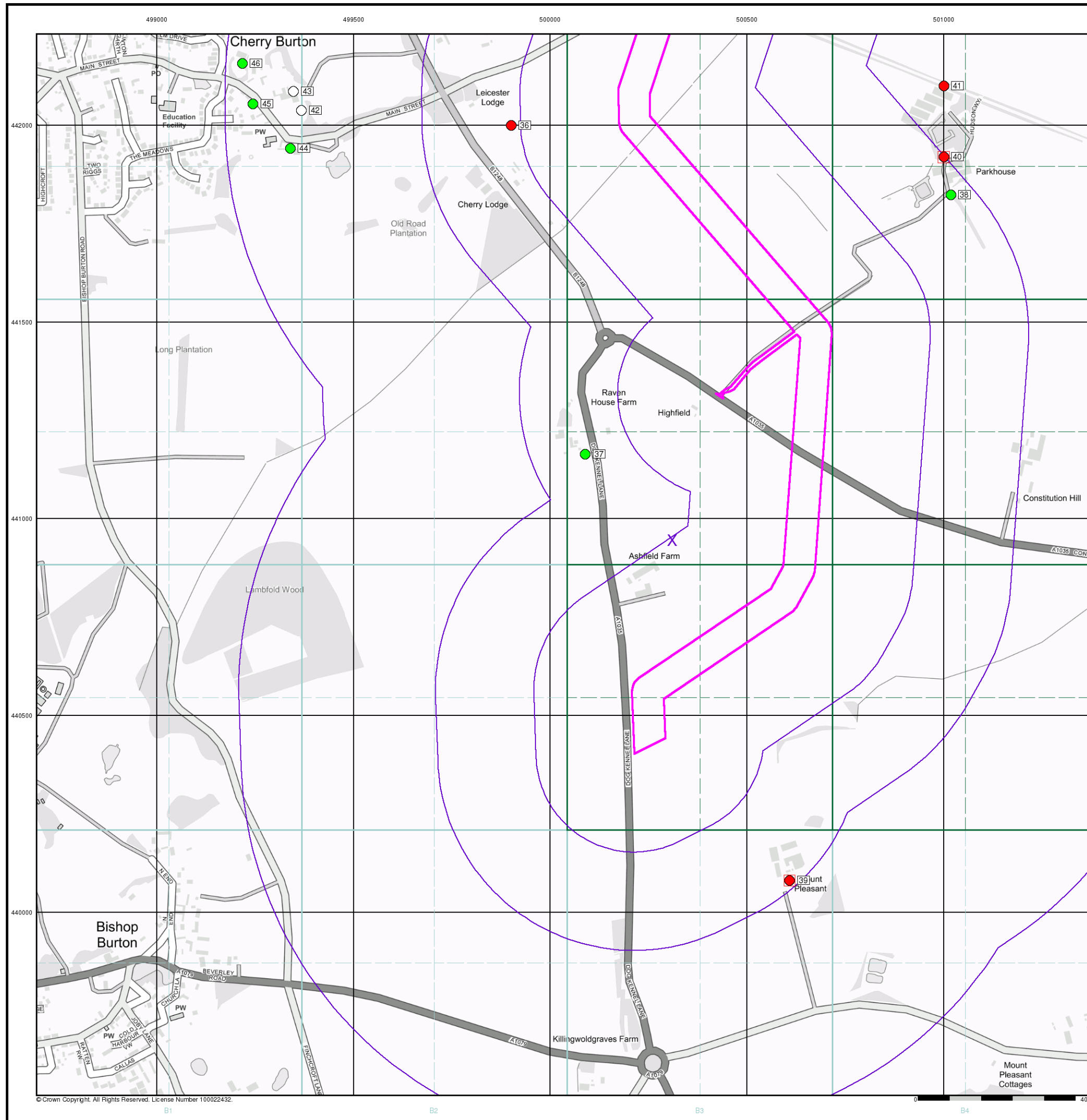

Site Details

Hornsea Route



© Crown Copyright. All Rights Reserved. License Number 100022432.

General

-  Specified Site
-  Specified Buffer(s)
-  Bearing Reference Point

OS Water Network Data

- | | |
|--|---|
|  Canal |  Drain |
|  Reservoir |  Other |
|  Foreshore |  Lake |
|  Marsh |  Transfer |
|  Tidal River |  Lock Or Flight Of Locks |
|  Inland River |  Sea |

OS Water Network Map - Slice B

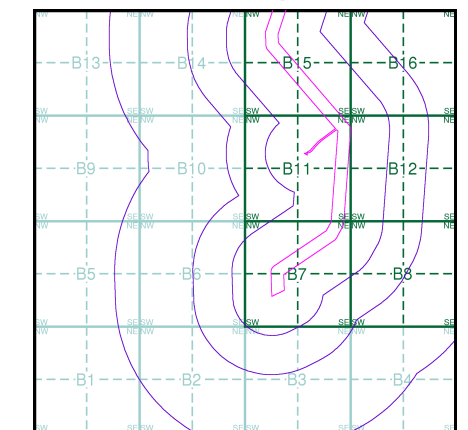

Order Details

Order Number: 201127560_1_1
 Customer Ref: PB8783-103-105
 National Grid Reference: 500310, 440950
 Slice: B
 Site Area (Ha): 53.73
 Search Buffer (m): 1000

Site Details

Hornsea Route

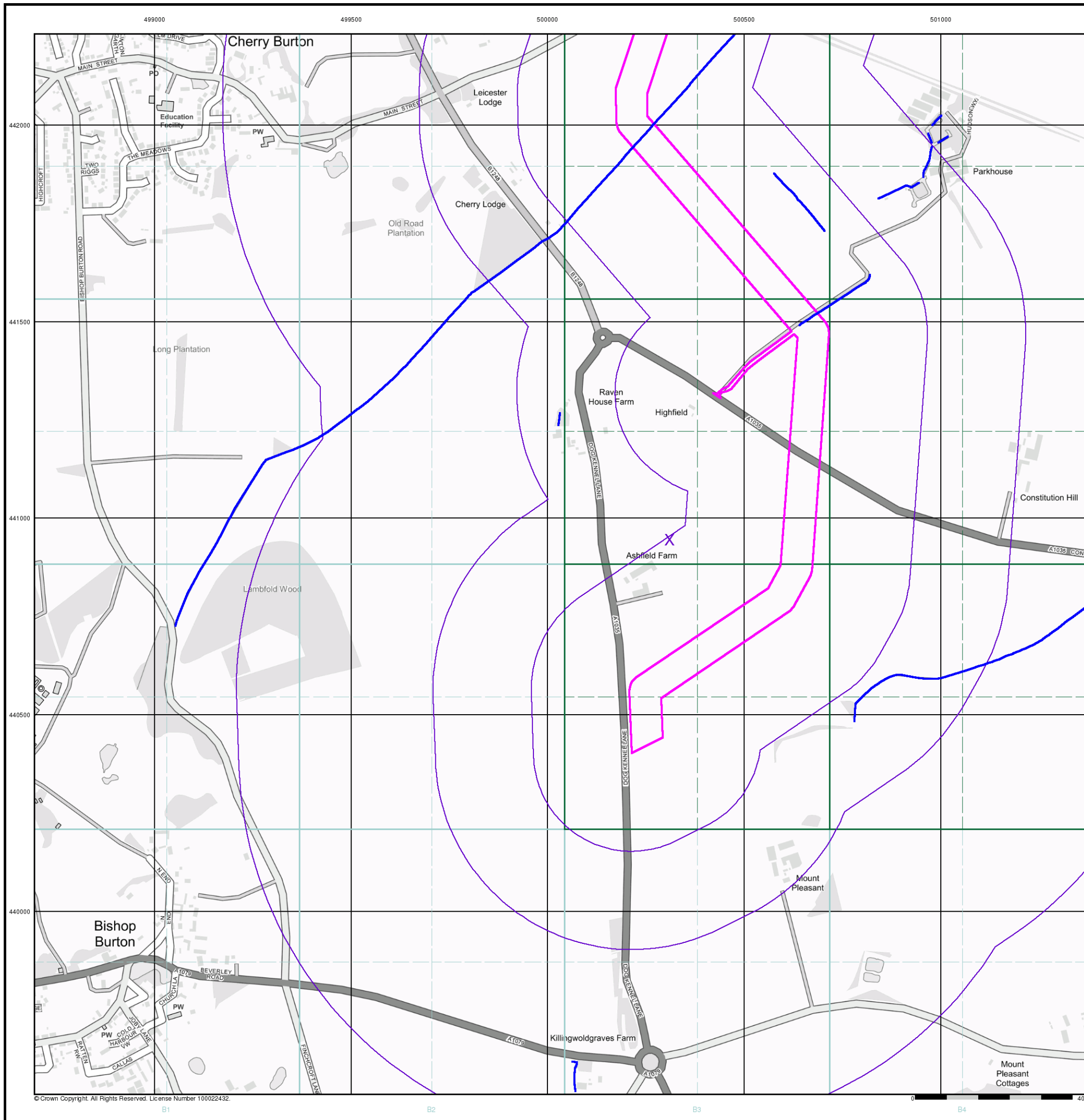

Historical Mapping Legends

Ordnance Survey County Series and Ordnance Survey Plan 1:2,500

Quarry **Gravel Pit** **Sand Pit**
Clay Pit **Shingle** **Refuse Heap**
Sloping Masonry **Flat Rock**
Marsh **Reeds** **Osiers**
Rough Pasture **Furze** **Wood**
Mixed Wood **Brushwood** **Orchard**
Fir **Ford** **Stepping Stones**
Ferry **Waterfall** **Lock**
Trig. Station **Altitude at Trig. Station**
B.M. 325.9 **Bench Mark** **Surface Level**
Arrow denotes flow of water **Antiquities (site of)**
Cutting **Embankment**
Railway crossing Road **Level Crossing** **Road crossing Railway**
Railway crossing River or Canal **Road over single stream** **Road over River or Canal**
County Boundary (Geographical)
County & Civil Parish Boundary
Administrative County & Civil Parish Boundary
County Borough Boundary (England)
County Burgh Boundary (Scotland)
Boundary Post or Stone **Police Call Box**
B.R. Bridle Road **Pump**
E.P. Electricity Pylon **S.P. Signal Post**
F.B. Foot Bridge **Sl. Sluice**
F.P. Foot Path **Sp. Spring**
G.P. Guide Post or Board **T.C.B. Telephone Call Box**
M.S. Mile Stone **Tr. Trough**
M.P. M.R. Mooring Post or Ring **W. Well**

Ordnance Survey Plan, Additional SIMs and Supply of Unpublished Survey Information 1:2,500 and 1:1,250

Inactive Quarry, Chalk Pit or Clay Pit **Active Quarry, Chalk Pit or Clay Pit**
Rock **Boulders**
Cliff **Slopes** **Top**
Roofed Building **Glazed Roof Building**
Sloping Masonry **Archway**
Non-Coniferous Tree (surveyed) **Coniferous Tree (surveyed)**
Non-Coniferous Trees (not surveyed) **Coniferous Trees (not surveyed)**
Orchard Tree **Scrub** **Bracken**
Coppice, Osier **Reeds** **Marsh, Saltings**
Rough Grassland **Heath** **Culvert**
Direction of water flow **Bench Mark** **Antiquity (site of)**
Cave Entrance **Triangulation Station** **Electricity Pylon**
Electricity Transmission Line
County Boundary (Geographical)
County & Civil Parish Boundary
Civil Parish Boundary
Admin. County or County Bor. Boundary
London Borough Boundary
Symbol marking point where boundary mereing changes
BH Beer House **P Pillar, Pole or Post**
BP, BS Boundary Post or Stone **PO Post Office**
Cn, C Capstan, Crane **PC Public Convenience**
Chy Chimney **PH Public House**
D Fn Drinking Fountain **Pp Pump**
EI P Electricity Pillar or Post **SB, S Br Signal Box or Bridge**
FAP Fire Alarm Pillar **SP, SL Signal Post or Light**
FB Foot Bridge **Spr Spring**
GP Guide Post **Tk Tank or Track**
H Hydrant or Hydraulic **TCB Telephone Call Box**
LC Level Crossing **TCP Telephone Call Post**
MH Manhole **Tr Trough**
MP Mile Post or Mooring Post **Wr Pt, Wr T Water Point, Water Tap**
MS Mile Stone **W Well**
NTL Normal Tidal Limit **Wd Pp Wind Pump**

Large-Scale National Grid Data 1:2,500 and 1:1,250

Cliff **Slopes** **Top**
Rock **Rock (scattered)**
Boulders **Boulders (scattered)**
Positioned Boulder **Scree**
Non-Coniferous Tree (surveyed) **Coniferous Tree (surveyed)**
Non-Coniferous Trees (not surveyed) **Coniferous Trees (not surveyed)**
Orchard Tree **Scrub** **Bracken**
Coppice, Osier **Reeds** **Marsh, Saltings**
Rough Grassland **Heath** **Culvert**
Direction of water flow **Triangulation Station** **Antiquity (site of)**
Electricity Transmission Line **Electricity Pylon**
Bench Mark **Buildings with Building Seed**
Roofed Building **Glazed Roof Building**
Civil parish/community boundary
District boundary
County boundary
Boundary post/stone
Boundary mereing symbol (note: these always appear in opposed pairs or groups of three)
Bks Barracks **P Pillar, Pole or Post**
Bty Battery **PO Post Office**
Cemy Cemetery **PC Public Convenience**
Chy Chimney **Pp Pump**
Cis Cistern **Ppg Sta Pumping Station**
Dismtd Rly Dismantled Railway **PW Place of Worship**
EI Gen Sta Electricity Generating Station **Sewage Ppg Sta Sewage Pumping Station**
EI P Electricity Pole, Pillar **SB, S Br Signal Box or Bridge**
EI Sub Sta Electricity Sub Station **SP, SL Signal Post or Light**
FB Filter Bed **Spr Spring**
Fn / D Fn Fountain / Drinking Ftn. **Tk Tank or Track**
Gas Gov Gas Valve Compound **Tr Trough**
GVC Gas Governor **Wd Pp Wind Pump**
GP Guide Post **Wr Pt, Wr T Water Point, Water Tap**
MH Manhole **Wks Works (building or area)**
MP, MS Mile Post or Mile Stone **W Well**

Envirocheck

LANDMARK INFORMATION GROUP

Historical Mapping & Photography included:

Mapping Type	Scale	Date	Pg
Yorkshire	1:2,500	1892	2
Yorkshire	1:2,500	1910	3
Ordnance Survey Plan	1:2,500	1975	4
Large-Scale National Grid Data	1:2,500	1995	5

Historical Map - Segment C3

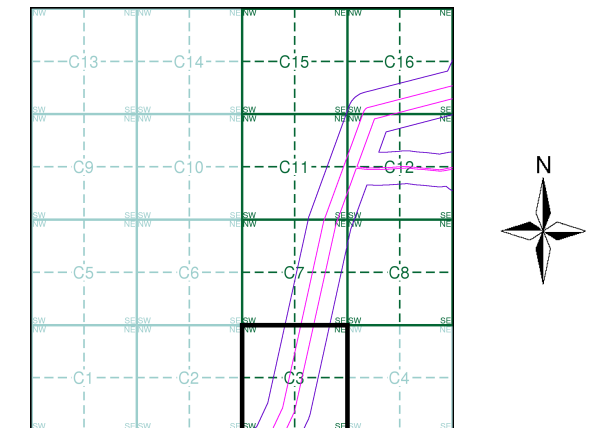

Order Details

Order Number: 201127465_1_1
 Customer Ref: PB8783-103-105
 National Grid Reference: 506560, 453280
 Slice: C
 Site Area (Ha): 72.
 Search Buffer (m): 100

Site Details

Hornsea Route

Landmark
 INFORMATION GROUP

Tel: 0844 844 9952
 Fax: 0844 844 9951
 Web: www.envirocheck.co.uk

Yorkshire

Published 1892

Source map scale - 1:2,500

The historical maps shown were reproduced from maps predominantly held at the scale adopted for England, Wales and Scotland in the 1840's. In 1854 the 1:2,500 scale was adopted for mapping urban areas and by 1896 it covered the whole of what were considered to be the cultivated parts of Great Britain. The published date given below is often some years later than the surveyed date. Before 1938, all OS maps were based on the Cassini Projection, with independent surveys of a single county or group of counties, giving rise to significant inaccuracies in outlying areas.

Map Name(s) and Date(s)

179_05 1892 1:2,500	179_06 1892 1:2,500
179_09 1892 1:2,500	179_10 1892 1:2,500

Historical Map - Segment C3

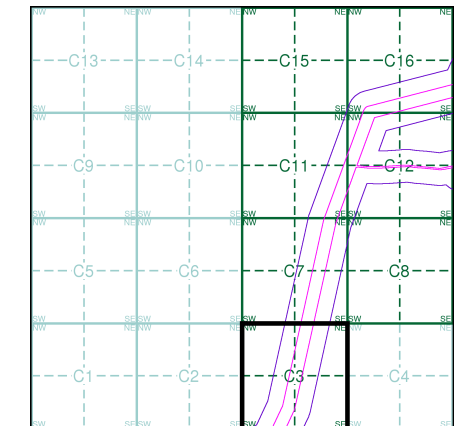

Order Details

Order Number: 201127465_1_1
 Customer Ref: PB8783-103-105
 National Grid Reference: 506560, 453280
 Slice: C
 Site Area (Ha): 72.
 Search Buffer (m): 100

Site Details

Hornsea Route

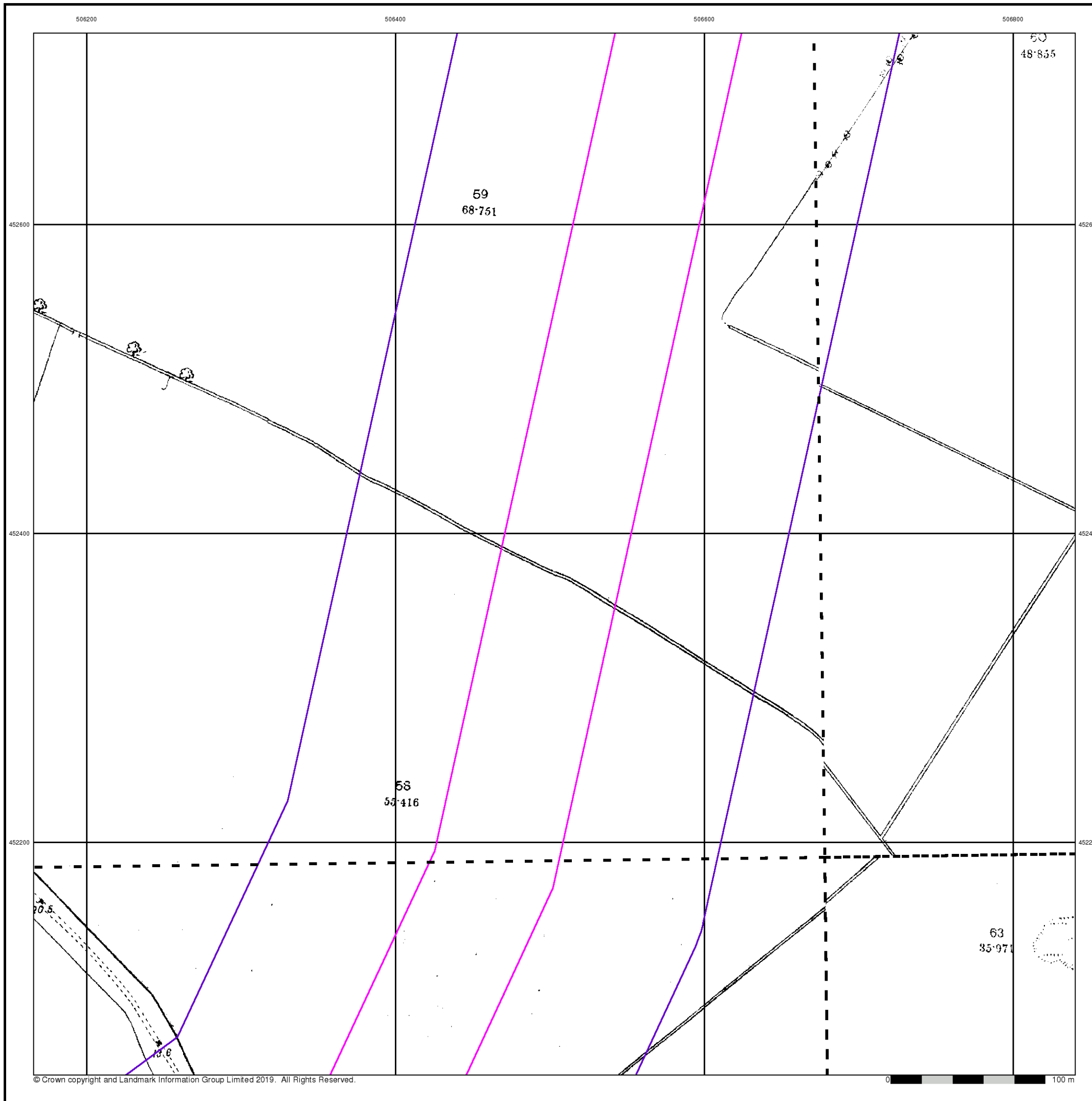

The historical maps shown were reproduced from maps predominantly held at the scale adopted for England, Wales and Scotland in the 1840's. In 1854 the 1:2,500 scale was adopted for mapping urban areas and by 1896 it covered the whole of what were considered to be the cultivated parts of Great Britain. The published date given below is often some years later than the surveyed date. Before 1938, all OS maps were based on the Cassini Projection, with independent surveys of a single county or group of counties, giving rise to significant inaccuracies in outlying areas.

Map Name(s) and Date(s)

179_05 1910 1:2,500	179_06 1910 1:2,500
179_09 1910 1:2,500	

Historical Map - Segment C3

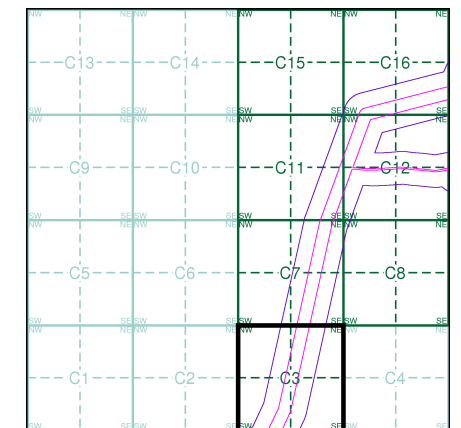

Order Details

Order Number: 201127465_1_1
 Customer Ref: PB8783-103-105
 National Grid Reference: 506560, 453280
 Slice: C
 Site Area (Ha): 72.
 Search Buffer (m): 100

Site Details

Hornsea Route

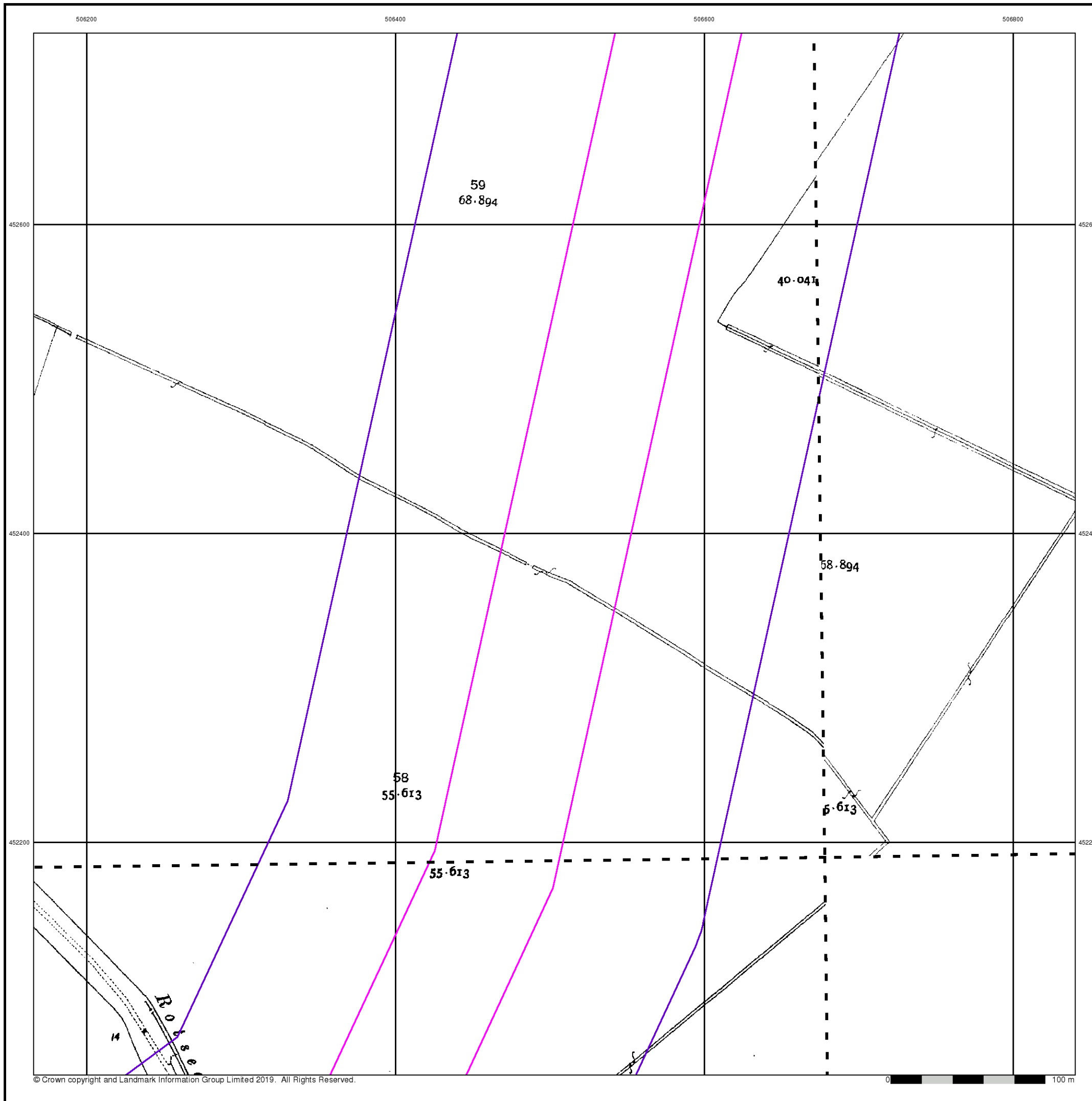

Ordnance Survey Plan

Published 1975

Source map scale - 1:2,500

The historical maps shown were reproduced from maps predominantly held at the scale adopted for England, Wales and Scotland in the 1840's. In 1854 the 1:2,500 scale was adopted for mapping urban areas and by 1896 it covered the whole of what were considered to be the cultivated parts of Great Britain. The published date given below is often some years later than the surveyed date. Before 1938, all OS maps were based on the Cassini Projection, with independent surveys of a single county or group of counties, giving rise to significant inaccuracies in outlying areas.

Map Name(s) and Date(s)

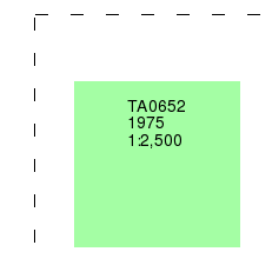

Historical Map - Segment C3

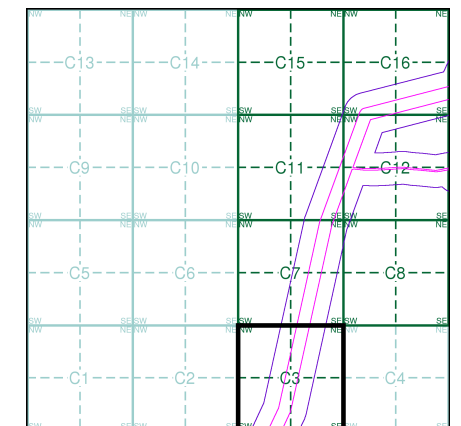

Order Details

Order Number: 201127465_1_1
 Customer Ref: PB8783-103-105
 National Grid Reference: 506560, 453280
 Slice: C
 Site Area (Ha): 72.
 Search Buffer (m): 100

Site Details

Hornsea Route

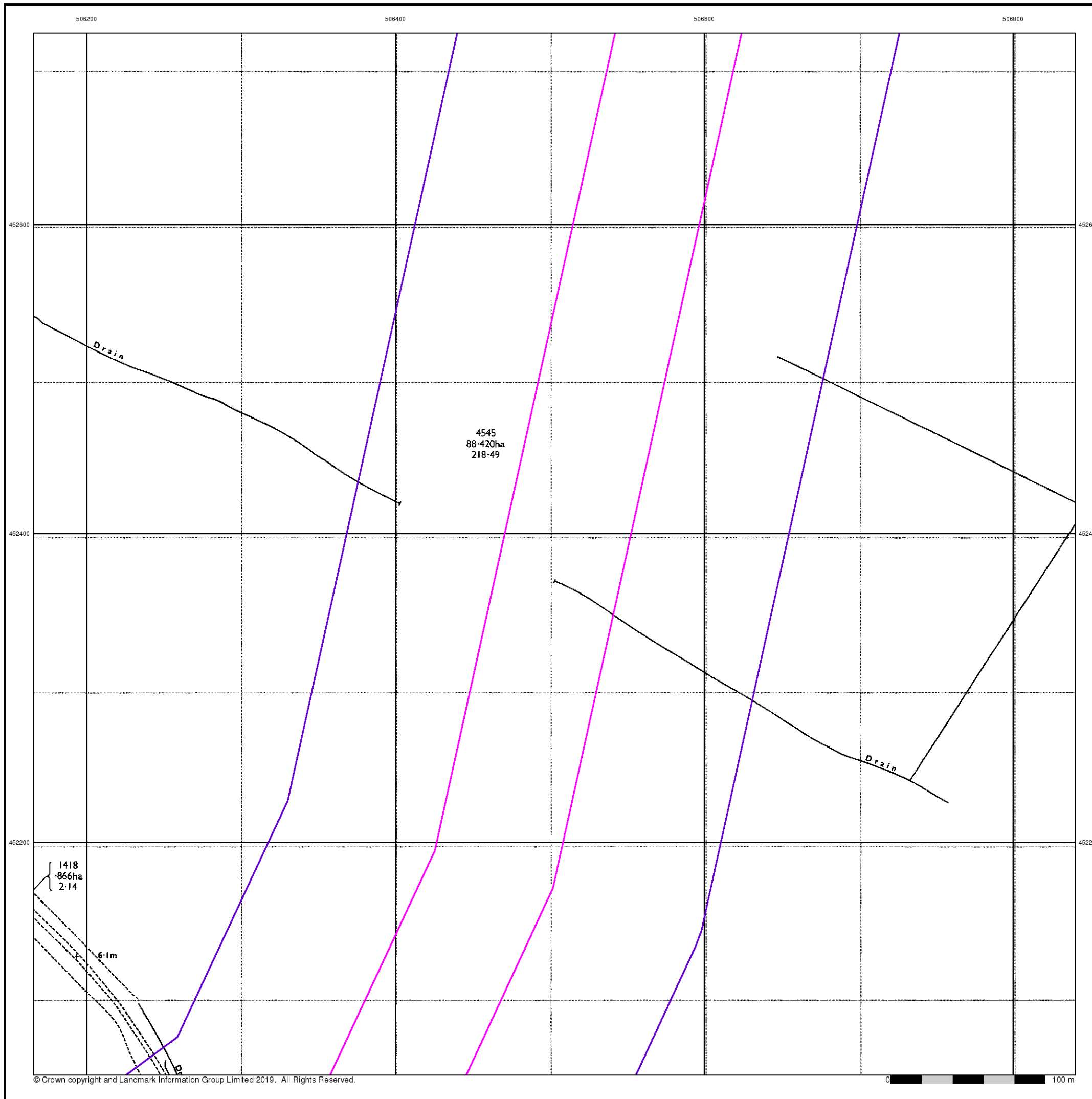

Large-Scale National Grid Data

Published 1995

Source map scale - 1:2,500

'Large Scale National Grid Data' superseded SIM cards (Ordnance Survey's 'Survey of Information on Microfilm') in 1992, and continued to be produced until 1999. These maps were the fore-runners of digital mapping and so provide detailed information on houses and roads, but tend to show less topographic features such as vegetation. These maps were produced at both 1:2,500 and 1:1,250 scales.

Map Name(s) and Date(s)

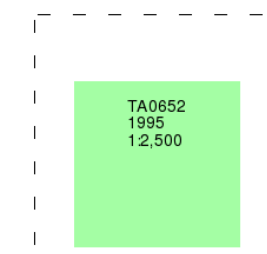

Historical Map - Segment C3

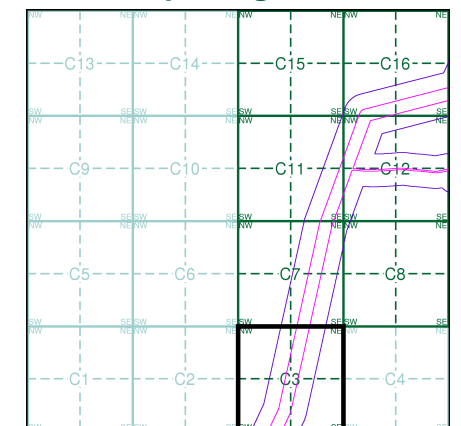

Order Details

Order Number: 201127465_1_1
Customer Ref: PB8783-103-105
National Grid Reference: 506560, 453280
Slice: C
Site Area (Ha): 72.
Search Buffer (m): 100

Site Details

Hornsea Route

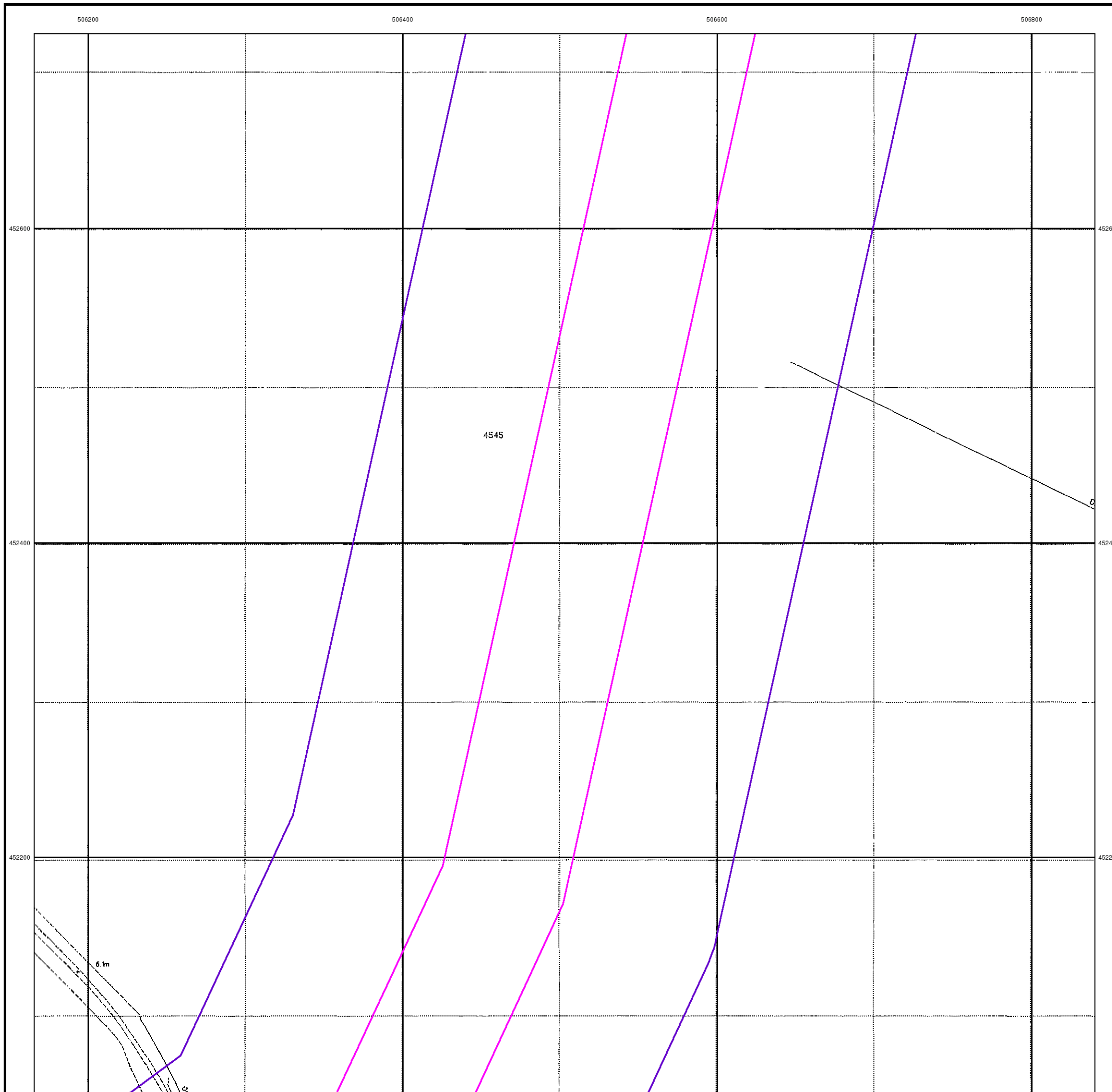

Historical Mapping Legends

Ordnance Survey County Series and Ordnance Survey Plan 1:2,500

Quarry **Gravel Pit** **Sand Pit**
Clay Pit **Shingle** **Refuse Heap**
Sloping Masonry **Flat Rock**
Marsh **Reeds** **Osiers**
Rough Pasture **Furze** **Wood**
Mixed Wood **Brushwood** **Orchard**
Fir **Ford** **Stepping Stones**
Ferry **Waterfall** **Lock**
Trig. Station **Altitude at Trig. Station**
B.M. 325.9 **Bench Mark** **Surface Level**
Arrow denotes flow of water **Antiquities (site of)**
Cutting **Embankment**
Railway crossing Road **Level Crossing** **Road crossing Railway**
Railway crossing River or Canal **Road over single stream** **Road over River or Canal**
County Boundary (Geographical)
County & Civil Parish Boundary
Administrative County & Civil Parish Boundary
County Borough Boundary (England)
Co. Boro. Bdy.
County Burgh Boundary (Scotland)
Boundary Post or Stone **Police Call Box**
B.R. **Bridle Road** **P** **Pump**
E.P. **Electricity Pylon** **S.P.** **Signal Post**
F.B. **Foot Bridge** **Sl.** **Sluice**
F.P. **Foot Path** **Sp.** **Spring**
G.P. **Guide Post or Board** **T.C.B.** **Telephone Call Box**
M.S. **Mile Stone** **Tr.** **Trough**
M.P. M.R. **Mooring Post or Ring** **W** **Well**

Ordnance Survey Plan, Additional SIMs and Supply of Unpublished Survey Information 1:2,500 and 1:1,250

Inactive Quarry, Chalk Pit or Clay Pit **Active Quarry, Chalk Pit or Clay Pit**
Rock **Boulders**
Cliff **Slopes** **Top**
Roofed Building **Glazed Roof Building**
Sloping Masonry **Archway**
Non-Coniferous Tree (surveyed) **Coniferous Tree (surveyed)**
Non-Coniferous Trees (not surveyed) **Coniferous Trees (not surveyed)**
Orchard Tree **Scrub** **Bracken**
Coppice, Osier **Reeds** **Marsh, Saltings**
Rough Grassland **Heath** **Culvert**
Direction of water flow **Bench Mark** **Antiquity (site of)**
Cave Entrance **Triangulation Station** **Electricity Pylon**
Electricity Transmission Line
County Boundary (Geographical)
County & Civil Parish Boundary
Civil Parish Boundary
Admin. County or County Bor. Boundary
London Borough Boundary
Symbol marking point where boundary mereing changes
BH **Beer House** **P** **Pillar, Pole or Post**
BP, BS **Boundary Post or Stone** **PO** **Post Office**
Cn, C **Capstan, Crane** **PC** **Public Convenience**
Chy **Chimney** **PH** **Public House**
D Fn **Drinking Fountain** **Pp** **Pump**
EI P **Electricity Pillar or Post** **SB, S Br** **Signal Box or Bridge**
FAP **Fire Alarm Pillar** **SP, SL** **Signal Post or Light**
FB **Foot Bridge** **Spr** **Spring**
GP **Guide Post** **Tk** **Tank or Track**
H **Hydrant or Hydraulic** **TCB** **Telephone Call Box**
LC **Level Crossing** **TCP** **Telephone Call Post**
MH **Manhole** **Tr** **Trough**
MP **Mile Post or Mooring Post** **Wr Pt, Wr T** **Water Point, Water Tap**
MS **Mile Stone** **W** **Well**
NTL **Normal Tidal Limit** **Wd Pp** **Wind Pump**

Large-Scale National Grid Data 1:2,500 and 1:1,250

Cliff **Slopes** **Top**
Rock **Rock (scattered)**
Boulders **Boulders (scattered)**
Positioned Boulder **Scree**
Non-Coniferous Tree (surveyed) **Coniferous Tree (surveyed)**
Non-Coniferous Trees (not surveyed) **Coniferous Trees (not surveyed)**
Orchard Tree **Scrub** **Bracken**
Coppice, Osier **Reeds** **Marsh, Saltings**
Rough Grassland **Heath** **Culvert**
Direction of water flow **Triangulation Station** **Antiquity (site of)**
Electricity Transmission Line **Electricity Pylon**
B.M. 231.60m **Bench Mark** **Buildings with Building Seed**
Roofed Building **Glazed Roof Building**
Civil parish/community boundary
District boundary
County boundary
Boundary post/stone
Boundary mereing symbol (note: these always appear in opposed pairs or groups of three)
Bks **Barracks** **P** **Pillar, Pole or Post**
Bty **Battery** **PO** **Post Office**
Cemy **Cemetery** **PC** **Public Convenience**
Chy **Chimney** **Pp** **Pump**
Cis **Cistern** **Ppg Sta** **Pumping Station**
Dismtd Rly **Dismantled Railway** **PW** **Place of Worship**
EI Gen Sta **Electricity Generating Station** **Sewage Ppg Sta** **Sewage Pumping Station**
EI P **Electricity Pole, Pillar** **SB, S Br** **Signal Box or Bridge**
EI Sub Sta **Electricity Sub Station** **SP, SL** **Signal Post or Light**
FB **Filter Bed** **Spr** **Spring**
Fn / D Fn **Fountain / Drinking Ftn.** **Tk** **Tank or Track**
Gas Gov **Gas Valve Compound** **Tr** **Trough**
GVC **Gas Governor** **Wd Pp** **Wind Pump**
GP **Guide Post** **Wr Pt, Wr T** **Water Point, Water Tap**
MH **Manhole** **Wks** **Works (building or area)**
MP, MS **Mile Post or Mile Stone** **W** **Well**

Envirocheck®

LANDMARK INFORMATION GROUP®

Historical Mapping & Photography included:

Mapping Type	Scale	Date	Pg
Yorkshire	1:2,500	1891	2
Yorkshire	1:2,500	1910	3
Ordnance Survey Plan	1:2,500	1977 - 1978	4
Large-Scale National Grid Data	1:2,500	1994	5

Historical Map - Segment C4

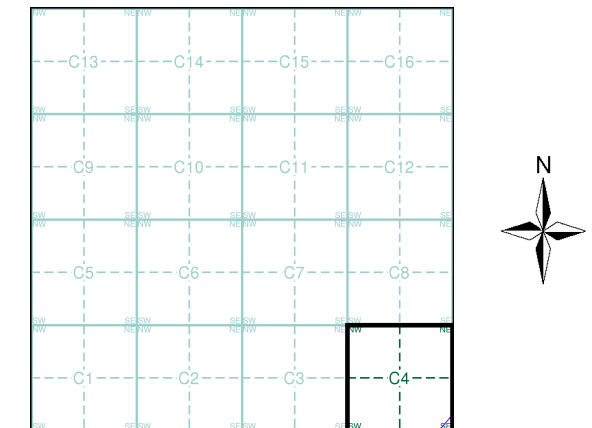

Order Details

Order Number: 201127555_1_1
 Customer Ref: PB8783-103-105
 National Grid Reference: 501460, 447610
 Slice: C
 Site Area (Ha): 62.79
 Search Buffer (m): 100

Site Details

Hornsea Route

Landmark
 INFORMATION GROUP

Tel: 0844 844 9952
 Fax: 0844 844 9951
 Web: www.envirocheck.co.uk

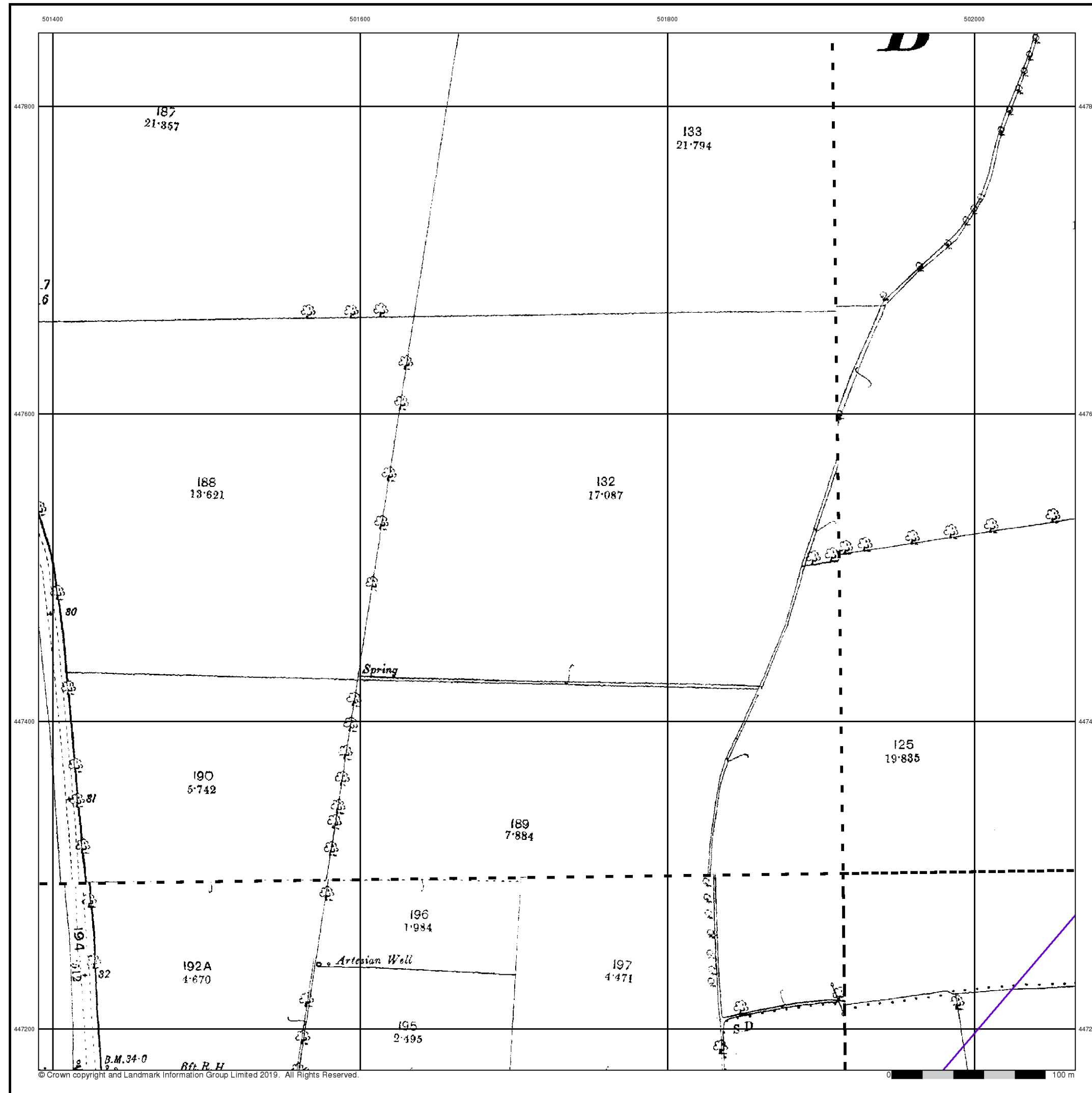

The historical maps shown were reproduced from maps predominantly held at the scale adopted for England, Wales and Scotland in the 1840's. In 1854 the 1:2,500 scale was adopted for mapping urban areas and by 1896 it covered the whole of what were considered to be the cultivated parts of Great Britain. The published date given below is often some years later than the surveyed date. Before 1938, all OS maps were based on the Cassini Projection, with independent surveys of a single county or group of counties, giving rise to significant inaccuracies in outlying areas.

Map Name(s) and Date(s)

195_03 1891 1:2,500	195_04 1891 1:2,500
195_07 1891 1:2,500	195_08 1891 1:2,500

Historical Map - Segment C4

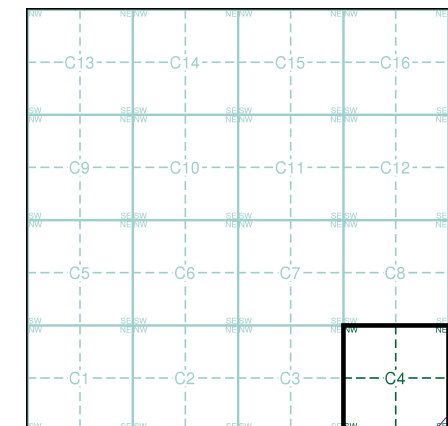

Order Details

Order Number: 201127555_1_1
 Customer Ref: PB8783-103-105
 National Grid Reference: 501460, 447610
 Slice: C
 Site Area (Ha): 62.79
 Search Buffer (m): 100

Site Details

Hornsea Route

The historical maps shown were reproduced from maps predominantly held at the scale adopted for England, Wales and Scotland in the 1840's. In 1854 the 1:2,500 scale was adopted for mapping urban areas and by 1896 it covered the whole of what were considered to be the cultivated parts of Great Britain. The published date given below is often some years later than the surveyed date. Before 1938, all OS maps were based on the Cassini Projection, with independent surveys of a single county or group of counties, giving rise to significant inaccuracies in outlying areas.

Map Name(s) and Date(s)

195_03 1910 1:2,500	195_04 1910 1:2,500
195_07 1910 1:2,500	195_08 1910 1:2,500

Historical Map - Segment C4

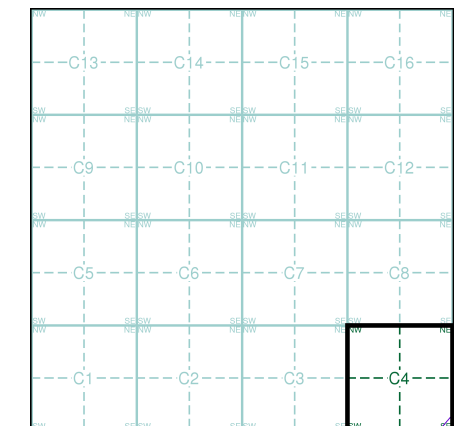

Order Details

Order Number: 201127555_1_1
 Customer Ref: PB8783-103-105
 National Grid Reference: 501460, 447610
 Slice: C
 Site Area (Ha): 62.79
 Search Buffer (m): 100

Site Details

Hornsea Route

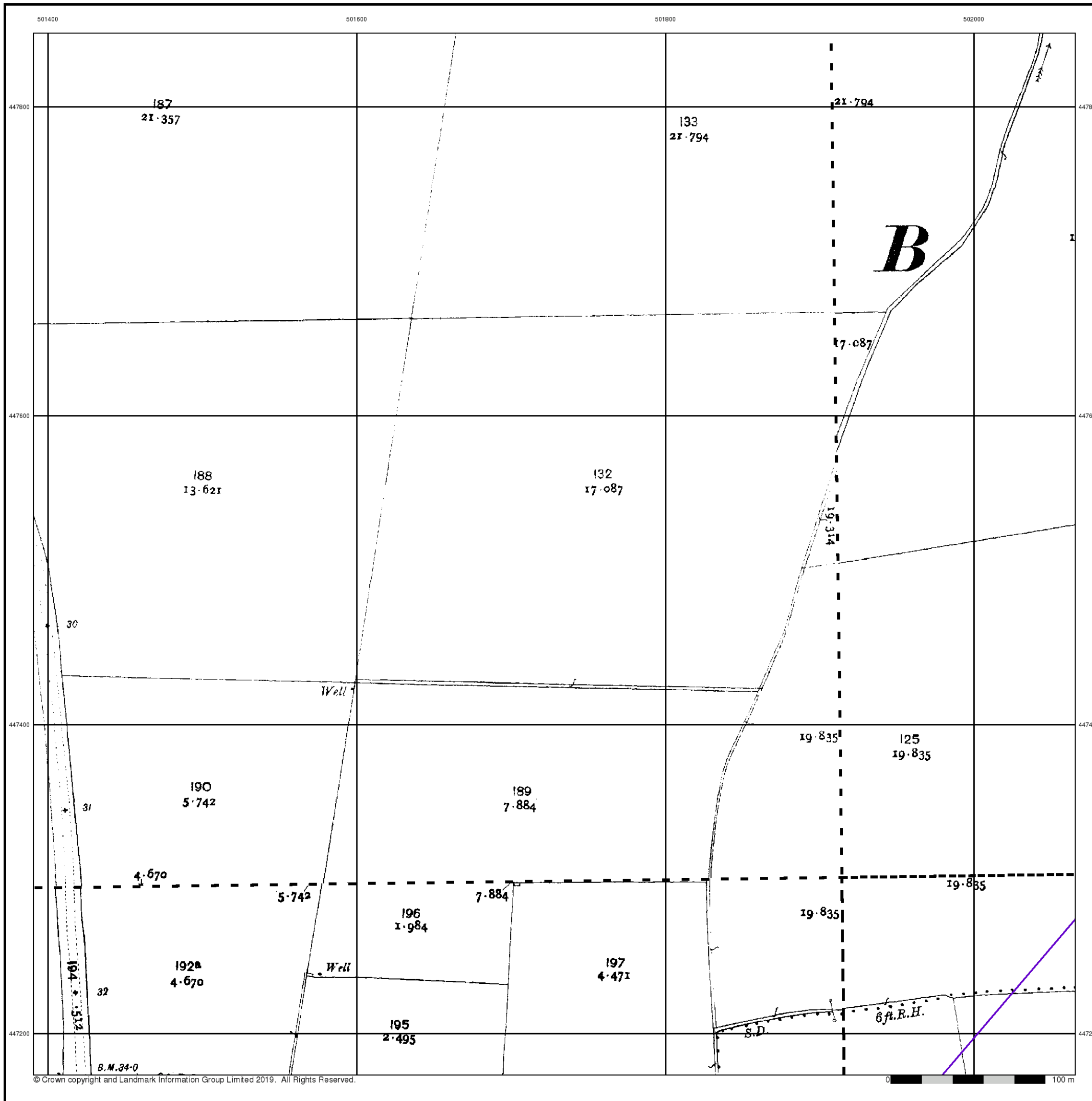

Ordnance Survey Plan

Published 1977 - 1978

Source map scale - 1:2,500

The historical maps shown were reproduced from maps predominantly held at the scale adopted for England, Wales and Scotland in the 1840's. In 1854 the 1:2,500 scale was adopted for mapping urban areas and by 1896 it covered the whole of what were considered to be the cultivated parts of Great Britain. The published date given below is often some years later than the surveyed date. Before 1938, all OS maps were based on the Cassini Projection, with independent surveys of a single county or group of counties, giving rise to significant inaccuracies in outlying areas.

Map Name(s) and Date(s)

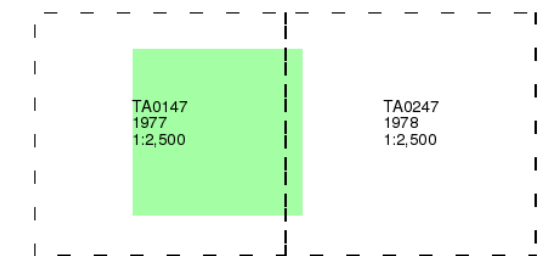

Historical Map - Segment C4

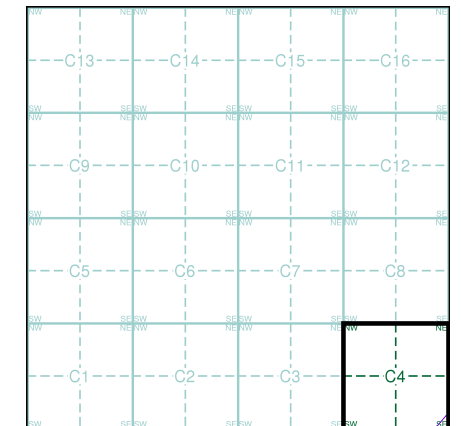

Order Details

Order Number: 201127555_1_1
 Customer Ref: PB8783-103-105
 National Grid Reference: 501460, 447610
 Slice: C
 Site Area (Ha): 62.79
 Search Buffer (m): 100

Site Details

Hornsea Route

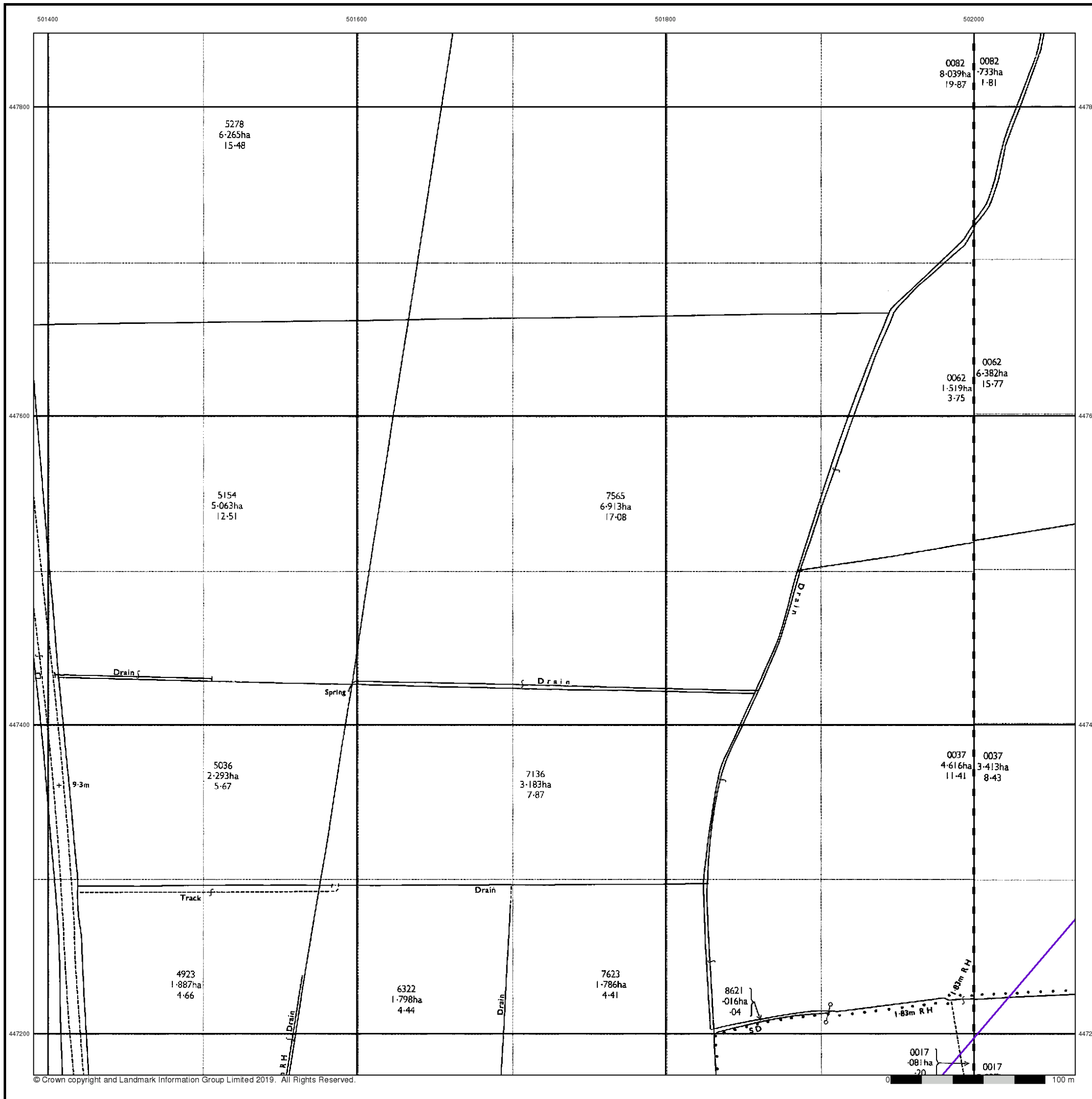

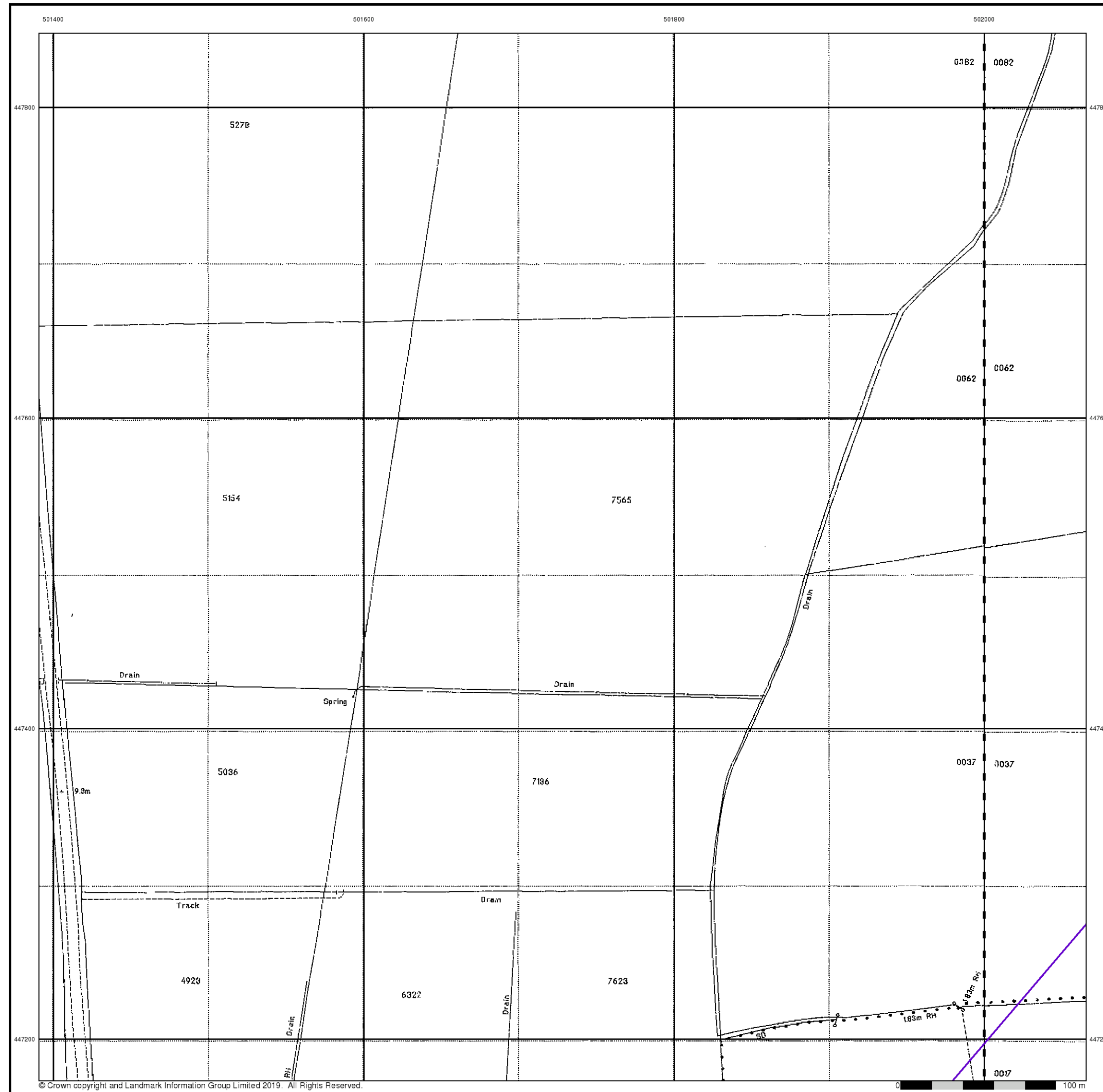

Large-Scale National Grid Data

Published 1994

Source map scale - 1:2,500

'Large Scale National Grid Data' superseded SIM cards (Ordnance Survey's 'Survey of Information on Microfilm') in 1992, and continued to be produced until 1999. These maps were the fore-runners of digital mapping and so provide detailed information on houses and roads, but tend to show less topographic features such as vegetation. These maps were produced at both 1:2,500 and 1:1,250 scales.

Map Name(s) and Date(s)

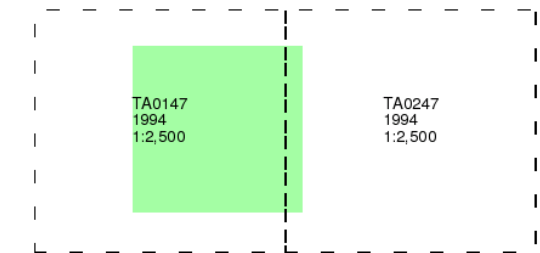

Historical Map - Segment C4

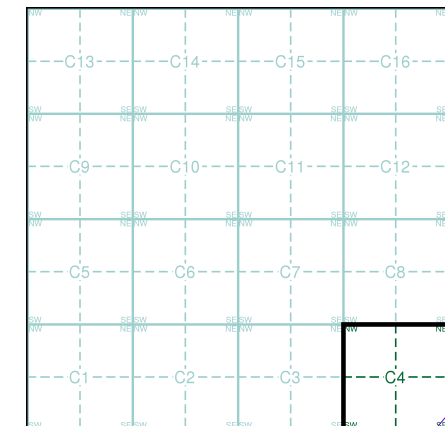

Order Details

Order Number: 201127555_1_1
 Customer Ref: PB8783-103-105
 National Grid Reference: 501460, 447610
 Slice: C
 Site Area (Ha): 62.79
 Search Buffer (m): 100

Site Details

Hornsea Route

Historical Mapping Legends

Ordnance Survey County Series and Ordnance Survey Plan 1:2,500

Quarry **Gravel Pit** **Sand Pit**
Clay Pit **Shingle** **Refuse Heap**
Sloping Masonry **Flat Rock**
Marsh **Reeds** **Osiers**
Rough Pasture **Furze** **Wood**
Mixed Wood **Brushwood** **Orchard**
Fir **Ford** **Stepping Stones**
Ferry **Waterfall** **Lock**
Trig. Station **Altitude at Trig. Station**
B.M. 325.9 **Bench Mark** **Surface Level**
Arrow denotes flow of water **Antiquities (site of)**
Cutting **Embankment**
Railway crossing Road **Level Crossing** **Road crossing Railway**
Railway crossing River or Canal **Road over single stream** **Road over River or Canal**
County Boundary (Geographical)
County & Civil Parish Boundary
Administrative County & Civil Parish Boundary
County Borough Boundary (England)
County Burgh Boundary (Scotland)
Co. Boro. Bdy.
Co. Burgh Bdy.
BP BS Boundary Post or Stone **P.C.B** Police Call Box
B.R. Bridle Road **P** Pump
E.P Electricity Pylon **S.P** Signal Post
F.B. Foot Bridge **SL** Sluice
F.P. Foot Path **Sp.** Spring
G.P Guide Post or Board **T.C.B** Telephone Call Box
M.S Mile Stone **Tr.** Trough
M.P M.R Mooring Post or Ring **W** Well

Ordnance Survey Plan, Additional SIMs and Supply of Unpublished Survey Information 1:2,500 and 1:1,250

Inactive Quarry, Chalk Pit or Clay Pit **Active Quarry, Chalk Pit or Clay Pit**
Rock **Boulders**
Cliff **Slopes** **Top**
Roofed Building **Glazed Roof Building**
Sloping Masonry **Archway**
Non-Coniferous Tree (surveyed) **Coniferous Tree (surveyed)**
Non-Coniferous Trees (not surveyed) **Coniferous Trees (not surveyed)**
Orchard Tree **Scrub** **Bracken**
Coppice, Osier **Reeds** **Marsh, Saltings**
Rough Grassland **Heath** **Culvert**
Direction of water flow **Bench Mark** **Antiquity (site of)**
Cave Entrance **Triangulation Station** **Electricity Pylon**
Electricity Transmission Line
County Boundary (Geographical)
County & Civil Parish Boundary
Civil Parish Boundary
Admin. County or County Bor. Boundary
London Borough Boundary
Symbol marking point where boundary mereing changes
BH Beer House **P** Pillar, Pole or Post
BP, BS Boundary Post or Stone **PO** Post Office
Cn, C Capstan, Crane **PC** Public Convenience
Chy Chimney **PH** Public House
D Fn Drinking Fountain **Pp** Pump
EI P Electricity Pillar or Post **SB, S Br** Signal Box or Bridge
FAP Fire Alarm Pillar **SP, SL** Signal Post or Light
FB Foot Bridge **Spr** Spring
GP Guide Post **Tk** Tank or Track
H Hydrant or Hydraulic **TCB** Telephone Call Box
LC Level Crossing **TCP** Telephone Call Post
MH Manhole **Tr** Trough
MP Mile Post or Mooring Post **Wr Pt, Wr T** Water Point, Water Tap
MS Mile Stone **W** Well
NTL Normal Tidal Limit **Wd Pp** Wind Pump

Large-Scale National Grid Data 1:2,500 and 1:1,250

Cliff **Slopes** **Top**
Rock **Rock (scattered)**
Boulders **Boulders (scattered)**
Positioned Boulder **Scree**
Non-Coniferous Tree (surveyed) **Coniferous Tree (surveyed)**
Non-Coniferous Trees (not surveyed) **Coniferous Trees (not surveyed)**
Orchard Tree **Scrub** **Bracken**
Coppice, Osier **Reeds** **Marsh, Saltings**
Rough Grassland **Heath** **Culvert**
Direction of water flow **Triangulation Station** **Antiquity (site of)**
Electricity Transmission Line **Electricity Pylon**
B.M. 231.60m Bench Mark **Buildings with Building Seed**
Roofed Building **Glazed Roof Building**
Civil parish/community boundary
District boundary
County boundary
Boundary post/stone
Boundary mereing symbol (note: these always appear in opposed pairs or groups of three)
Bks Barracks **P** Pillar, Pole or Post
Bty Battery **PO** Post Office
Cemy Cemetery **PC** Public Convenience
Chy Chimney **Pp** Pump
Cis Cistern **Ppg Sta** Pumping Station
Dismtd Rly Dismantled Railway **PW** Place of Worship
EI Gen Sta Electricity Generating Station **Sewage Ppg Sta** Sewage Pumping Station
EI P Electricity Pole, Pillar **SB, S Br** Signal Box or Bridge
EI Sub Sta Electricity Sub Station **SP, SL** Signal Post or Light
FB Filter Bed **Spr** Spring
Fn / D Fn Fountain / Drinking Ftn. **Tk** Tank or Track
Gas Gov Gas Valve Compound **Tr** Trough
GVC Gas Governor **Wd Pp** Wind Pump
GP Guide Post **Wr Pt, Wr T** Water Point, Water Tap
MH Manhole **Wks** Works (building or area)
MP, MS Mile Post or Mile Stone **W** Well

Envirocheck®

LANDMARK INFORMATION GROUP®

Historical Mapping & Photography included:

Mapping Type	Scale	Date	Pg
Yorkshire	1:2,500	1892	2
Yorkshire	1:2,500	1910	3
Ordnance Survey Plan	1:2,500	1975 - 1976	4
Large-Scale National Grid Data	1:2,500	1995	5

Historical Map - Segment C7

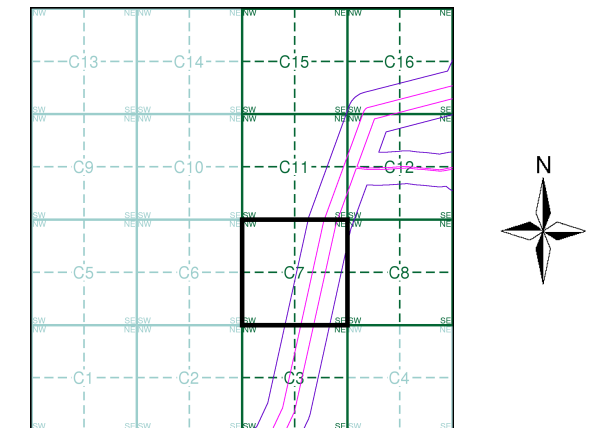

Order Details

Order Number: 201127465_1_1
 Customer Ref: PB8783-103-105
 National Grid Reference: 506560, 453280
 Slice: C
 Site Area (Ha): 72.
 Search Buffer (m): 100

Site Details

Hornsea Route

Landmark®
 LANDMARK INFORMATION GROUP

Tel: 0844 844 9952
 Fax: 0844 844 9951
 Web: www.envirocheck.co.uk

The historical maps shown were reproduced from maps predominantly held at the scale adopted for England, Wales and Scotland in the 1840's. In 1854 the 1:2,500 scale was adopted for mapping urban areas and by 1896 it covered the whole of what were considered to be the cultivated parts of Great Britain. The published date given below is often some years later than the surveyed date. Before 1938, all OS maps were based on the Cassini Projection, with independent surveys of a single county or group of counties, giving rise to significant inaccuracies in outlying areas.

Map Name(s) and Date(s)

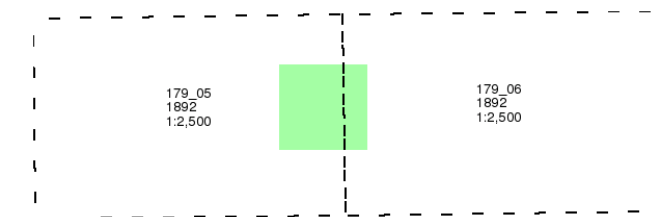

Historical Map - Segment C7

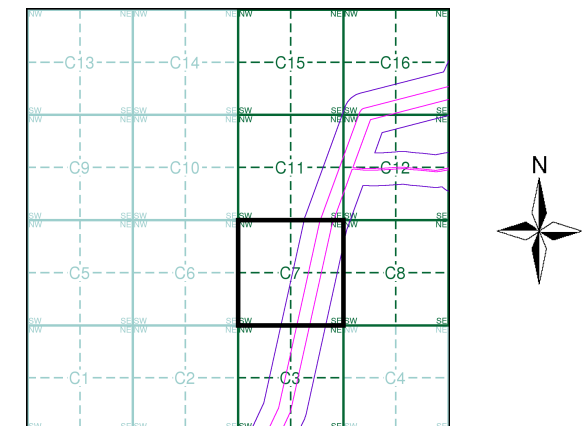

Order Details

Order Number: 201127465_1_1
 Customer Ref: PB8783-103-105
 National Grid Reference: 506560, 453280
 Slice: C
 Site Area (Ha): 72.
 Search Buffer (m): 100

Site Details

Hornsea Route

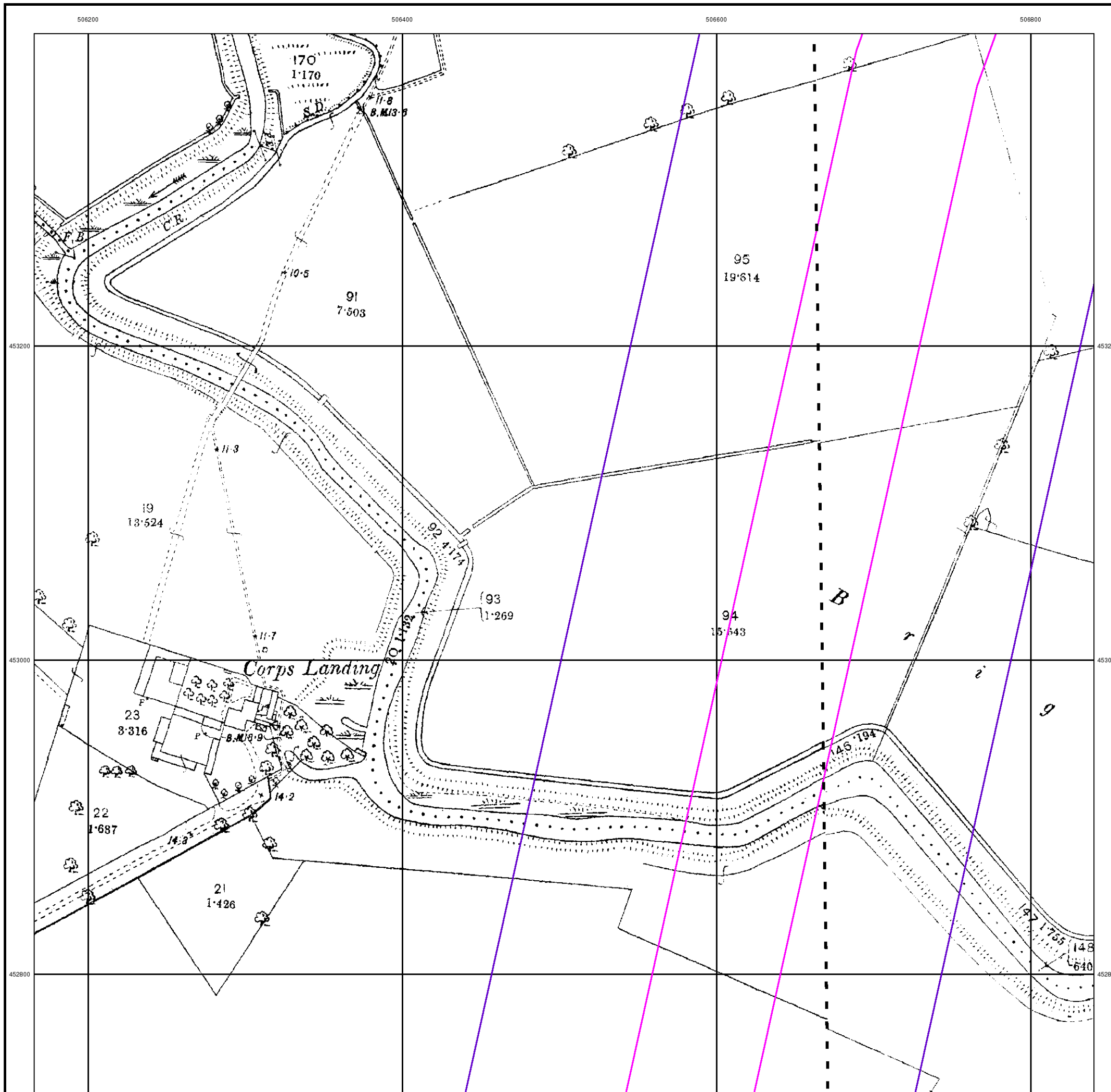

The historical maps shown were reproduced from maps predominantly held at the scale adopted for England, Wales and Scotland in the 1840's. In 1854 the 1:2,500 scale was adopted for mapping urban areas and by 1896 it covered the whole of what were considered to be the cultivated parts of Great Britain. The published date given below is often some years later than the surveyed date. Before 1938, all OS maps were based on the Cassini Projection, with independent surveys of a single county or group of counties, giving rise to significant inaccuracies in outlying areas.

Map Name(s) and Date(s)

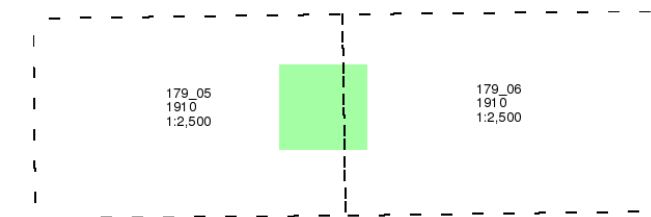

Historical Map - Segment C7

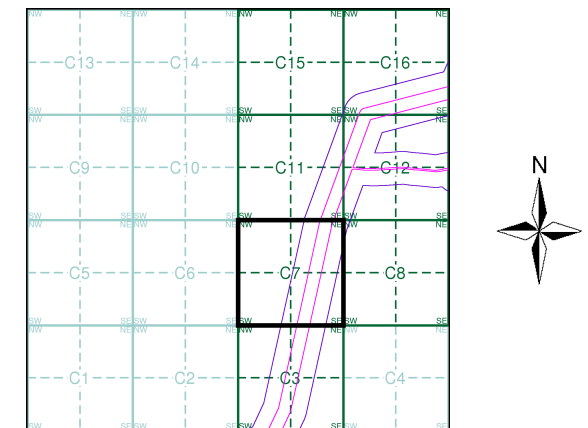

Order Details

Order Number: 201127465_1_1
 Customer Ref: PB8783-103-105
 National Grid Reference: 506560, 453280
 Slice: C
 Site Area (Ha): 72.
 Search Buffer (m): 100

Site Details

Hornsea Route

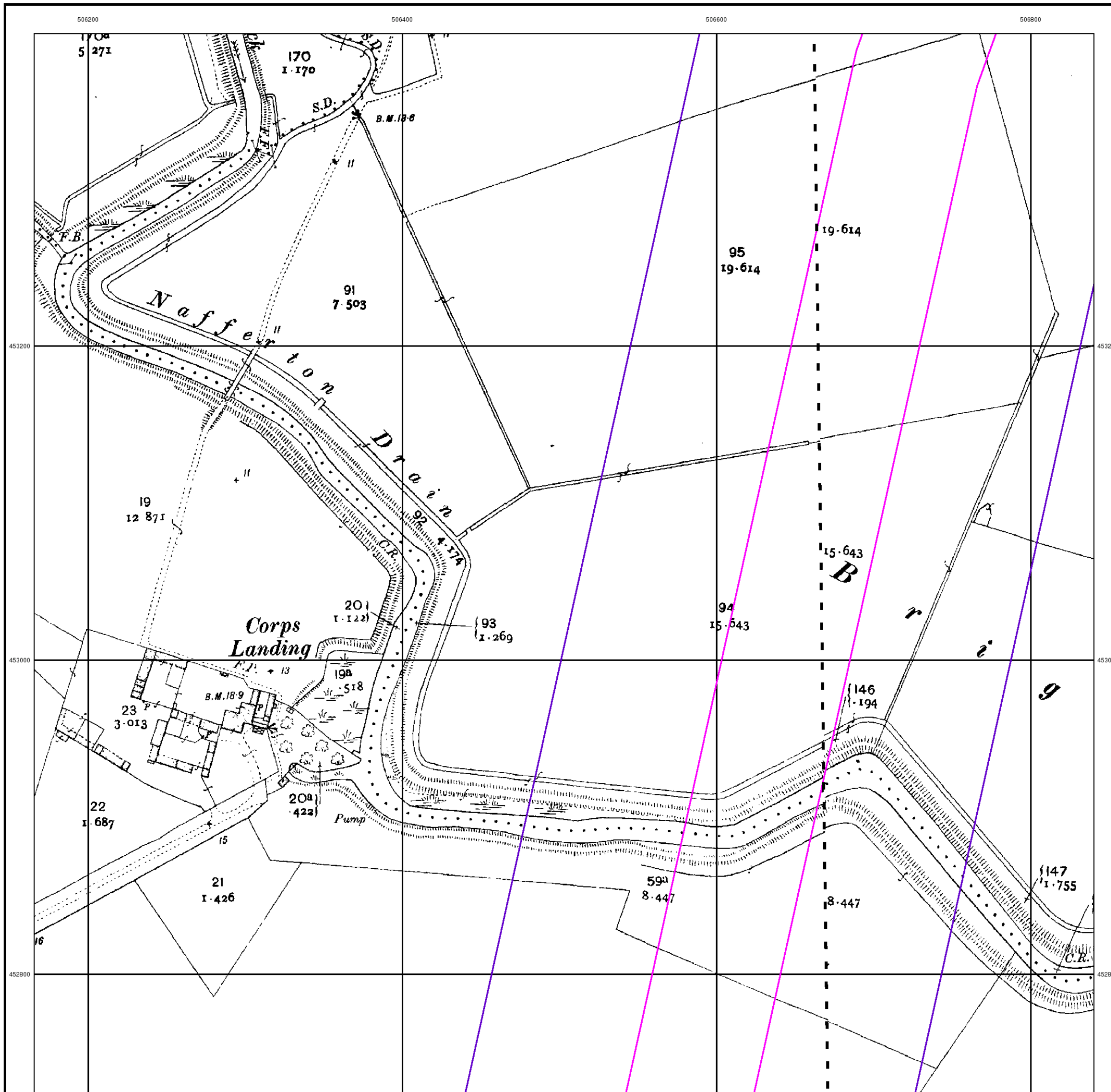

Ordnance Survey Plan

Published 1975 - 1976

Source map scale - 1:2,500

The historical maps shown were reproduced from maps predominantly held at the scale adopted for England, Wales and Scotland in the 1840's. In 1854 the 1:2,500 scale was adopted for mapping urban areas and by 1896 it covered the whole of what were considered to be the cultivated parts of Great Britain. The published date given below is often some years later than the surveyed date. Before 1938, all OS maps were based on the Cassini Projection, with independent surveys of a single county or group of counties, giving rise to significant inaccuracies in outlying areas.

Map Name(s) and Date(s)

TA0653	1976	1:2,500
TA0652	1975	1:2,500

Historical Map - Segment C7

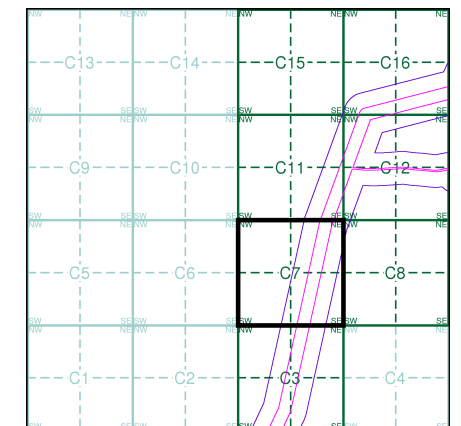

Order Details

Order Number: 201127465_1_1
 Customer Ref: PB8783-103-105
 National Grid Reference: 506560, 453280
 Slice: C
 Site Area (Ha): 72.
 Search Buffer (m): 100

Site Details

Hornsea Route

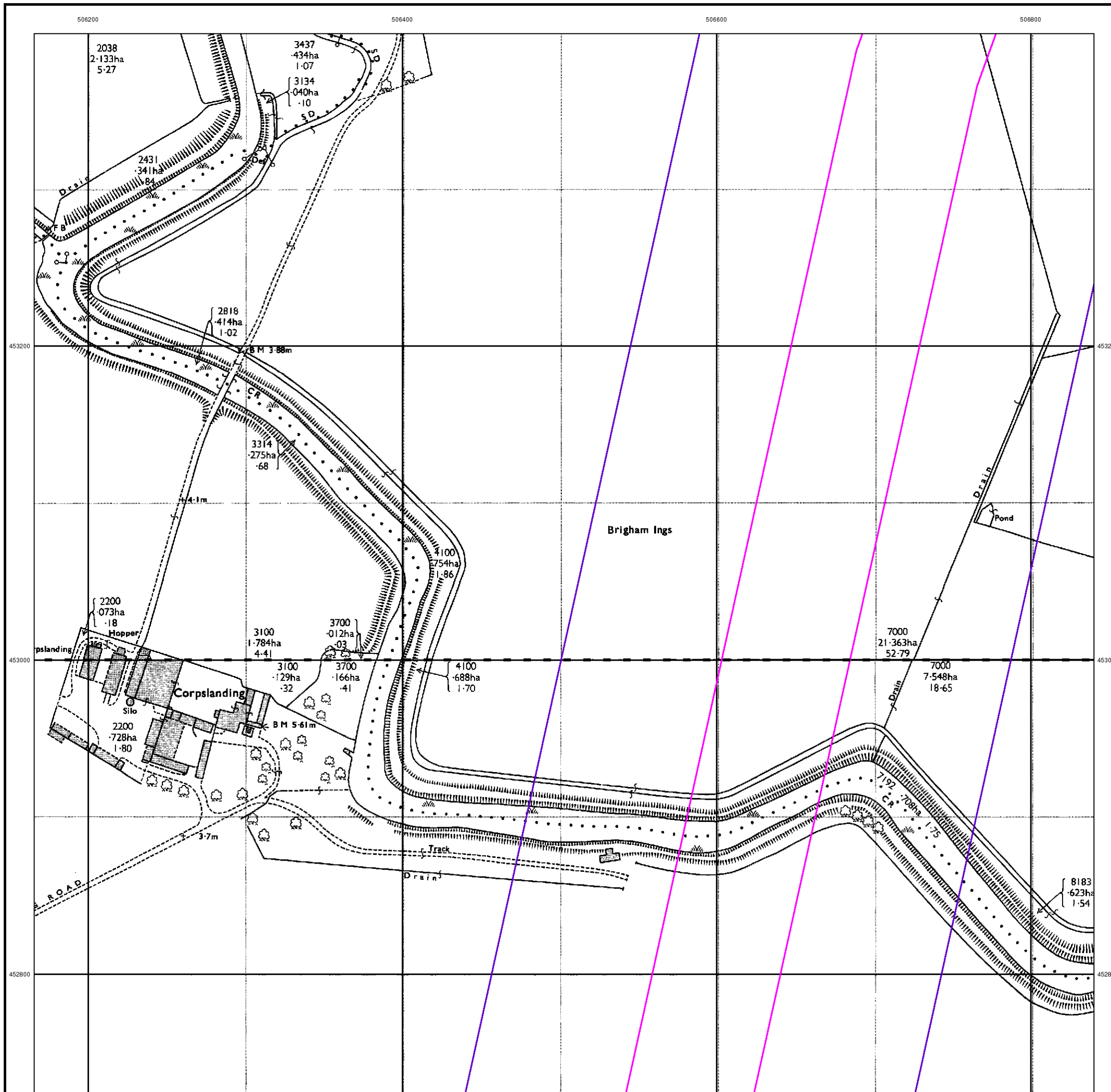

Large-Scale National Grid Data

Published 1995

Source map scale - 1:2,500

'Large Scale National Grid Data' superseded SIM cards (Ordnance Survey's 'Survey of Information on Microfilm') in 1992, and continued to be produced until 1999. These maps were the fore-runners of digital mapping and so provide detailed information on houses and roads, but tend to show less topographic features such as vegetation. These maps were produced at both 1:2,500 and 1:1,250 scales.

Map Name(s) and Date(s)

TA0653	1995	1:2,500
TA0652	1995	1:2,500

Historical Map - Segment C7

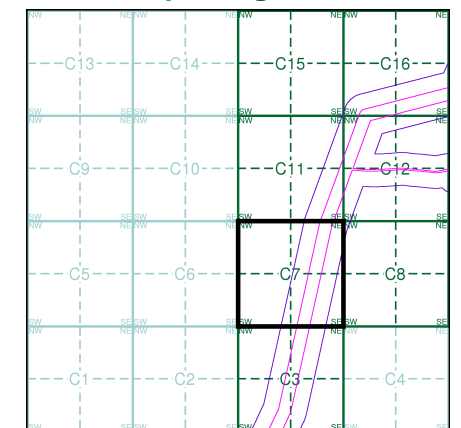

Order Details

Order Number: 201127465_1_1
 Customer Ref: PB8783-103-105
 National Grid Reference: 506560, 453280
 Slice: C
 Site Area (Ha): 72.
 Search Buffer (m): 100

Site Details

Hornsea Route

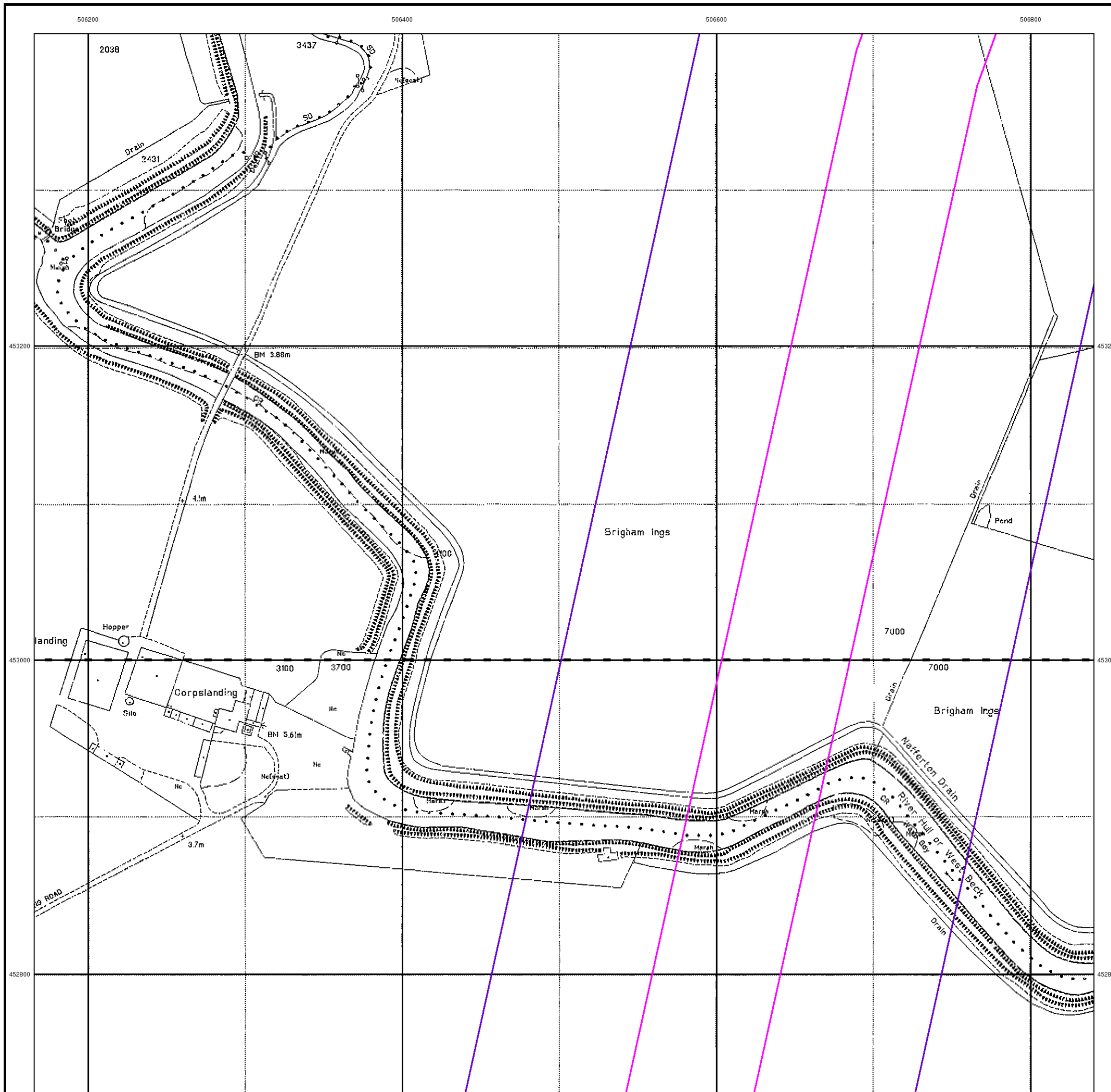

Historical Mapping Legends

Ordnance Survey County Series and Ordnance Survey Plan 1:2,500

Quarry **Gravel Pit** **Sand Pit**
Clay Pit **Shingle** **Refuse Heap**
Sloping Masonry **Flat Rock**
Marsh **Reeds** **Osiers**
Rough Pasture **Furze** **Wood**
Mixed Wood **Brushwood** **Orchard**
Fir **Ford** **Stepping Stones**
Ferry **Waterfall** **Lock**
Trig. Station **Altitude at Trig. Station**
B.M. 325.9 **Bench Mark** **Surface Level**
Arrow denotes flow of water **Antiquities (site of)**
Cutting **Embankment**
Railway crossing Road **Level Crossing** **Road crossing Railway**
Railway crossing River or Canal **Road over single stream** **Road over River or Canal**
County Boundary (Geographical)
County & Civil Parish Boundary
Administrative County & Civil Parish Boundary
County Borough Boundary (England)
County Burgh Boundary (Scotland)
Co. Boro. Bdy.
Co. Burgh Bdy.
BP BS Boundary Post or Stone **P.C.B** Police Call Box
B.R. Bridle Road **P** Pump
E.P Electricity Pylon **S.P** Signal Post
F.B. Foot Bridge **SL** Sluice
F.P. Foot Path **Sp.** Spring
G.P Guide Post or Board **T.C.B** Telephone Call Box
M.S Mile Stone **Tr.** Trough
M.P M.R Mooring Post or Ring **W** Well

Ordnance Survey Plan, Additional SIMs and Supply of Unpublished Survey Information 1:2,500 and 1:1,250

Inactive Quarry, Chalk Pit or Clay Pit **Active Quarry, Chalk Pit or Clay Pit**
Rock **Boulders**
Cliff **Slopes** **Top**
Roofed Building **Glazed Roof Building**
Sloping Masonry **Archway**
Non-Coniferous Tree (surveyed) **Coniferous Tree (surveyed)**
Non-Coniferous Trees (not surveyed) **Coniferous Trees (not surveyed)**
Orchard Tree **Scrub** **Bracken**
Coppice, Osier **Reeds** **Marsh, Saltings**
Rough Grassland **Heath** **Culvert**
Direction of water flow **Bench Mark** **Antiquity (site of)**
Cave Entrance **Triangulation Station** **Electricity Pylon**
Electricity Transmission Line
County Boundary (Geographical)
County & Civil Parish Boundary
Civil Parish Boundary
Admin. County or County Bor. Boundary
London Borough Boundary
Symbol marking point where boundary mereing changes
BH Beer House **P** Pillar, Pole or Post
BP, BS Boundary Post or Stone **PO** Post Office
Cn, C Capstan, Crane **PC** Public Convenience
Chy Chimney **PH** Public House
D Fn Drinking Fountain **Pp** Pump
EI P Electricity Pillar or Post **SB, S Br** Signal Box or Bridge
FAP Fire Alarm Pillar **SP, SL** Signal Post or Light
FB Foot Bridge **Spr** Spring
GP Guide Post **Tk** Tank or Track
H Hydrant or Hydraulic **TCB** Telephone Call Box
LC Level Crossing **TCP** Telephone Call Post
MH Manhole **Tr** Trough
MP Mile Post or Mooring Post **Wr Pt, Wr T** Water Point, Water Tap
MS Mile Stone **W** Well
NTL Normal Tidal Limit **Wd Pp** Wind Pump

Large-Scale National Grid Data 1:2,500 and 1:1,250

Cliff **Slopes** **Top**
Rock **Rock (scattered)**
Boulders **Boulders (scattered)**
Positioned Boulder **Scree**
Non-Coniferous Tree (surveyed) **Coniferous Tree (surveyed)**
Non-Coniferous Trees (not surveyed) **Coniferous Trees (not surveyed)**
Orchard Tree **Scrub** **Bracken**
Coppice, Osier **Reeds** **Marsh, Saltings**
Rough Grassland **Heath** **Culvert**
Direction of water flow **Triangulation Station** **Antiquity (site of)**
Electricity Transmission Line **Electricity Pylon**
B.M. 231.60m **Bench Mark** **Buildings with Building Seed**
Roofed Building **Glazed Roof Building**
Civil parish/community boundary
District boundary
County boundary
Boundary post/stone
Boundary mereing symbol (note: these always appear in opposed pairs or groups of three)
Bks Barracks **P** Pillar, Pole or Post
Bty Battery **PO** Post Office
Cemy Cemetery **PC** Public Convenience
Chy Chimney **Pp** Pump
Cis Cistern **Ppg Sta** Pumping Station
Dismtd Rly Dismantled Railway **PW** Place of Worship
EI Gen Sta Electricity Generating Station **Sewage Ppg Sta** Sewage Pumping Station
EI P Electricity Pole, Pillar **SB, S Br** Signal Box or Bridge
EI Sub Sta Electricity Sub Station **SP, SL** Signal Post or Light
FB Filter Bed **Spr** Spring
Fn / D Fn Fountain / Drinking Ftn. **Tk** Tank or Track
Gas Gov Gas Valve Compound **Tr** Trough
GVC Gas Governor **Wd Pp** Wind Pump
GP Guide Post **Wr Pt, Wr T** Water Point, Water Tap
MH Manhole **Wks** Works (building or area)
MP, MS Mile Post or Mile Stone **W** Well

Envirocheck

LANDMARK INFORMATION GROUP

Historical Mapping & Photography included:

Mapping Type	Scale	Date	Pg
Yorkshire	1:2,500	1892	2
Yorkshire	1:2,500	1910	3
Ordnance Survey Plan	1:2,500	1975 - 1976	4
Large-Scale National Grid Data	1:2,500	1995	5

Historical Map - Segment C8

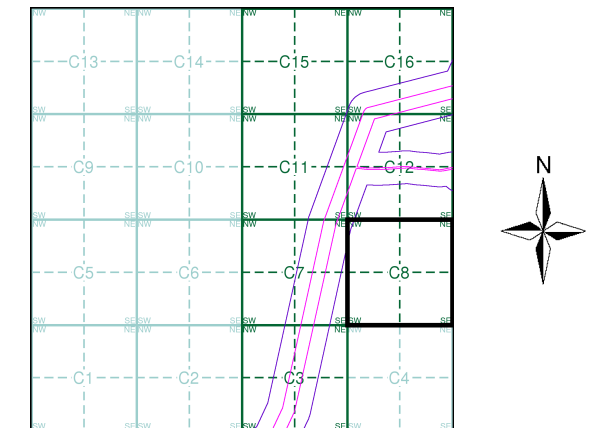

Order Details

Order Number: 201127465_1_1
 Customer Ref: PB8783-103-105
 National Grid Reference: 506560, 453280
 Slice: C
 Site Area (Ha): 72.
 Search Buffer (m): 100

Site Details

Hornsea Route

Landmark
 INFORMATION GROUP

Tel: 0844 844 9952
 Fax: 0844 844 9951
 Web: www.envirocheck.co.uk

The historical maps shown were reproduced from maps predominantly held at the scale adopted for England, Wales and Scotland in the 1840's. In 1854 the 1:2,500 scale was adopted for mapping urban areas and by 1896 it covered the whole of what were considered to be the cultivated parts of Great Britain. The published date given below is often some years later than the surveyed date. Before 1938, all OS maps were based on the Cassini Projection, with independent surveys of a single county or group of counties, giving rise to significant inaccuracies in outlying areas.

Map Name(s) and Date(s)

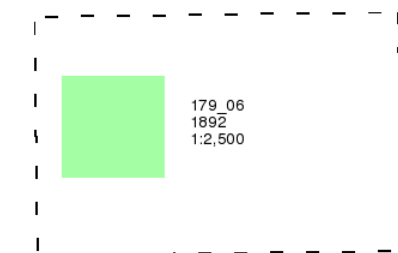

Historical Map - Segment C8

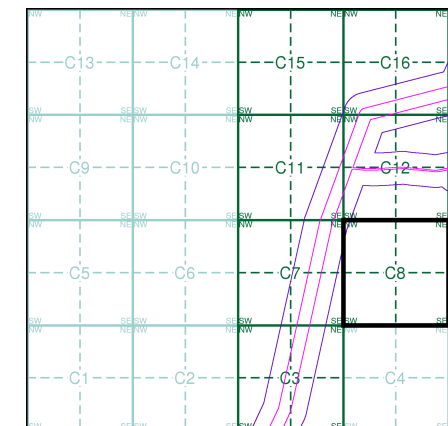

Order Details

Order Number: 201127465_1_1
 Customer Ref: PB8783-103-105
 National Grid Reference: 506560, 453280
 Slice: C
 Site Area (Ha): 72.
 Search Buffer (m): 100

Site Details

Hornsea Route

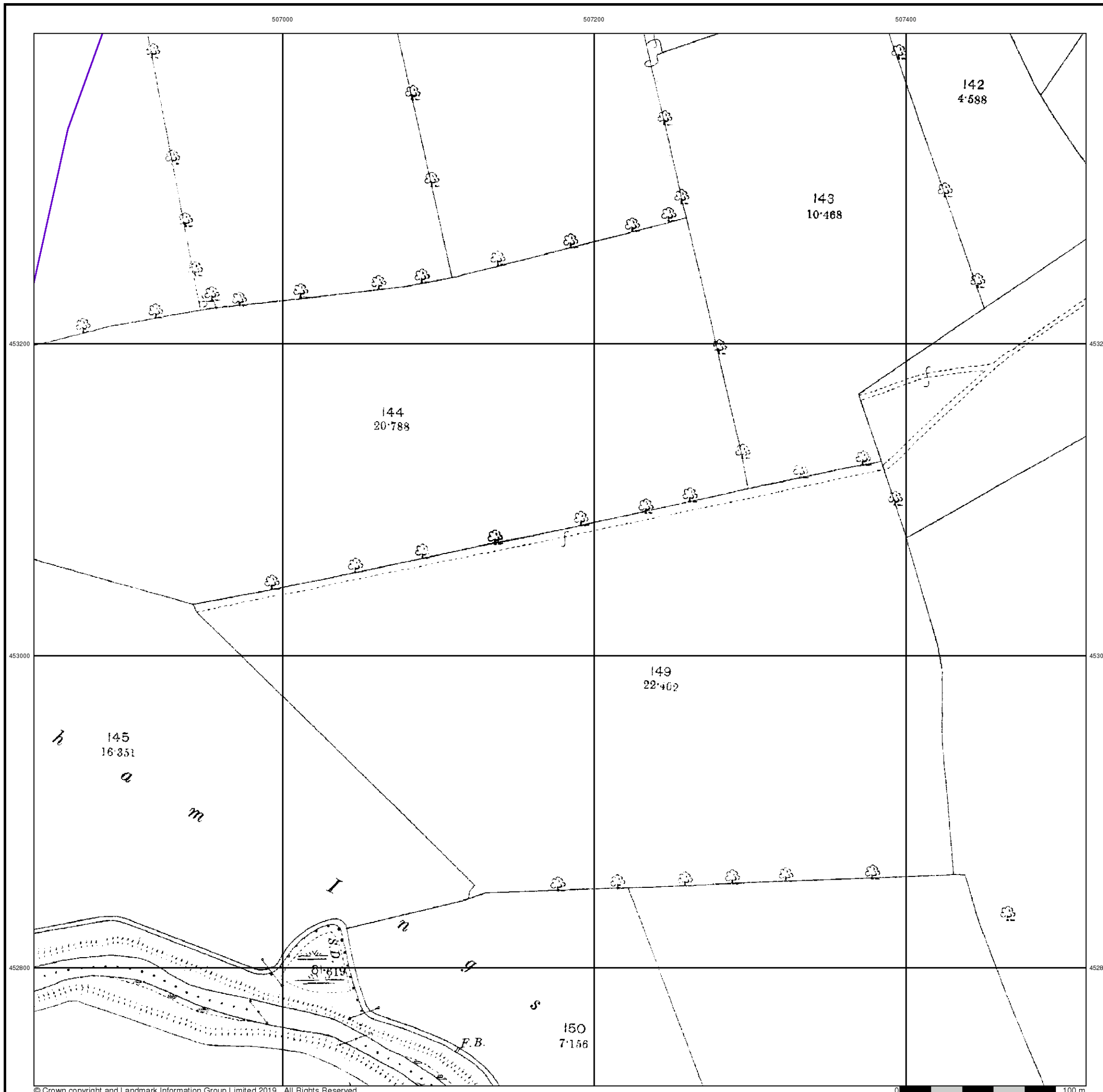

The historical maps shown were reproduced from maps predominantly held at the scale adopted for England, Wales and Scotland in the 1840's. In 1854 the 1:2,500 scale was adopted for mapping urban areas and by 1896 it covered the whole of what were considered to be the cultivated parts of Great Britain. The published date given below is often some years later than the surveyed date. Before 1938, all OS maps were based on the Cassini Projection, with independent surveys of a single county or group of counties, giving rise to significant inaccuracies in outlying areas.

Map Name(s) and Date(s)

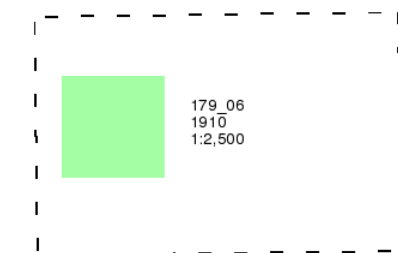

Historical Map - Segment C8

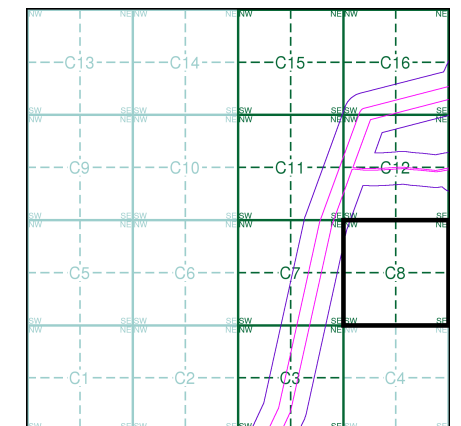

Order Details

Order Number: 201127465_1_1
 Customer Ref: PB8783-103-105
 National Grid Reference: 506560, 453280
 Slice: C
 Site Area (Ha): 72.
 Search Buffer (m): 100

Site Details

Hornsea Route

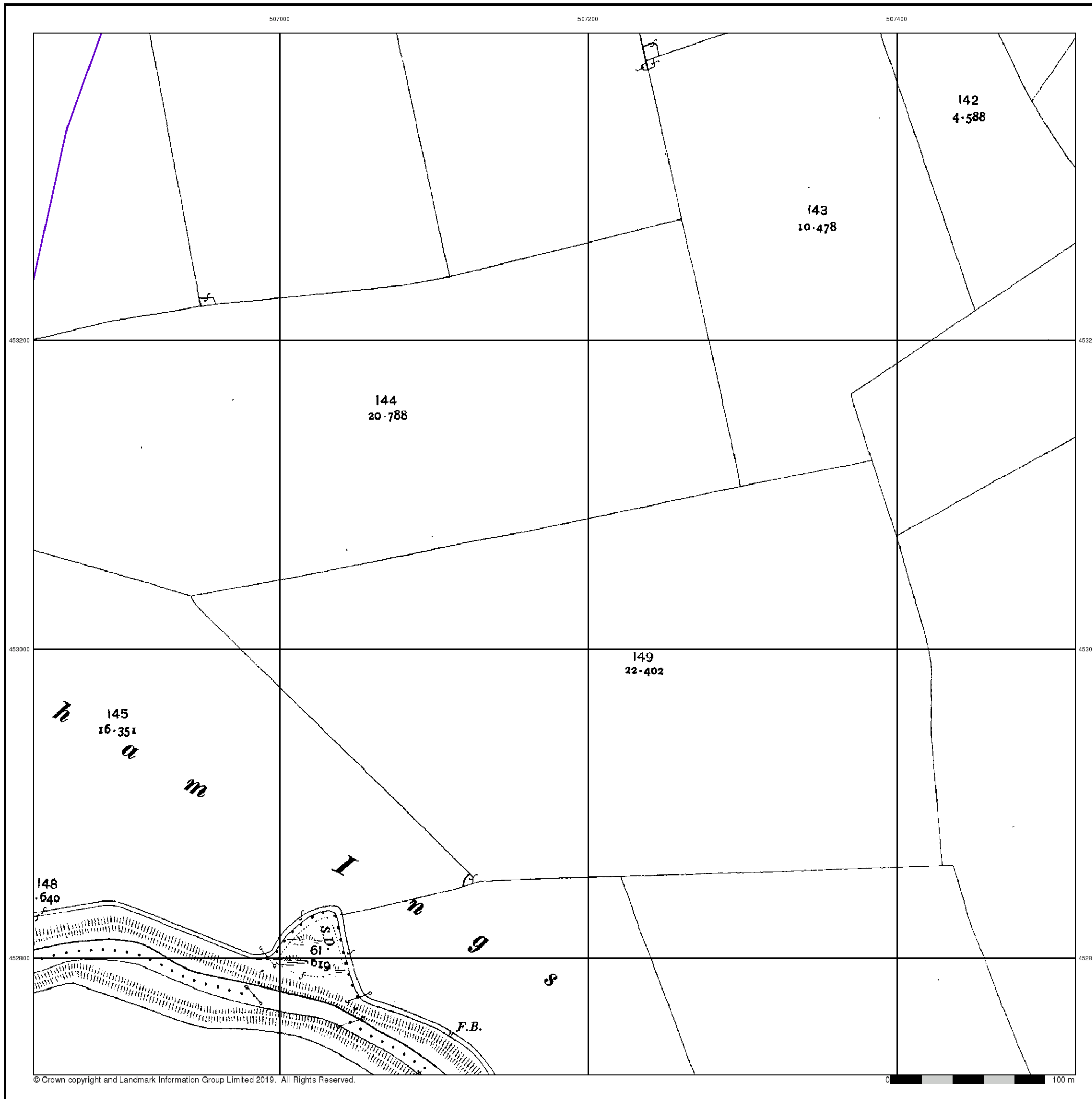

Ordnance Survey Plan

Published 1975 - 1976

Source map scale - 1:2,500

The historical maps shown were reproduced from maps predominantly held at the scale adopted for England, Wales and Scotland in the 1840's. In 1854 the 1:2,500 scale was adopted for mapping urban areas and by 1896 it covered the whole of what were considered to be the cultivated parts of Great Britain. The published date given below is often some years later than the surveyed date. Before 1938, all OS maps were based on the Cassini Projection, with independent surveys of a single county or group of counties, giving rise to significant inaccuracies in outlying areas.

Map Name(s) and Date(s)

TA0653 1976 12,500	TA0753 1976 12,500
TA0652 1975 12,500	TA0752 1975 12,500

Historical Map - Segment C8

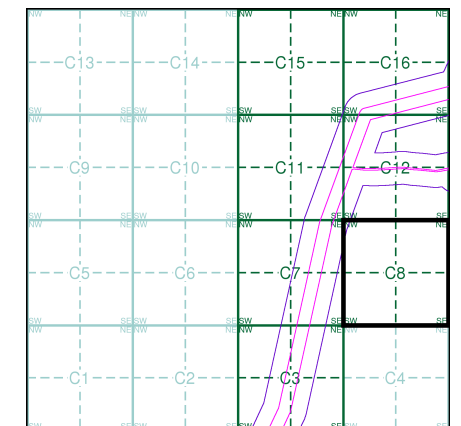

Order Details

Order Number: 201127465_1_1
 Customer Ref: PB8783-103-105
 National Grid Reference: 506560, 453280
 Slice: C
 Site Area (Ha): 72.
 Search Buffer (m): 100

Site Details

Hornsea Route

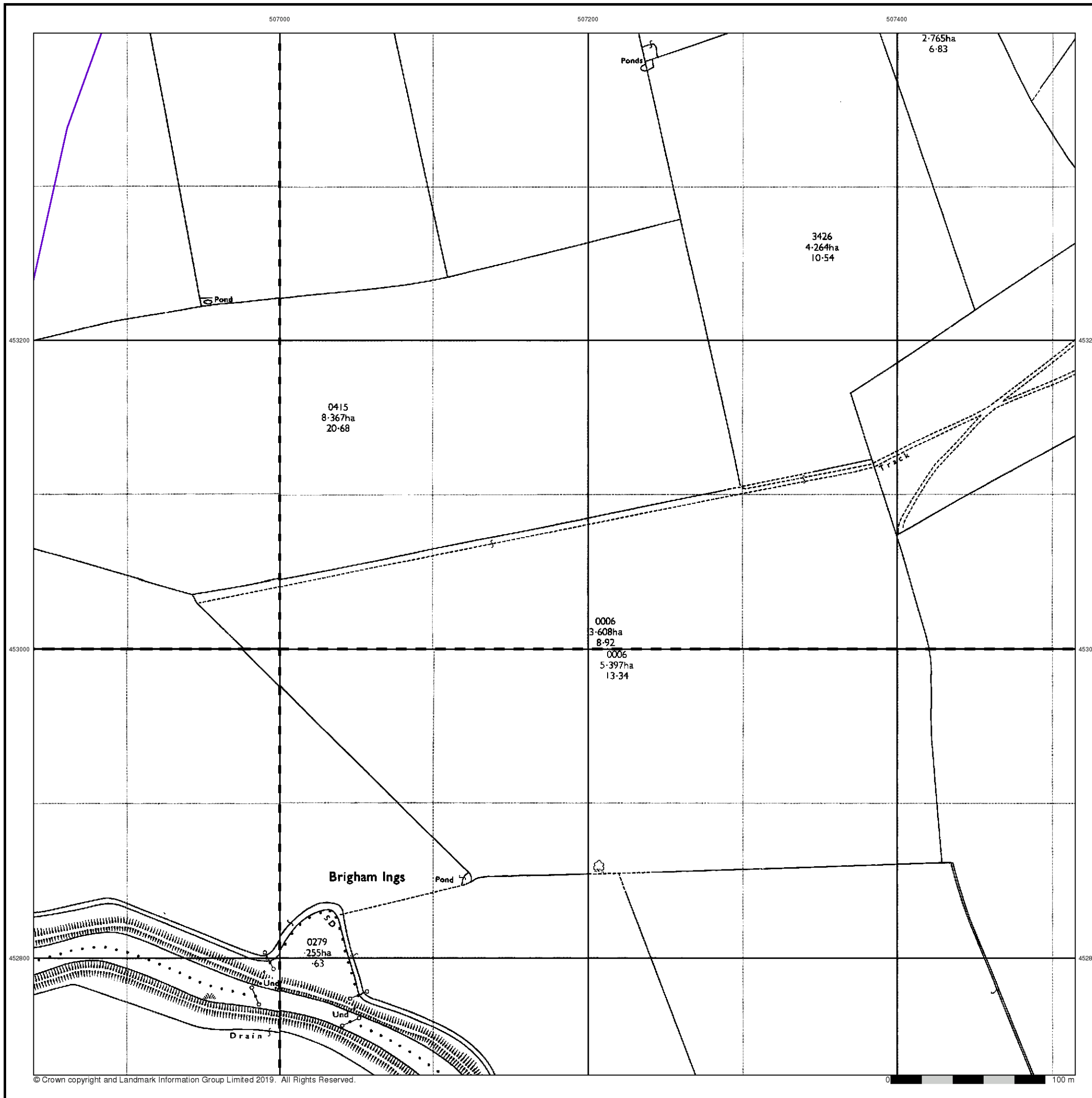

Large-Scale National Grid Data

Published 1995

Source map scale - 1:2,500

'Large Scale National Grid Data' superseded SIM cards (Ordnance Survey's 'Survey of Information on Microfilm') in 1992, and continued to be produced until 1999. These maps were the fore-runners of digital mapping and so provide detailed information on houses and roads, but tend to show less topographic features such as vegetation. These maps were produced at both 1:2,500 and 1:1,250 scales.

Map Name(s) and Date(s)

TA0653 1995 1:2,500	TA0753 1995 1:2,500
TA0652 1995 1:2,500	TA0752 1995 1:2,500

Historical Map - Segment C8

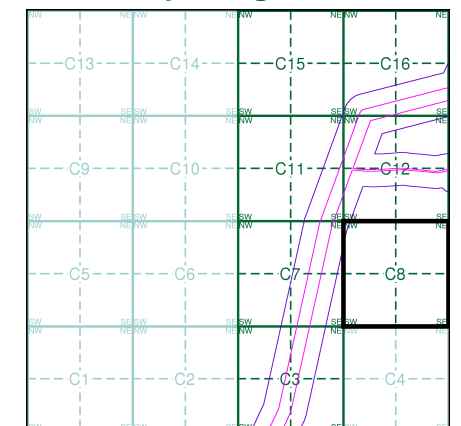

Order Details

Order Number: 201127465_1_1
 Customer Ref: PB8783-103-105
 National Grid Reference: 506560, 453280
 Slice: C
 Site Area (Ha): 72.
 Search Buffer (m): 100

Site Details

Hornsea Route

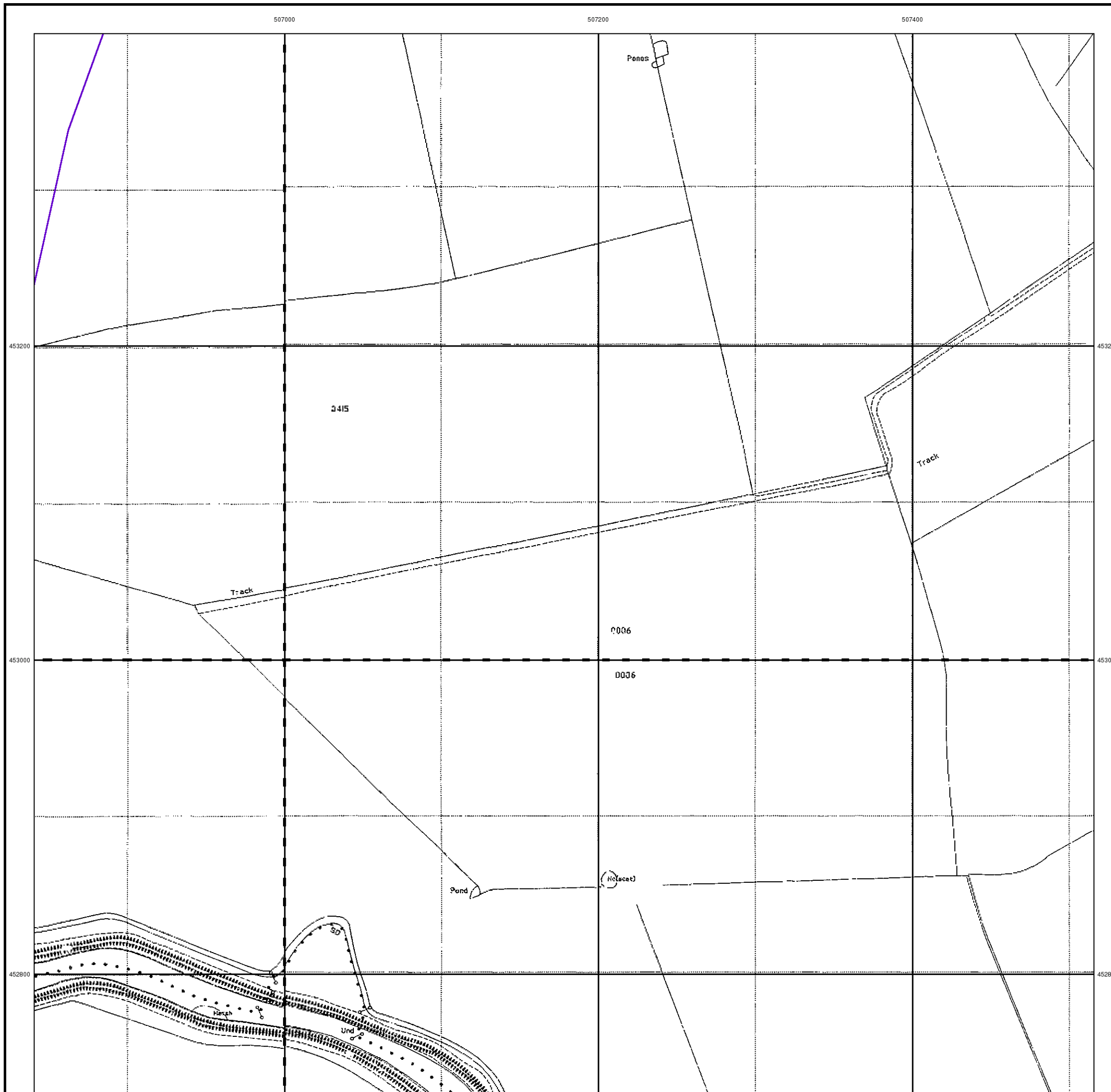

Historical Mapping Legends

Ordnance Survey County Series and Ordnance Survey Plan 1:2,500

Quarry **Gravel Pit** **Sand Pit**
Clay Pit **Shingle** **Refuse Heap**
Sloping Masonry **Flat Rock**
Marsh **Reeds** **Osiers**
Rough Pasture **Furze** **Wood**
Mixed Wood **Brushwood** **Orchard**
Fir **Ford** **Stepping Stones**
Ferry **Waterfall** **Lock**
Trig. Station **Altitude at Trig. Station**
B.M. 325.9 **Bench Mark** **Surface Level**
Arrow denotes flow of water **Antiquities (site of)**
Cutting **Embankment**
Railway crossing Road **Level Crossing** **Road crossing Railway**
Railway crossing River or Canal **Road over single stream** **Road over River or Canal**
County Boundary (Geographical)
County & Civil Parish Boundary
Administrative County & Civil Parish Boundary
County Borough Boundary (England)
County Burgh Boundary (Scotland)
Co. Boro. Bdy.
Co. Burgh Bdy.
BP BS Boundary Post or Stone **P.C.B** Police Call Box
B.R. Bridle Road **P** Pump
E.P Electricity Pylon **S.P** Signal Post
F.B. Foot Bridge **SL** Sluice
F.P. Foot Path **Sp.** Spring
G.P Guide Post or Board **T.C.B** Telephone Call Box
M.S Mile Stone **Tr.** Trough
M.P M.R Mooring Post or Ring **W** Well

Ordnance Survey Plan, Additional SIMs and Supply of Unpublished Survey Information 1:2,500 and 1:1,250

Inactive Quarry, Chalk Pit or Clay Pit **Active Quarry, Chalk Pit or Clay Pit**
Rock **Boulders**
Cliff **Slopes** **Top**
Roofed Building **Glazed Roof Building**
Sloping Masonry **Archway**
Non-Coniferous Tree (surveyed) **Coniferous Tree (surveyed)**
Non-Coniferous Trees (not surveyed) **Coniferous Trees (not surveyed)**
Orchard Tree **Scrub** **Bracken**
Coppice, Osier **Reeds** **Marsh, Saltings**
Rough Grassland **Heath** **Culvert**
Direction of water flow **Bench Mark** **Antiquity (site of)**
Cave Entrance **Triangulation Station** **Electricity Pylon**
Electricity Transmission Line
County Boundary (Geographical)
County & Civil Parish Boundary
Civil Parish Boundary
Admin. County or County Bor. Boundary
London Borough Boundary
Symbol marking point where boundary mereing changes
BH Beer House **P** Pillar, Pole or Post
BP, BS Boundary Post or Stone **PO** Post Office
Cn, C Capstan, Crane **PC** Public Convenience
Chy Chimney **PH** Public House
D Fn Drinking Fountain **Pp** Pump
EI P Electricity Pillar or Post **SB, S Br** Signal Box or Bridge
FAP Fire Alarm Pillar **SP, SL** Signal Post or Light
FB Foot Bridge **Spr** Spring
GP Guide Post **Tk** Tank or Track
H Hydrant or Hydraulic **TCB** Telephone Call Box
LC Level Crossing **TCP** Telephone Call Post
MH Manhole **Tr** Trough
MP Mile Post or Mooring Post **Wr Pt, Wr T** Water Point, Water Tap
MS Mile Stone **W** Well
NTL Normal Tidal Limit **Wd Pp** Wind Pump

Large-Scale National Grid Data 1:2,500 and 1:1,250

Cliff **Slopes** **Top**
Rock **Rock (scattered)**
Boulders **Boulders (scattered)**
Positioned Boulder **Scree**
Non-Coniferous Tree (surveyed) **Coniferous Tree (surveyed)**
Non-Coniferous Trees (not surveyed) **Coniferous Trees (not surveyed)**
Orchard Tree **Scrub** **Bracken**
Coppice, Osier **Reeds** **Marsh, Saltings**
Rough Grassland **Heath** **Culvert**
Direction of water flow **Triangulation Station** **Antiquity (site of)**
Electricity Transmission Line **Electricity Pylon**
B.M. 231.60m **Bench Mark** **Buildings with Building Seed**
Roofed Building **Glazed Roof Building**
Civil parish/community boundary
District boundary
County boundary
Boundary post/stone
Boundary mereing symbol (note: these always appear in opposed pairs or groups of three)
Bks Barracks **P** Pillar, Pole or Post
Bty Battery **PO** Post Office
Cemy Cemetery **PC** Public Convenience
Chy Chimney **Pp** Pump
Cis Cistern **Ppg Sta** Pumping Station
Dismtd Rly Dismantled Railway **PW** Place of Worship
EI Gen Sta Electricity Generating Station **Sewage Ppg Sta** Sewage Pumping Station
EI P Electricity Pole, Pillar **SB, S Br** Signal Box or Bridge
EI Sub Sta Electricity Sub Station **SP, SL** Signal Post or Light
FB Filter Bed **Spr** Spring
Fn / D Fn Fountain / Drinking Ftn. **Tk** Tank or Track
Gas Gov Gas Valve Compound **Tr** Trough
GVC Gas Governor **Wd Pp** Wind Pump
GP Guide Post **Wr Pt, Wr T** Water Point, Water Tap
MH Manhole **Wks** Works (building or area)
MP, MS Mile Post or Mile Stone **W** Well

Envirocheck

LANDMARK INFORMATION GROUP

Historical Mapping & Photography included:

Mapping Type	Scale	Date	Pg
Yorkshire	1:2,500	1892	2
Yorkshire	1:2,500	1910	3
Yorkshire	1:2,500	1927	4
Ordnance Survey Plan	1:2,500	1976	5
Large-Scale National Grid Data	1:2,500	1995	6

Historical Map - Segment C9

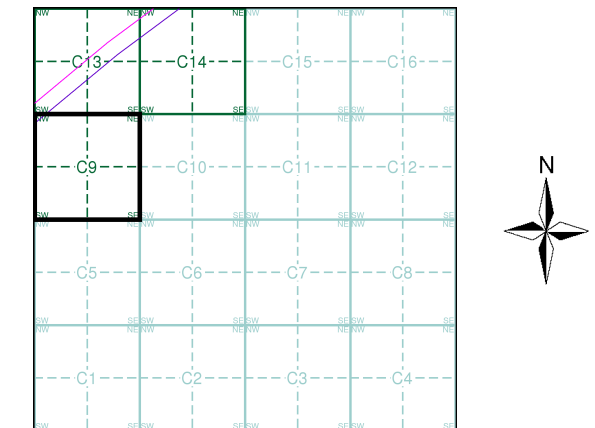

Order Details

Order Number: 201127462_1_1
 Customer Ref: PB8783-103-105
 National Grid Reference: 514690, 456000
 Slice: C
 Site Area (Ha): 2345.09
 Search Buffer (m): 100

Site Details

Hornsea Route

Landmark
 INFORMATION GROUP

Tel: 0844 844 9952
 Fax: 0844 844 9951
 Web: www.envirocheck.co.uk

Yorkshire

Published 1892

Source map scale - 1:2,500

The historical maps shown were reproduced from maps predominantly held at the scale adopted for England, Wales and Scotland in the 1840's. In 1854 the 1:2,500 scale was adopted for mapping urban areas and by 1896 it covered the whole of what were considered to be the cultivated parts of Great Britain. The published date given below is often some years later than the surveyed date. Before 1938, all OS maps were based on the Cassini Projection, with independent surveys of a single county or group of counties, giving rise to significant inaccuracies in outlying areas.

Map Name(s) and Date(s)

162_16 1892 1:2,500	163_13 1892 1:2,500
179_04 1892 1:2,500	180_01 1892 1:2,500

Historical Map - Segment C9

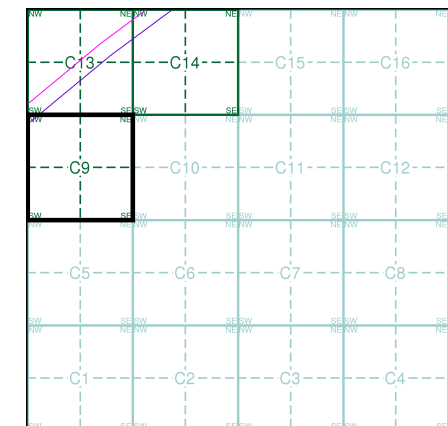

Order Details

Order Number: 201127462_1_1
 Customer Ref: PB8783-103-105
 National Grid Reference: 514690, 456000
 Slice: C
 Site Area (Ha): 2345.09
 Search Buffer (m): 100

Site Details

Hornsea Route

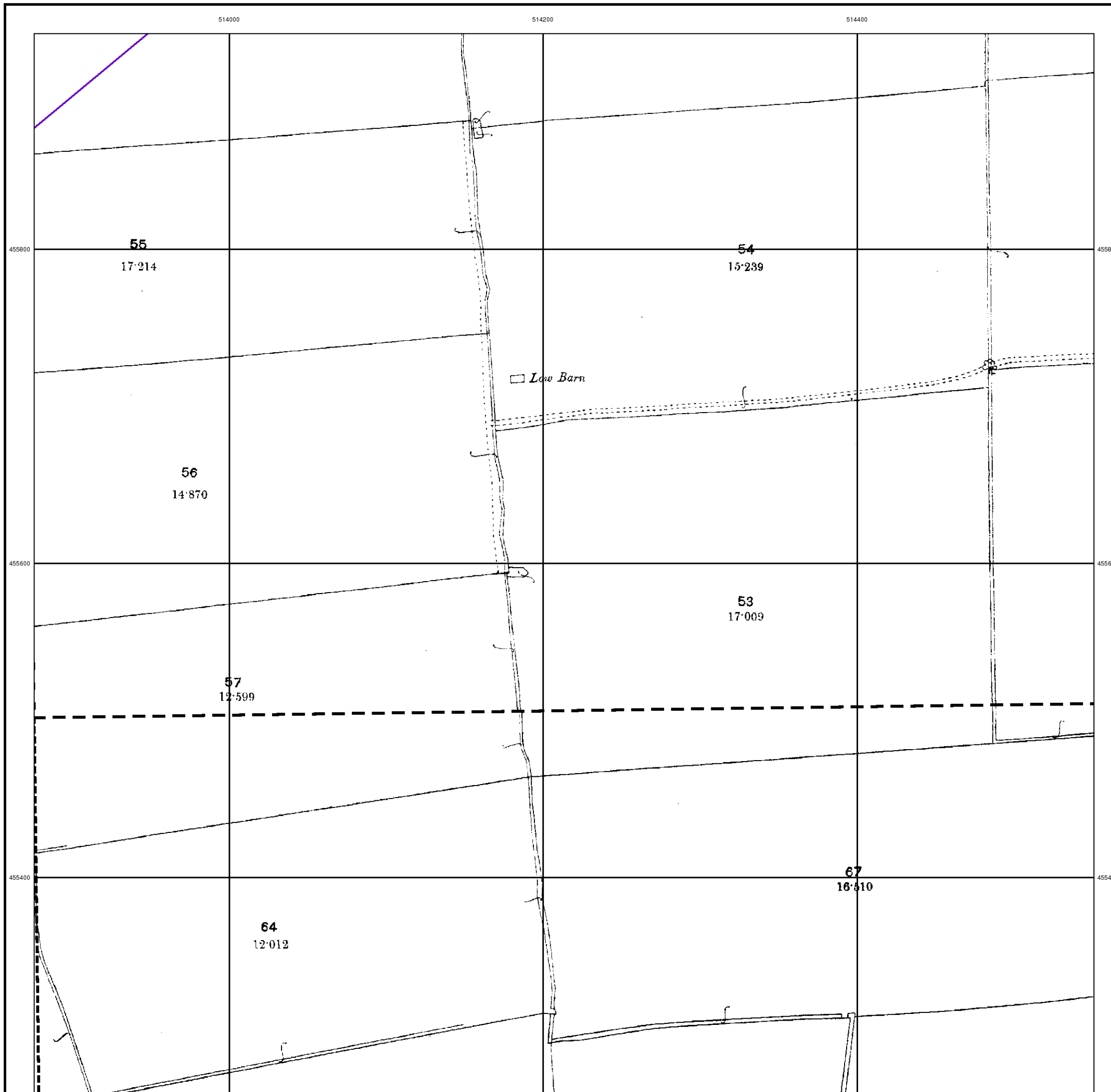

The historical maps shown were reproduced from maps predominantly held at the scale adopted for England, Wales and Scotland in the 1840's. In 1854 the 1:2,500 scale was adopted for mapping urban areas and by 1896 it covered the whole of what were considered to be the cultivated parts of Great Britain. The published date given below is often some years later than the surveyed date. Before 1938, all OS maps were based on the Cassini Projection, with independent surveys of a single county or group of counties, giving rise to significant inaccuracies in outlying areas.

Map Name(s) and Date(s)

162_16 1910 1:2,500	163_13 1910 1:2,500
179_04 1910 1:2,500	180_01 1910 1:2,500

Historical Map - Segment C9

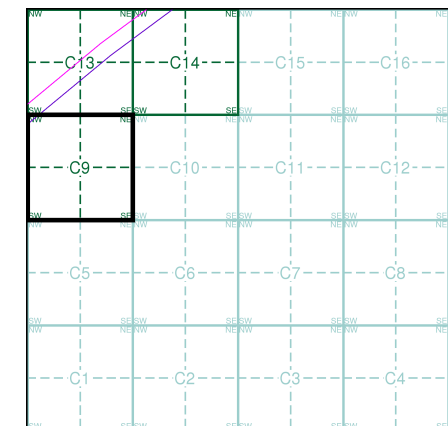

Order Details

Order Number: 201127462_1_1
 Customer Ref: PB8783-103-105
 National Grid Reference: 514690, 456000
 Slice: C
 Site Area (Ha): 2345.09
 Search Buffer (m): 100

Site Details

Hornsea Route

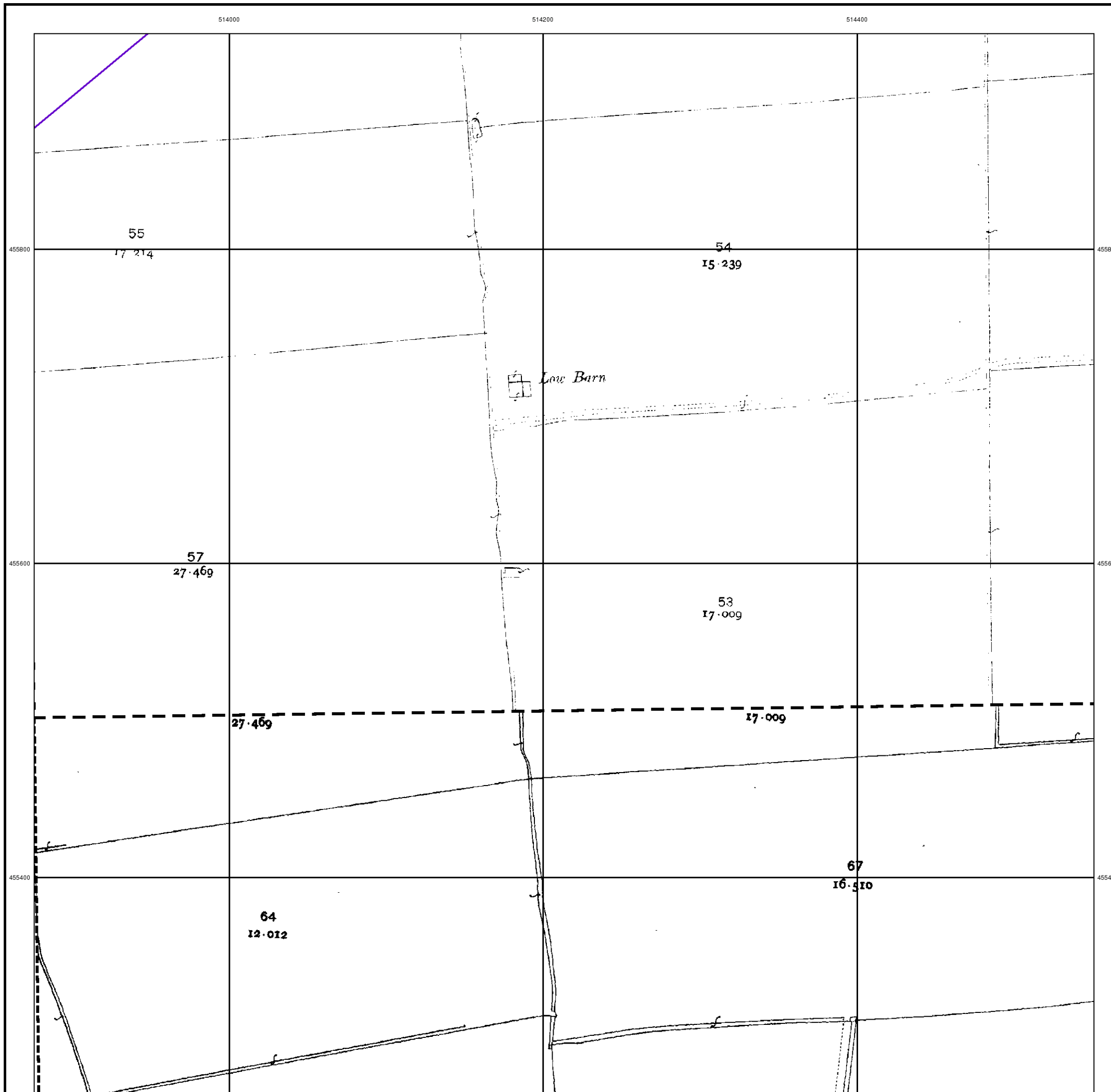

The historical maps shown were reproduced from maps predominantly held at the scale adopted for England, Wales and Scotland in the 1840's. In 1854 the 1:2,500 scale was adopted for mapping urban areas and by 1896 it covered the whole of what were considered to be the cultivated parts of Great Britain. The published date given below is often some years later than the surveyed date. Before 1938, all OS maps were based on the Cassini Projection, with independent surveys of a single county or group of counties, giving rise to significant inaccuracies in outlying areas.

Map Name(s) and Date(s)

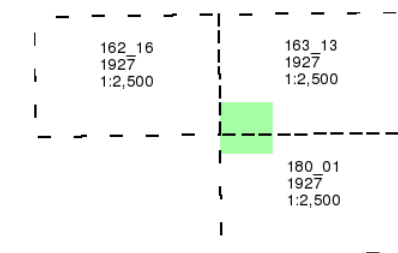

Historical Map - Segment C9

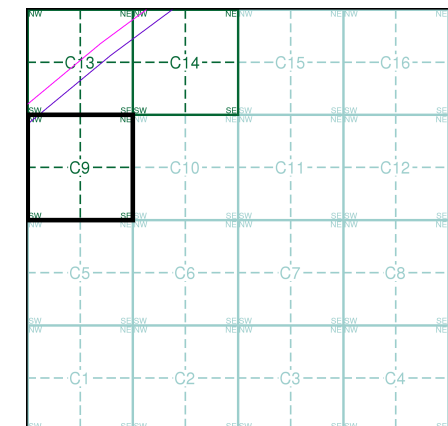

Order Details

Order Number: 201127462_1_1
 Customer Ref: PB8783-103-105
 National Grid Reference: 514690, 456000
 Slice: C
 Site Area (Ha): 2345.09
 Search Buffer (m): 100

Site Details

Hornsea Route

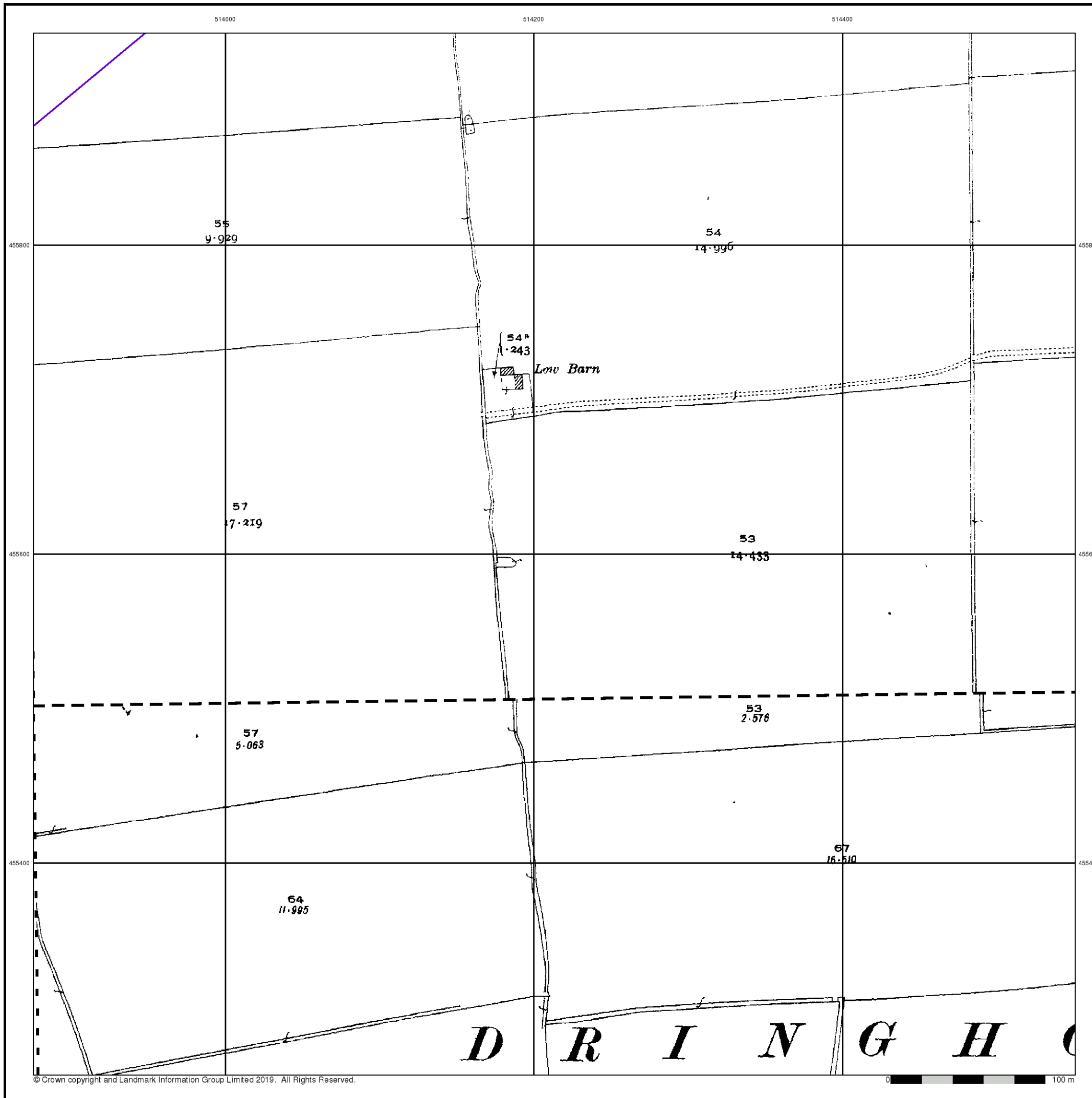

Ordnance Survey Plan

Published 1976

Source map scale - 1:2,500

The historical maps shown were reproduced from maps predominantly held at the scale adopted for England, Wales and Scotland in the 1840's. In 1854 the 1:2,500 scale was adopted for mapping urban areas and by 1896 it covered the whole of what were considered to be the cultivated parts of Great Britain. The published date given below is often some years later than the surveyed date. Before 1938, all OS maps were based on the Cassini Projection, with independent surveys of a single county or group of counties, giving rise to significant inaccuracies in outlying areas.

Map Name(s) and Date(s)

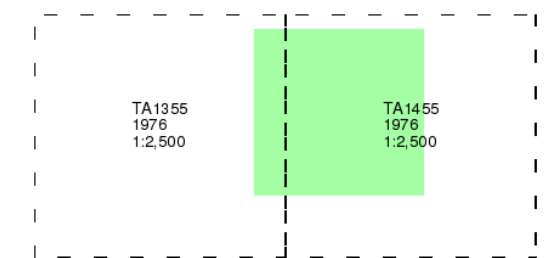

Historical Map - Segment C9

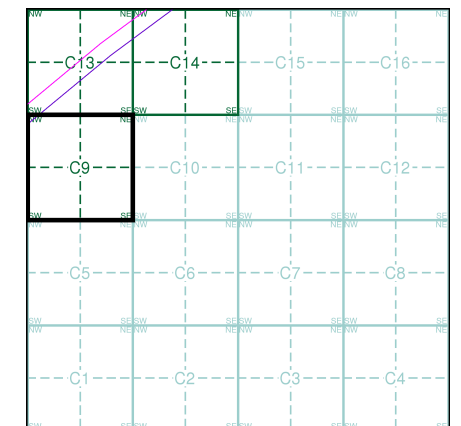

Order Details

Order Number: 201127462_1_1
Customer Ref: PB8783-103-105
National Grid Reference: 514690, 456000
Slice: C
Site Area (Ha): 2345.09
Search Buffer (m): 100

Site Details

Hornsea Route



Large-Scale National Grid Data

Published 1995

Source map scale - 1:2,500

'Large Scale National Grid Data' superseded SIM cards (Ordnance Survey's 'Survey of Information on Microfilm') in 1992, and continued to be produced until 1999. These maps were the fore-runners of digital mapping and so provide detailed information on houses and roads, but tend to show less topographic features such as vegetation. These maps were produced at both 1:2,500 and 1:1,250 scales.

Map Name(s) and Date(s)

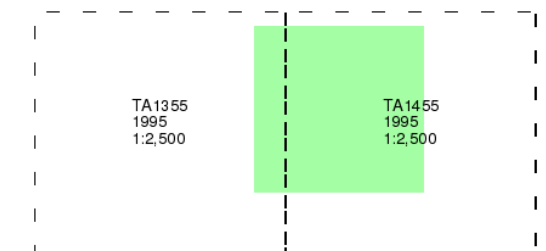

Historical Map - Segment C9

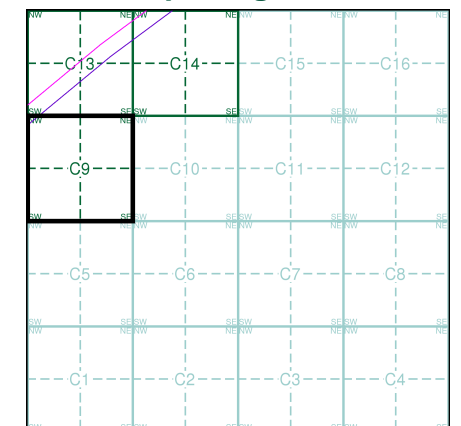

Order Details

Order Number: 201127462_1_1
Customer Ref: PB8783-103-105
National Grid Reference: 514690, 456000
Slice: C
Site Area (Ha): 2345.09
Search Buffer (m): 100

Site Details

Hornsea Route



Historical Mapping Legends

Ordnance Survey County Series and Ordnance Survey Plan 1:2,500

Quarry **Gravel Pit** **Sand Pit**
Clay Pit **Shingle** **Refuse Heap**
Sloping Masonry **Flat Rock**
Marsh **Reeds** **Osiers**
Rough Pasture **Furze** **Wood**
Mixed Wood **Brushwood** **Orchard**
Fir **Ford** **Stepping Stones**
Ferry **Waterfall** **Lock**
Trig. Station **Altitude at Trig. Station**
B.M. 325.9 **Bench Mark** **Surface Level**
Arrow denotes flow of water **Antiquities (site of)**
Cutting **Embankment**
Railway crossing Road **Level Crossing** **Road crossing Railway**
Railway crossing River or Canal **Road over single stream** **Road over River or Canal**
County Boundary (Geographical)
County & Civil Parish Boundary
Administrative County & Civil Parish Boundary
County Borough Boundary (England)
County Burgh Boundary (Scotland)
Co. Boro. Bdy.
Co. Burgh Bdy.
BP BS Boundary Post or Stone **P.C.B** Police Call Box
B.R. Bridle Road **P** Pump
E.P Electricity Pylon **S.P** Signal Post
F.B. Foot Bridge **SL** Sluice
F.P. Foot Path **Sp.** Spring
G.P Guide Post or Board **T.C.B** Telephone Call Box
M.S Mile Stone **Tr.** Trough
M.P M.R Mooring Post or Ring **W** Well

Ordnance Survey Plan, Additional SIMs and Supply of Unpublished Survey Information 1:2,500 and 1:1,250

Inactive Quarry, Chalk Pit or Clay Pit **Active Quarry, Chalk Pit or Clay Pit**
Rock **Boulders**
Cliff **Slopes** **Top**
Roofed Building **Glazed Roof Building**
Sloping Masonry **Archway**
Non-Coniferous Tree (surveyed) **Coniferous Tree (surveyed)**
Non-Coniferous Trees (not surveyed) **Coniferous Trees (not surveyed)**
Orchard Tree **Scrub** **Bracken**
Coppice, Osier **Reeds** **Marsh, Saltings**
Rough Grassland **Heath** **Culvert**
Direction of water flow **Bench Mark** **Antiquity (site of)**
Cave Entrance **Triangulation Station** **Electricity Pylon**
Electricity Transmission Line
County Boundary (Geographical)
County & Civil Parish Boundary
Civil Parish Boundary
Admin. County or County Bor. Boundary
London Borough Boundary
Symbol marking point where boundary mereing changes
BH Beer House **P** Pillar, Pole or Post
BP, BS Boundary Post or Stone **PO** Post Office
Cn, C Capstan, Crane **PC** Public Convenience
Chy Chimney **PH** Public House
D Fn Drinking Fountain **Pp** Pump
EI P Electricity Pillar or Post **SB, S Br** Signal Box or Bridge
FAP Fire Alarm Pillar **SP, SL** Signal Post or Light
FB Foot Bridge **Spr** Spring
GP Guide Post **Tk** Tank or Track
H Hydrant or Hydraulic **TCB** Telephone Call Box
LC Level Crossing **TCP** Telephone Call Post
MH Manhole **Tr** Trough
MP Mile Post or Mooring Post **Wr Pt, Wr T** Water Point, Water Tap
MS Mile Stone **W** Well
NTL Normal Tidal Limit **Wd Pp** Wind Pump

Large-Scale National Grid Data 1:2,500 and 1:1,250

Cliff **Slopes** **Top**
Rock **Rock (scattered)**
Boulders **Boulders (scattered)**
Positioned Boulder **Scree**
Non-Coniferous Tree (surveyed) **Coniferous Tree (surveyed)**
Non-Coniferous Trees (not surveyed) **Coniferous Trees (not surveyed)**
Orchard Tree **Scrub** **Bracken**
Coppice, Osier **Reeds** **Marsh, Saltings**
Rough Grassland **Heath** **Culvert**
Direction of water flow **Triangulation Station** **Antiquity (site of)**
Electricity Transmission Line **Electricity Pylon**
B.M. 231.60m Bench Mark **Buildings with Building Seed**
Roofed Building **Glazed Roof Building**
Civil parish/community boundary
District boundary
County boundary
Boundary post/stone
Boundary mereing symbol (note: these always appear in opposed pairs or groups of three)
Bks Barracks **P** Pillar, Pole or Post
Bty Battery **PO** Post Office
Cemy Cemetery **PC** Public Convenience
Chy Chimney **Pp** Pump
Cis Cistern **Ppg Sta** Pumping Station
Dismtd Rly Dismantled Railway **PW** Place of Worship
EI Gen Sta Electricity Generating Station **Sewage Ppg Sta** Sewage Pumping Station
EI P Electricity Pole, Pillar **SB, S Br** Signal Box or Bridge
EI Sub Sta Electricity Sub Station **SP, SL** Signal Post or Light
FB Filter Bed **Spr** Spring
Fn / D Fn Fountain / Drinking Ftn. **Tk** Tank or Track
Gas Gov Gas Valve Compound **Tr** Trough
GVC Gas Governor **Wd Pp** Wind Pump
GP Guide Post **Wr Pt, Wr T** Water Point, Water Tap
MH Manhole **Wks** Works (building or area)
MP, MS Mile Post or Mile Stone **W** Well

Envirocheck®

LANDMARK INFORMATION GROUP®

Historical Mapping & Photography included:

Mapping Type	Scale	Date	Pg
Yorkshire	1:2,500	1892	2
Yorkshire	1:2,500	1910	3
Ordnance Survey Plan	1:2,500	1976	4
Large-Scale National Grid Data	1:2,500	1995	5

Historical Map - Segment C11

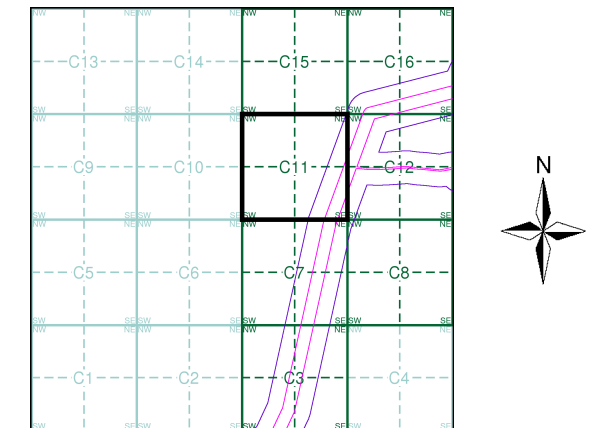

Order Details

Order Number: 201127465_1_1
 Customer Ref: PB8783-103-105
 National Grid Reference: 506560, 453280
 Slice: C
 Site Area (Ha): 72.
 Search Buffer (m): 100

Site Details

Hornsea Route

Landmark®
 INFORMATION GROUP

Tel: 0844 844 9952
 Fax: 0844 844 9951
 Web: www.envirocheck.co.uk

The historical maps shown were reproduced from maps predominantly held at the scale adopted for England, Wales and Scotland in the 1840's. In 1854 the 1:2,500 scale was adopted for mapping urban areas and by 1896 it covered the whole of what were considered to be the cultivated parts of Great Britain. The published date given below is often some years later than the surveyed date. Before 1938, all OS maps were based on the Cassini Projection, with independent surveys of a single county or group of counties, giving rise to significant inaccuracies in outlying areas.

Map Name(s) and Date(s)

179_01 1892 1:2,500	179_02 1892 1:2,500
179_05 1892 1:2,500	179_06 1892 1:2,500

Historical Map - Segment C11

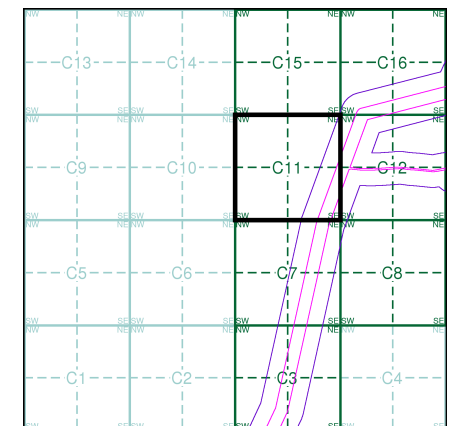

Order Details

Order Number: 201127465_1_1
 Customer Ref: PB8783-103-105
 National Grid Reference: 506560, 453280
 Slice: C
 Site Area (Ha): 72.
 Search Buffer (m): 100

Site Details

Hornsea Route

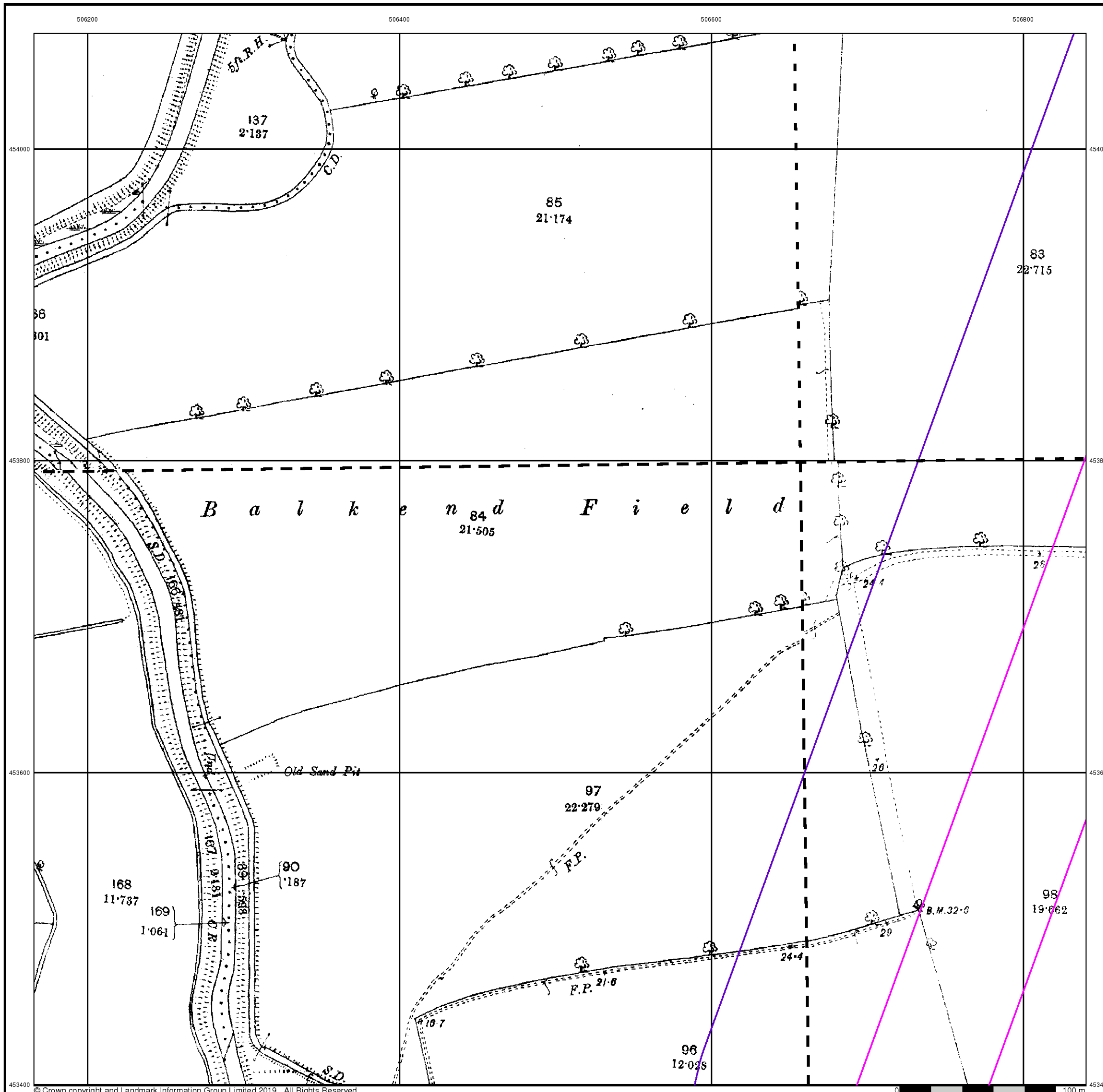

The historical maps shown were reproduced from maps predominantly held at the scale adopted for England, Wales and Scotland in the 1840's. In 1854 the 1:2,500 scale was adopted for mapping urban areas and by 1896 it covered the whole of what were considered to be the cultivated parts of Great Britain. The published date given below is often some years later than the surveyed date. Before 1938, all OS maps were based on the Cassini Projection, with independent surveys of a single county or group of counties, giving rise to significant inaccuracies in outlying areas.

Map Name(s) and Date(s)

179_01 1910 1:2,500	179_02 1910 1:2,500
179_05 1910 1:2,500	179_06 1910 1:2,500

Historical Map - Segment C11

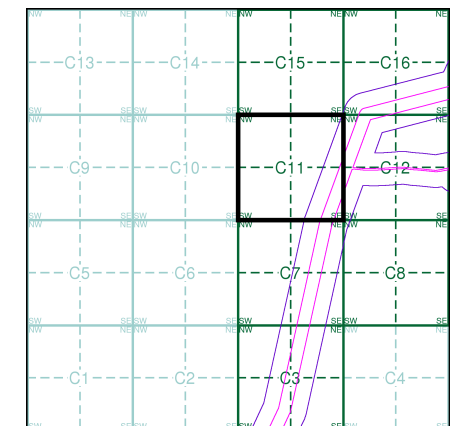

Order Details

Order Number: 201127465_1_1
 Customer Ref: PB8783-103-105
 National Grid Reference: 506560, 453280
 Slice: C
 Site Area (Ha): 72.
 Search Buffer (m): 100

Site Details

Hornsea Route

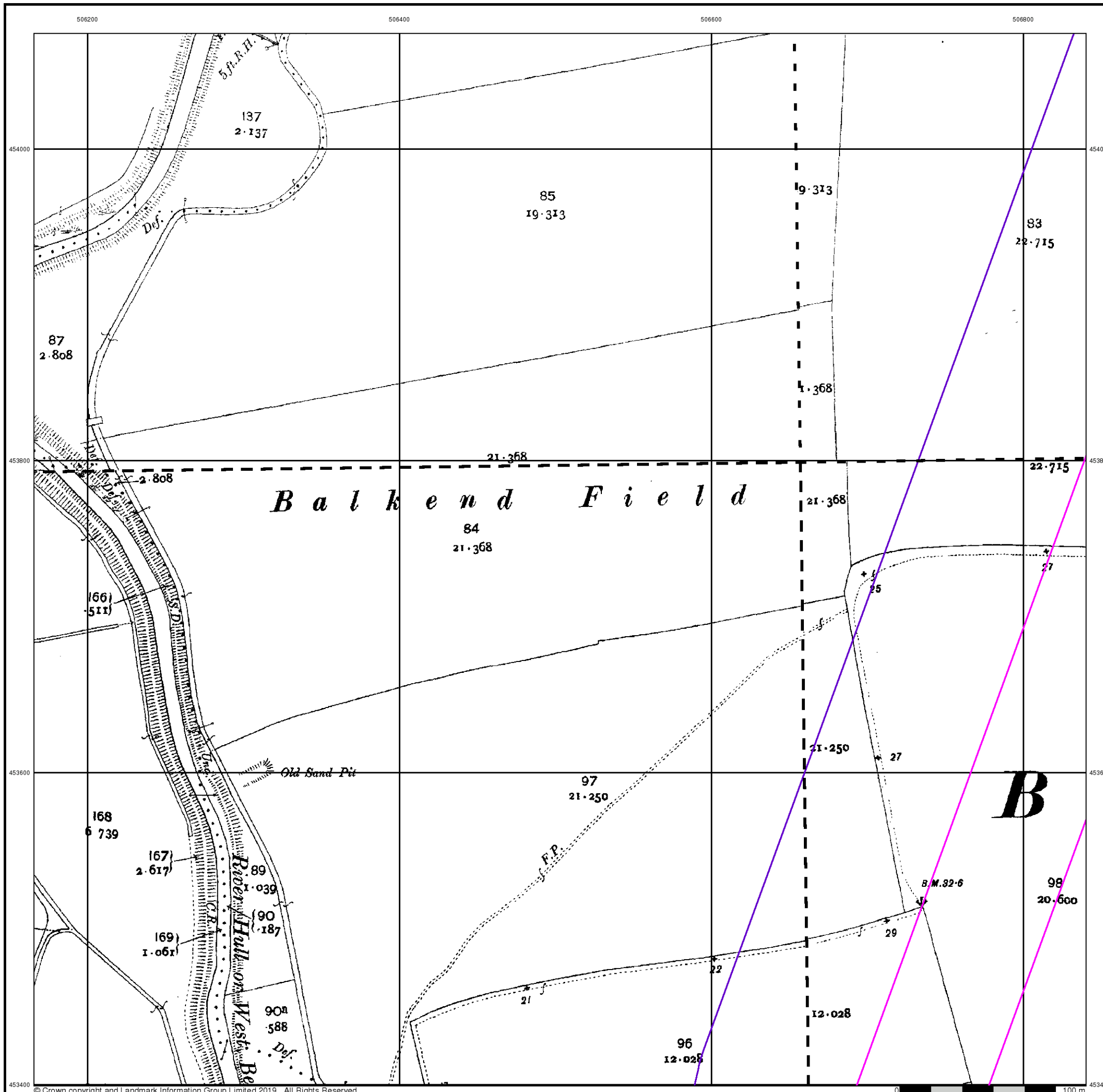

Ordnance Survey Plan

Published 1976

Source map scale - 1:2,500

The historical maps shown were reproduced from maps predominantly held at the scale adopted for England, Wales and Scotland in the 1840's. In 1854 the 1:2,500 scale was adopted for mapping urban areas and by 1896 it covered the whole of what were considered to be the cultivated parts of Great Britain. The published date given below is often some years later than the surveyed date. Before 1938, all OS maps were based on the Cassini Projection, with independent surveys of a single county or group of counties, giving rise to significant inaccuracies in outlying areas.

Map Name(s) and Date(s)

TA0654
1976
1:2,500
TA0653
1976
1:2,500

Historical Map - Segment C11

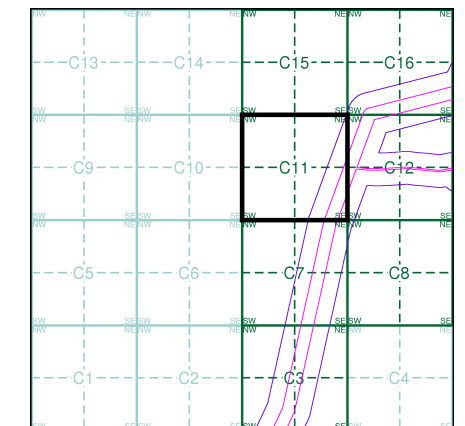

Order Details

Order Number: 201127465_1_1
 Customer Ref: PB8783-103-105
 National Grid Reference: 506560, 453280
 Slice: C
 Site Area (Ha): 72.
 Search Buffer (m): 100

Site Details

Hornsea Route

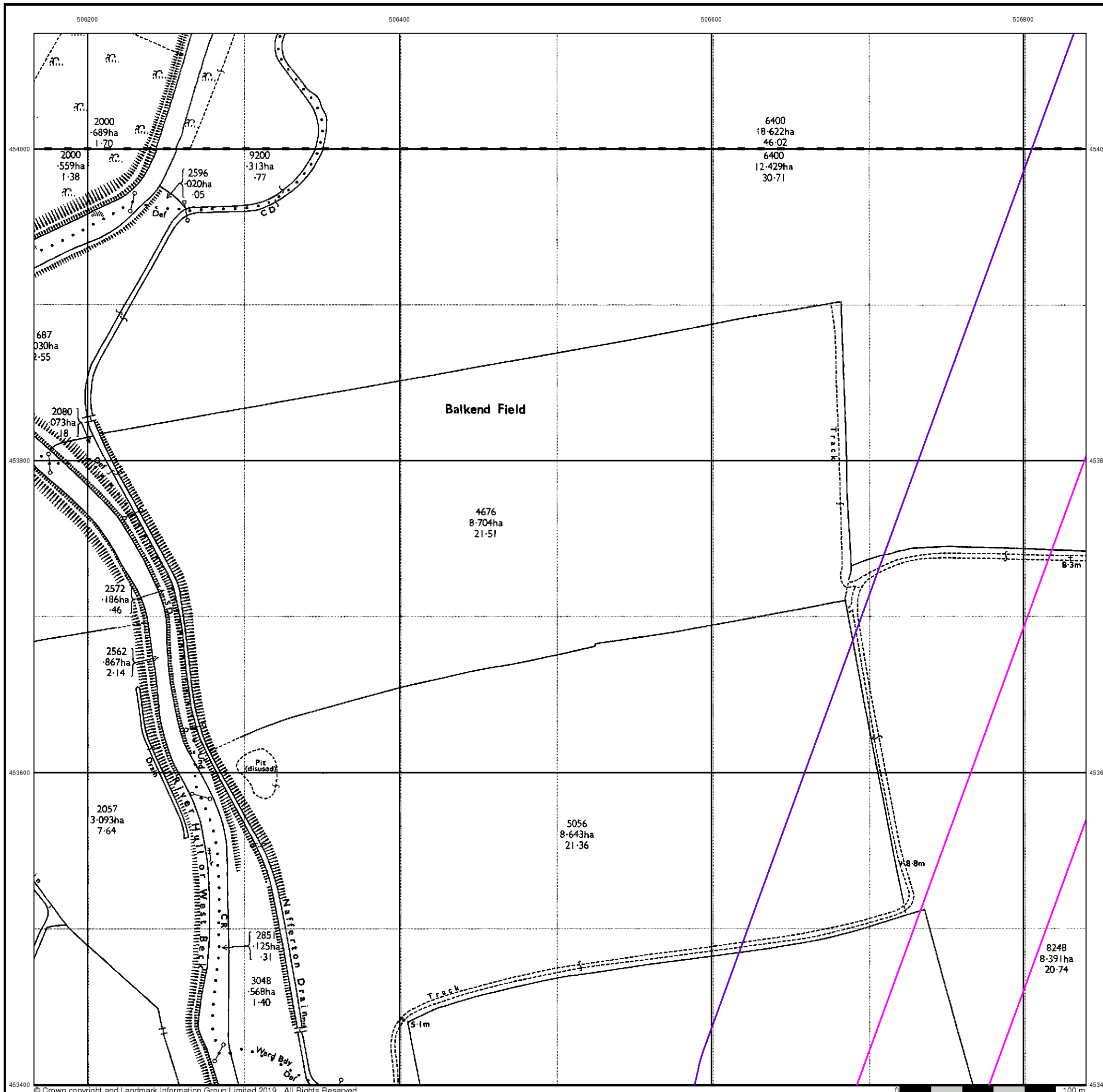

Large-Scale National Grid Data

Published 1995

Source map scale - 1:2,500

'Large Scale National Grid Data' superseded SIM cards (Ordnance Survey's 'Survey of Information on Microfilm') in 1992, and continued to be produced until 1999. These maps were the fore-runners of digital mapping and so provide detailed information on houses and roads, but tend to show less topographic features such as vegetation. These maps were produced at both 1:2,500 and 1:1,250 scales.

Map Name(s) and Date(s)

TA0654	1995	1:2,500
TA0653	1995	1:2,500

Historical Map - Segment C11

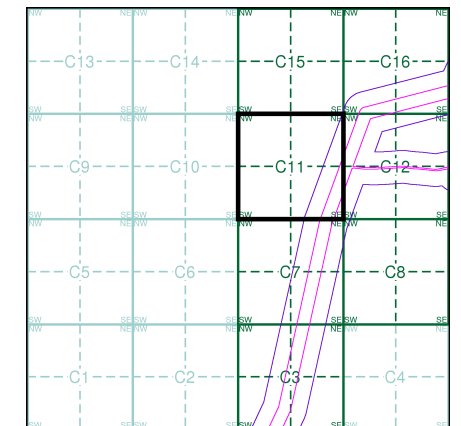

Order Details

Order Number: 201127465_1_1
 Customer Ref: PB8783-103-105
 National Grid Reference: 506560, 453280
 Slice: C
 Site Area (Ha): 72.
 Search Buffer (m): 100

Site Details

Hornsea Route



Historical Mapping Legends

Ordnance Survey County Series and Ordnance Survey Plan 1:2,500

Quarry **Gravel Pit** **Sand Pit**
Clay Pit **Shingle** **Refuse Heap**
Sloping Masonry **Flat Rock**
Marsh **Reeds** **Osiers**
Rough Pasture **Furze** **Wood**
Mixed Wood **Brushwood** **Orchard**
Fir **Ford** **Stepping Stones**
Ferry **Waterfall** **Lock**
Trig. Station **Altitude at Trig. Station**
B.M. 325.9 **Bench Mark** **Surface Level**
Arrow denotes flow of water **Antiquities (site of)**
Cutting **Embankment**
Railway crossing Road **Level Crossing** **Road crossing Railway**
Railway crossing River or Canal **Road over single stream** **Road over River or Canal**
County Boundary (Geographical)
County & Civil Parish Boundary
Administrative County & Civil Parish Boundary
County Borough Boundary (England)
County Burgh Boundary (Scotland)
Co. Boro. Bdy.
Co. Burgh Bdy.
BP BS Boundary Post or Stone **P.C.B** Police Call Box
B.R. Bridle Road **P** Pump
E.P Electricity Pylon **S.P** Signal Post
F.B. Foot Bridge **SL** Sluice
F.P. Foot Path **Sp.** Spring
G.P Guide Post or Board **T.C.B** Telephone Call Box
M.S Mile Stone **Tr.** Trough
M.P M.R Mooring Post or Ring **W** Well

Ordnance Survey Plan, Additional SIMs and Supply of Unpublished Survey Information 1:2,500 and 1:1,250

Inactive Quarry, Chalk Pit or Clay Pit **Active Quarry, Chalk Pit or Clay Pit**
Rock **Boulders**
Cliff **Slopes** **Top**
Roofed Building **Glazed Roof Building**
Sloping Masonry **Archway**
Non-Coniferous Tree (surveyed) **Coniferous Tree (surveyed)**
Non-Coniferous Trees (not surveyed) **Coniferous Trees (not surveyed)**
Orchard Tree **Scrub** **Bracken**
Coppice, Osier **Reeds** **Marsh, Saltings**
Rough Grassland **Heath** **Culvert**
Direction of water flow **Bench Mark** **Antiquity (site of)**
Cave Entrance **Triangulation Station** **Electricity Pylon**
Electricity Transmission Line
County Boundary (Geographical)
County & Civil Parish Boundary
Civil Parish Boundary
Admin. County or County Bor. Boundary
London Borough Boundary
Symbol marking point where boundary mereing changes
BH Beer House **P** Pillar, Pole or Post
BP, BS Boundary Post or Stone **PO** Post Office
Cn, C Capstan, Crane **PC** Public Convenience
Chy Chimney **PH** Public House
D Fn Drinking Fountain **Pp** Pump
EI P Electricity Pillar or Post **SB, S Br** Signal Box or Bridge
FAP Fire Alarm Pillar **SP, SL** Signal Post or Light
FB Foot Bridge **Spr** Spring
GP Guide Post **Tk** Tank or Track
H Hydrant or Hydraulic **TCB** Telephone Call Box
LC Level Crossing **TCP** Telephone Call Post
MH Manhole **Tr** Trough
MP Mile Post or Mooring Post **Wr Pt, Wr T** Water Point, Water Tap
MS Mile Stone **W** Well
NTL Normal Tidal Limit **Wd Pp** Wind Pump

Large-Scale National Grid Data 1:2,500 and 1:1,250

Cliff **Slopes** **Top**
Rock **Rock (scattered)**
Boulders **Boulders (scattered)**
Positioned Boulder **Scree**
Non-Coniferous Tree (surveyed) **Coniferous Tree (surveyed)**
Non-Coniferous Trees (not surveyed) **Coniferous Trees (not surveyed)**
Orchard Tree **Scrub** **Bracken**
Coppice, Osier **Reeds** **Marsh, Saltings**
Rough Grassland **Heath** **Culvert**
Direction of water flow **Triangulation Station** **Antiquity (site of)**
Electricity Transmission Line **Electricity Pylon**
B.M. 231.60m Bench Mark **Buildings with Building Seed**
Roofed Building **Glazed Roof Building**
Civil parish/community boundary
District boundary
County boundary
Boundary post/stone
Boundary mereing symbol (note: these always appear in opposed pairs or groups of three)
Bks Barracks **P** Pillar, Pole or Post
Bty Battery **PO** Post Office
Cemy Cemetery **PC** Public Convenience
Chy Chimney **Pp** Pump
Cis Cistern **Ppg Sta** Pumping Station
Dismtd Rly Dismantled Railway **PW** Place of Worship
EI Gen Sta Electricity Generating Station **Sewage Ppg Sta** Sewage Pumping Station
EI P Electricity Pole, Pillar **SB, S Br** Signal Box or Bridge
EI Sub Sta Electricity Sub Station **SP, SL** Signal Post or Light
FB Filter Bed **Spr** Spring
Fn / D Fn Fountain / Drinking Ftn. **Tk** Tank or Track
Gas Gov Gas Valve Compound **Tr** Trough
GVC Gas Governor **Wd Pp** Wind Pump
GP Guide Post **Wr Pt, Wr T** Water Point, Water Tap
MH Manhole **Wks** Works (building or area)
MP, MS Mile Post or Mile Stone **W** Well

Envirocheck®

LANDMARK INFORMATION GROUP®

Historical Mapping & Photography included:

Mapping Type	Scale	Date	Pg
Yorkshire	1:2,500	1892	2
Yorkshire	1:2,500	1910	3
Ordnance Survey Plan	1:2,500	1976	4
Large-Scale National Grid Data	1:2,500	1995	5

Historical Map - Segment C12

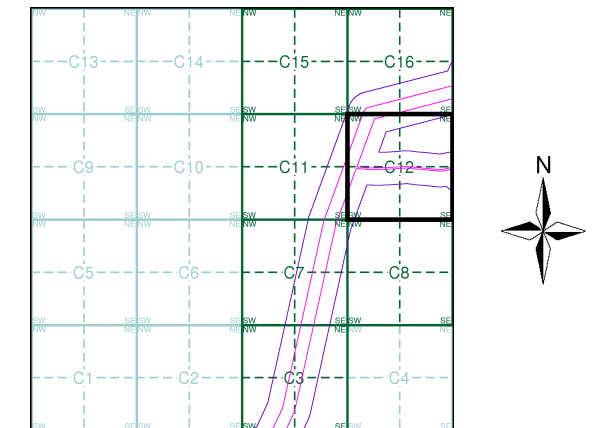

Order Details

Order Number: 201127465_1_1
 Customer Ref: PB8783-103-105
 National Grid Reference: 506560, 453280
 Slice: C
 Site Area (Ha): 72.
 Search Buffer (m): 100

Site Details

Hornsea Route

Landmark®
 INFORMATION GROUP

Tel: 0844 844 9952
 Fax: 0844 844 9951
 Web: www.envirocheck.co.uk

The historical maps shown were reproduced from maps predominantly held at the scale adopted for England, Wales and Scotland in the 1840's. In 1854 the 1:2,500 scale was adopted for mapping urban areas and by 1896 it covered the whole of what were considered to be the cultivated parts of Great Britain. The published date given below is often some years later than the surveyed date. Before 1938, all OS maps were based on the Cassini Projection, with independent surveys of a single county or group of counties, giving rise to significant inaccuracies in outlying areas.

Map Name(s) and Date(s)

179_02	1892	1:2,500
179_06	1892	1:2,500

Historical Map - Segment C12

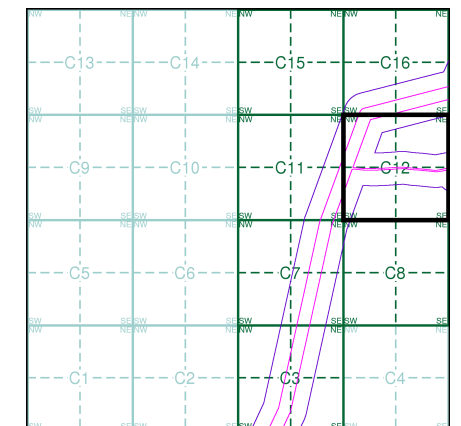

Order Details

Order Number: 201127465_1_1
 Customer Ref: PB8783-103-105
 National Grid Reference: 506560, 453280
 Slice: C
 Site Area (Ha): 72.
 Search Buffer (m): 100

Site Details

Hornsea Route

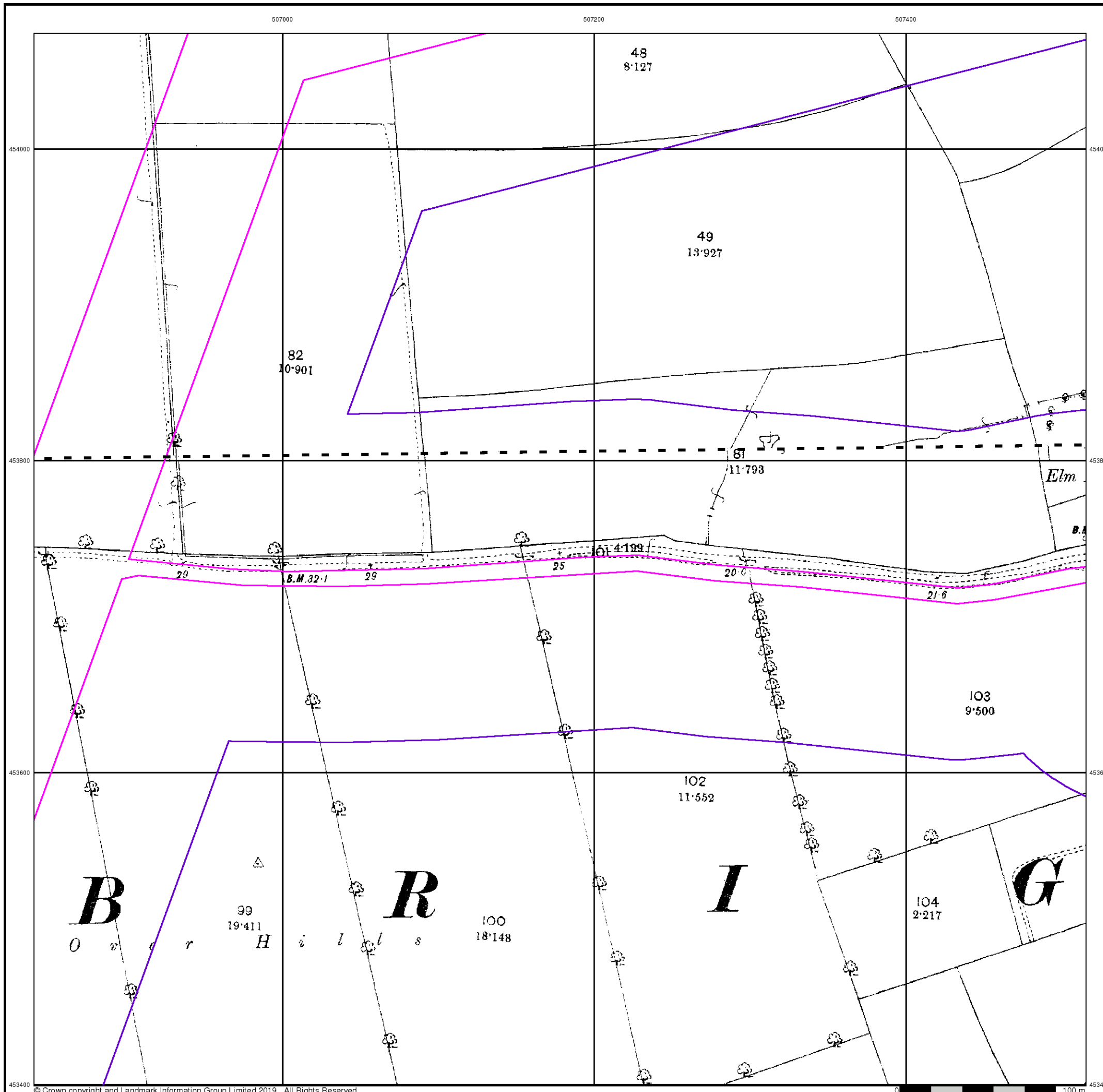

The historical maps shown were reproduced from maps predominantly held at the scale adopted for England, Wales and Scotland in the 1840's. In 1854 the 1:2,500 scale was adopted for mapping urban areas and by 1896 it covered the whole of what were considered to be the cultivated parts of Great Britain. The published date given below is often some years later than the surveyed date. Before 1938, all OS maps were based on the Cassini Projection, with independent surveys of a single county or group of counties, giving rise to significant inaccuracies in outlying areas.

Map Name(s) and Date(s)

179_02
1910
1:2,500
179_06
1910
1:2,500

Historical Map - Segment C12

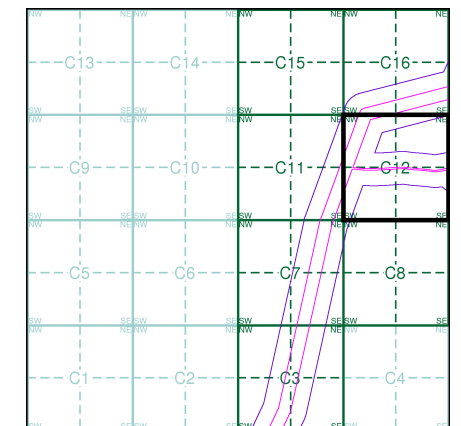

Order Details

Order Number: 201127465_1_1
 Customer Ref: PB8783-103-105
 National Grid Reference: 506560, 453280
 Slice: C
 Site Area (Ha): 72.
 Search Buffer (m): 100

Site Details

Hornsea Route

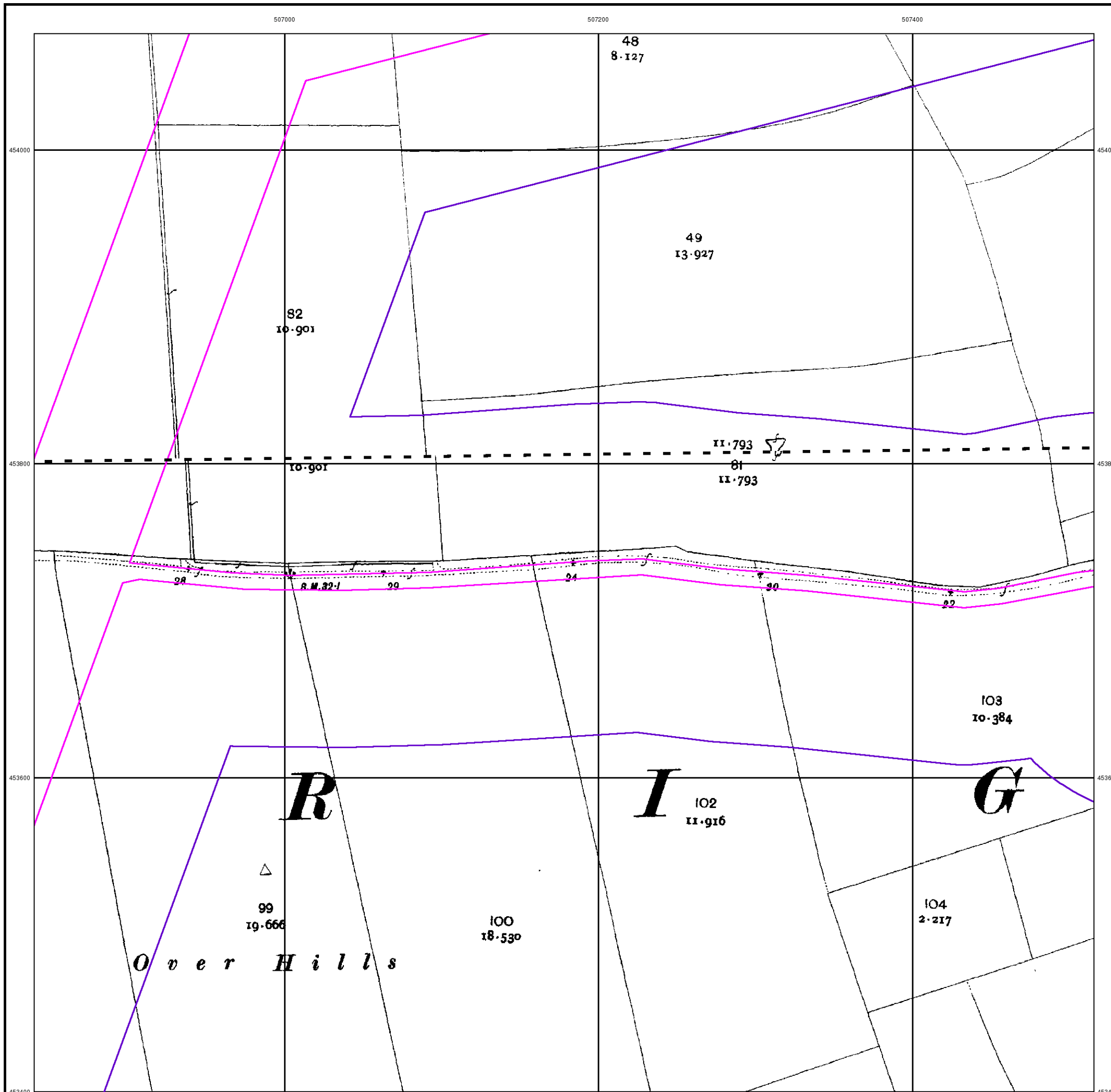

Ordnance Survey Plan

Published 1976

Source map scale - 1:2,500

The historical maps shown were reproduced from maps predominantly held at the scale adopted for England, Wales and Scotland in the 1840's. In 1854 the 1:2,500 scale was adopted for mapping urban areas and by 1896 it covered the whole of what were considered to be the cultivated parts of Great Britain. The published date given below is often some years later than the surveyed date. Before 1938, all OS maps were based on the Cassini Projection, with independent surveys of a single county or group of counties, giving rise to significant inaccuracies in outlying areas.

Map Name(s) and Date(s)

TA0654 1976 12,500	TA0754 1976 12,500
TA0653 1976 12,500	TA0753 1976 12,500

Historical Map - Segment C12

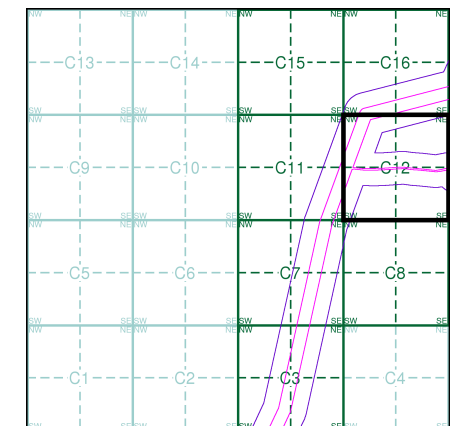

Order Details

Order Number: 201127465_1_1
 Customer Ref: PB8783-103-105
 National Grid Reference: 506560, 453280
 Slice: C
 Site Area (Ha): 72.
 Search Buffer (m): 100

Site Details

Hornsea Route

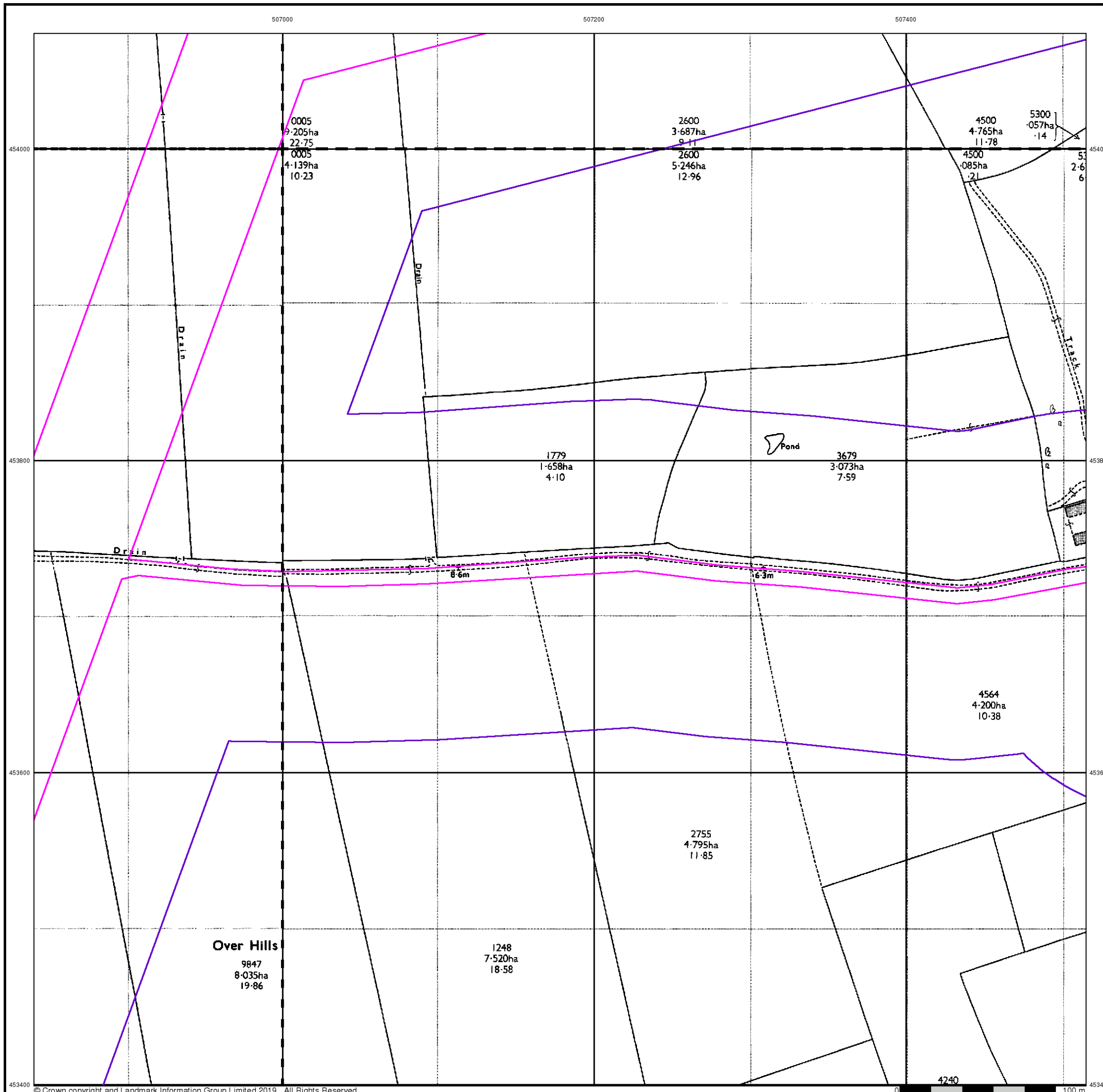

Large-Scale National Grid Data

Published 1995

Source map scale - 1:2,500

'Large Scale National Grid Data' superseded SIM cards (Ordnance Survey's 'Survey of Information on Microfilm') in 1992, and continued to be produced until 1999. These maps were the fore-runners of digital mapping and so provide detailed information on houses and roads, but tend to show less topographic features such as vegetation. These maps were produced at both 1:2,500 and 1:1,250 scales.

Map Name(s) and Date(s)

TA0654 1995 1:2,500	TA0754 1995 1:2,500
TA0653 1995 1:2,500	TA0753 1995 1:2,500

Historical Map - Segment C12

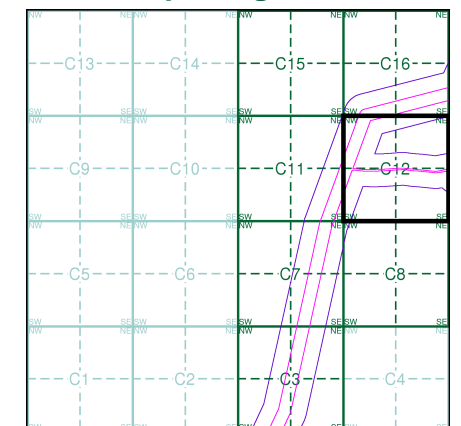

Order Details

Order Number: 201127465_1_1
 Customer Ref: PB8783-103-105
 National Grid Reference: 506560, 453280
 Slice: C
 Site Area (Ha): 72.
 Search Buffer (m): 100

Site Details

Hornsea Route

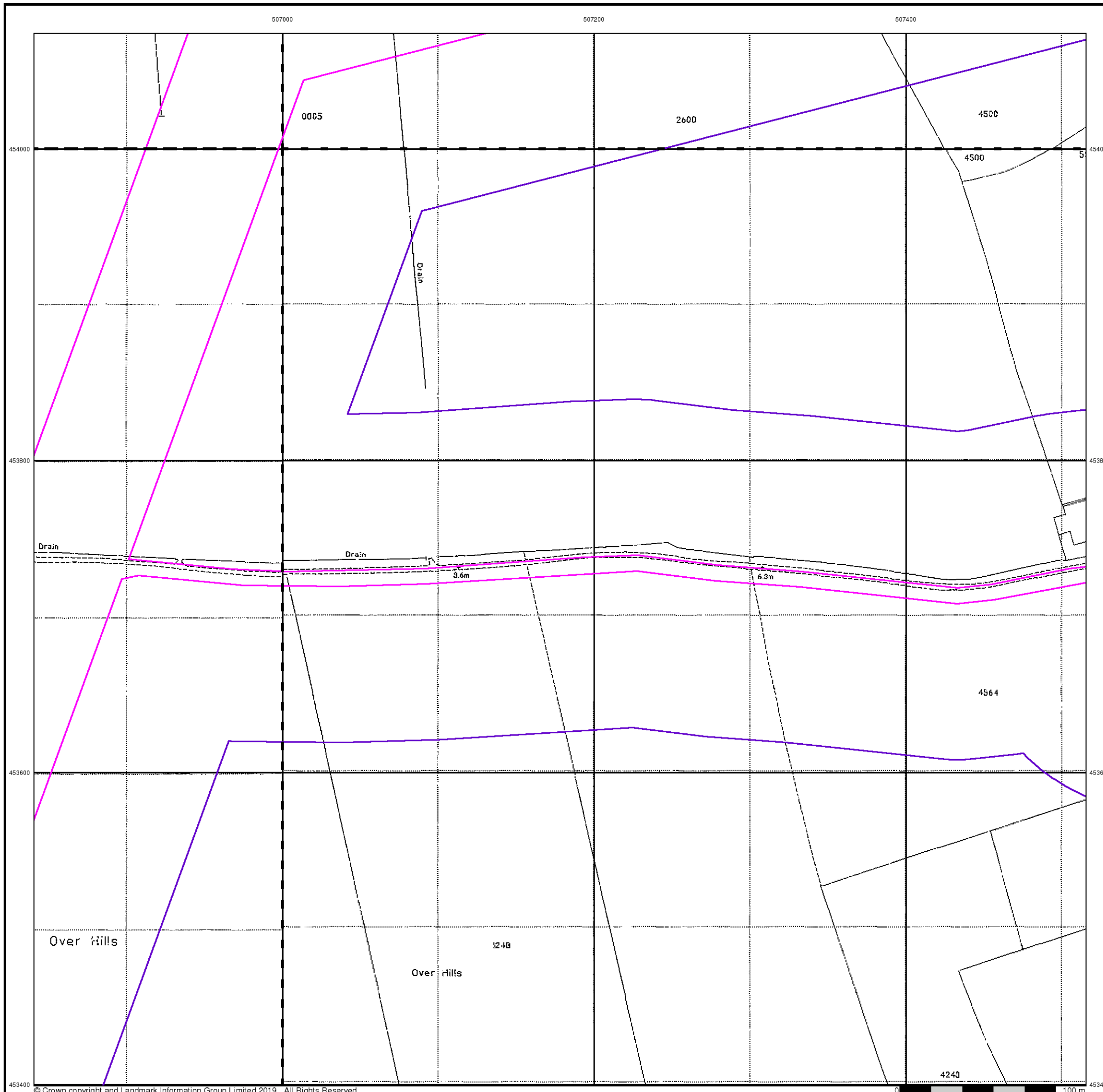

Historical Mapping Legends

Ordnance Survey County Series and Ordnance Survey Plan 1:2,500

Quarry **Gravel Pit** **Sand Pit**
Clay Pit **Shingle** **Refuse Heap**
Sloping Masonry **Flat Rock**
Marsh **Reeds** **Osiers**
Rough Pasture **Furze** **Wood**
Mixed Wood **Brushwood** **Orchard**
Fir **Ford** **Stepping Stones**
Ferry **Waterfall** **Lock**
Trig. Station **Altitude at Trig. Station**
B.M. 325.9 **Bench Mark** **Surface Level**
Arrow denotes flow of water **Antiquities (site of)**
Cutting **Embankment**
Railway crossing Road **Level Crossing** **Road crossing Railway**
Railway crossing River or Canal **Road over single stream** **Road over River or Canal**
County Boundary (Geographical)
County & Civil Parish Boundary
Administrative County & Civil Parish Boundary
County Borough Boundary (England)
County Burgh Boundary (Scotland)
Co. Boro. Bdy.
Co. Burgh Bdy.
BP BS Boundary Post or Stone **P.C.B** Police Call Box
B.R. Bridle Road **P** Pump
E.P Electricity Pylon **S.P** Signal Post
F.B. Foot Bridge **SL** Sluice
F.P. Foot Path **Sp.** Spring
G.P Guide Post or Board **T.C.B** Telephone Call Box
M.S Mile Stone **Tr.** Trough
M.P M.R Mooring Post or Ring **W** Well

Ordnance Survey Plan, Additional SIMs and Supply of Unpublished Survey Information 1:2,500 and 1:1,250

Inactive Quarry, Chalk Pit or Clay Pit **Active Quarry, Chalk Pit or Clay Pit**
Rock **Boulders**
Cliff **Slopes** **Top**
Roofed Building **Glazed Roof Building**
Sloping Masonry **Archway**
Non-Coniferous Tree (surveyed) **Coniferous Tree (surveyed)**
Non-Coniferous Trees (not surveyed) **Coniferous Trees (not surveyed)**
Orchard Tree **Scrub** **Bracken**
Coppice, Osier **Reeds** **Marsh, Saltings**
Rough Grassland **Heath** **Culvert**
Direction of water flow **Bench Mark** **Antiquity (site of)**
Cave Entrance **Triangulation Station** **Electricity Pylon**
Electricity Transmission Line
County Boundary (Geographical)
County & Civil Parish Boundary
Civil Parish Boundary
Admin. County or County Bor. Boundary
London Borough Boundary
Symbol marking point where boundary mereing changes
BH Beer House **P** Pillar, Pole or Post
BP, BS Boundary Post or Stone **PO** Post Office
Cn, C Capstan, Crane **PC** Public Convenience
Chy Chimney **PH** Public House
D Fn Drinking Fountain **Pp** Pump
EI P Electricity Pillar or Post **SB, S Br** Signal Box or Bridge
FAP Fire Alarm Pillar **SP, SL** Signal Post or Light
FB Foot Bridge **Spr** Spring
GP Guide Post **Tk** Tank or Track
H Hydrant or Hydraulic **TCB** Telephone Call Box
LC Level Crossing **TCP** Telephone Call Post
MH Manhole **Tr** Trough
MP Mile Post or Mooring Post **Wr Pt, Wr T** Water Point, Water Tap
MS Mile Stone **W** Well
NTL Normal Tidal Limit **Wd Pp** Wind Pump

Large-Scale National Grid Data 1:2,500 and 1:1,250

Cliff **Slopes** **Top**
Rock **Rock (scattered)**
Boulders **Boulders (scattered)**
Positioned Boulder **Scree**
Non-Coniferous Tree (surveyed) **Coniferous Tree (surveyed)**
Non-Coniferous Trees (not surveyed) **Coniferous Trees (not surveyed)**
Orchard Tree **Scrub** **Bracken**
Coppice, Osier **Reeds** **Marsh, Saltings**
Rough Grassland **Heath** **Culvert**
Direction of water flow **Triangulation Station** **Antiquity (site of)**
Electricity Transmission Line **Electricity Pylon**
B.M. 231.60m **Bench Mark** **Buildings with Building Seed**
Roofed Building **Glazed Roof Building**
Civil parish/community boundary
District boundary
County boundary
Boundary post/stone
Boundary mereing symbol (note: these always appear in opposed pairs or groups of three)
Bks Barracks **P** Pillar, Pole or Post
Bty Battery **PO** Post Office
Cemy Cemetery **PC** Public Convenience
Chy Chimney **Pp** Pump
Cis Cistern **Ppg Sta** Pumping Station
Dismtd Rly Dismantled Railway **PW** Place of Worship
EI Gen Sta Electricity Generating Station **Sewage Ppg Sta** Sewage Pumping Station
EI P Electricity Pole, Pillar **SB, S Br** Signal Box or Bridge
EI Sub Sta Electricity Sub Station **SP, SL** Signal Post or Light
FB Filter Bed **Spr** Spring
Fn / D Fn Fountain / Drinking Ftn. **Tk** Tank or Track
Gas Gov Gas Valve Compound **Tr** Trough
GVC Gas Governor **Wd Pp** Wind Pump
GP Guide Post **Wr Pt, Wr T** Water Point, Water Tap
MH Manhole **Wks** Works (building or area)
MP, MS Mile Post or Mile Stone **W** Well

Envirocheck®

LANDMARK INFORMATION GROUP®

Historical Mapping & Photography included:

Mapping Type	Scale	Date	Pg
Yorkshire	1:2,500	1892	2
Yorkshire	1:2,500	1910	3
Yorkshire	1:2,500	1927	4
Ordnance Survey Plan	1:2,500	1976	5
Large-Scale National Grid Data	1:2,500	1995	6

Historical Map - Segment C13

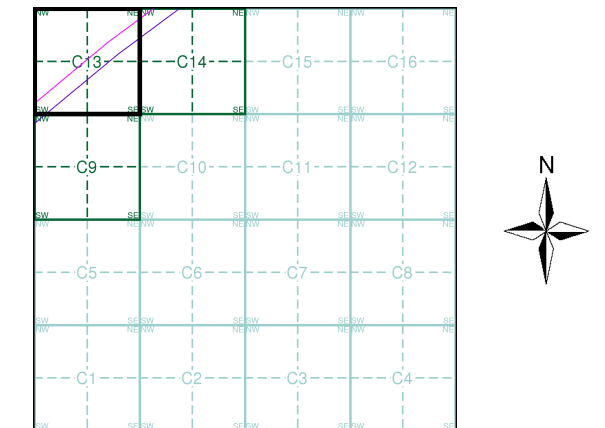

Order Details

Order Number: 201127462_1_1
 Customer Ref: PB8783-103-105
 National Grid Reference: 514690, 456000
 Slice: C
 Site Area (Ha): 2345.09
 Search Buffer (m): 100

Site Details

Hornsea Route

Landmark
 INFORMATION GROUP

Tel: 0844 844 9952
 Fax: 0844 844 9951
 Web: www.envirocheck.co.uk

Yorkshire

Published 1892

Source map scale - 1:2,500

The historical maps shown were reproduced from maps predominantly held at the scale adopted for England, Wales and Scotland in the 1840's. In 1854 the 1:2,500 scale was adopted for mapping urban areas and by 1896 it covered the whole of what were considered to be the cultivated parts of Great Britain. The published date given below is often some years later than the surveyed date. Before 1938, all OS maps were based on the Cassini Projection, with independent surveys of a single county or group of counties, giving rise to significant inaccuracies in outlying areas.

Map Name(s) and Date(s)

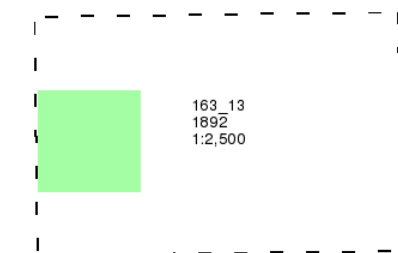

Historical Map - Segment C13

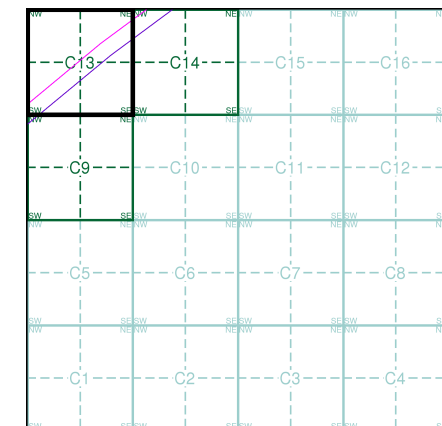

Order Details

Order Number: 201127462_1_1
 Customer Ref: PB8783-103-105
 National Grid Reference: 514690, 456000
 Slice: C
 Site Area (Ha): 2345.09
 Search Buffer (m): 100

Site Details

Hornsea Route

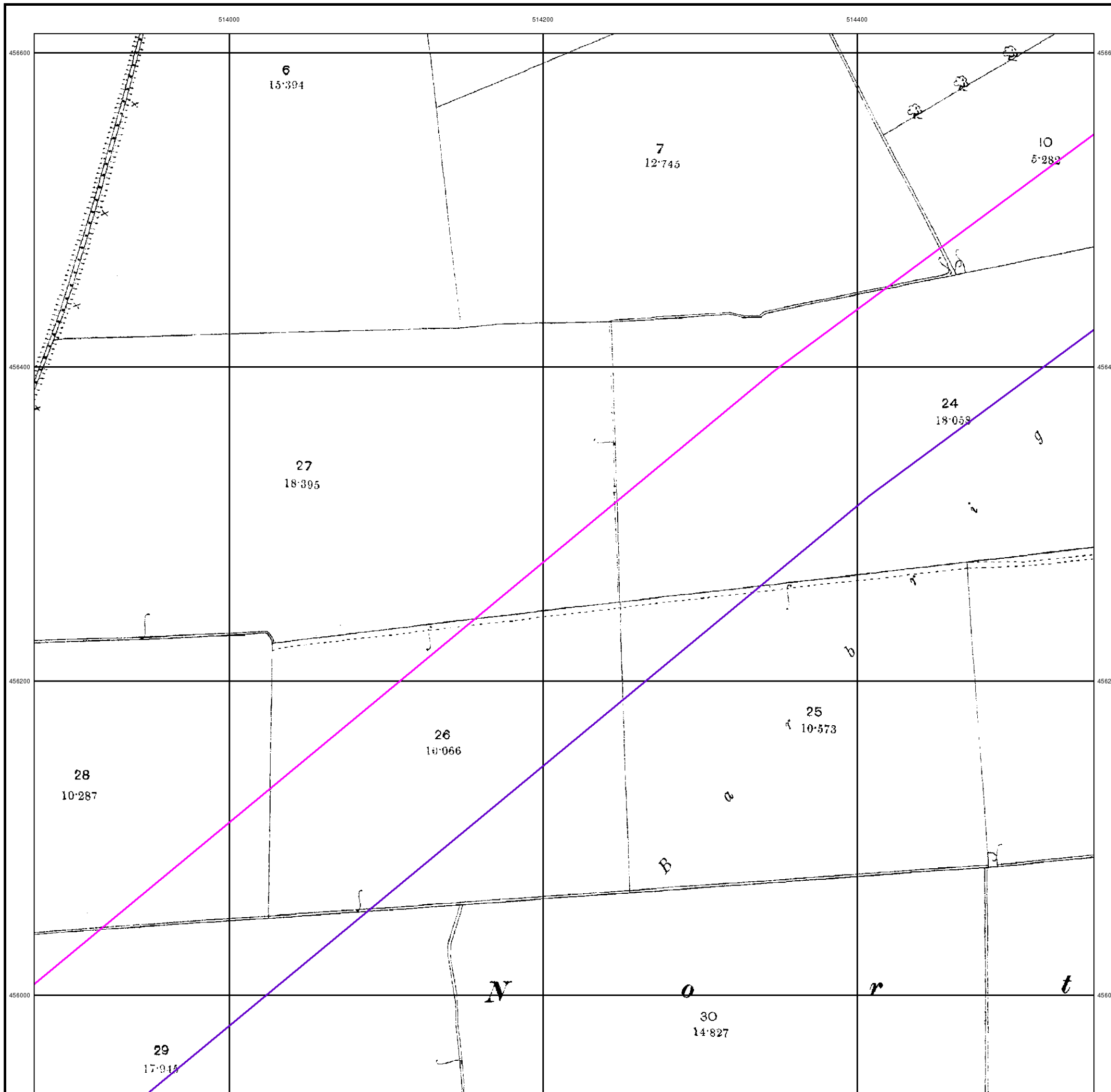

Yorkshire

Published 1910

Source map scale - 1:2,500

The historical maps shown were reproduced from maps predominantly held at the scale adopted for England, Wales and Scotland in the 1840's. In 1854 the 1:2,500 scale was adopted for mapping urban areas and by 1896 it covered the whole of what were considered to be the cultivated parts of Great Britain. The published date given below is often some years later than the surveyed date. Before 1938, all OS maps were based on the Cassini Projection, with independent surveys of a single county or group of counties, giving rise to significant inaccuracies in outlying areas.

Map Name(s) and Date(s)

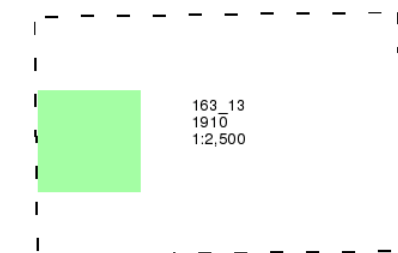

Historical Map - Segment C13

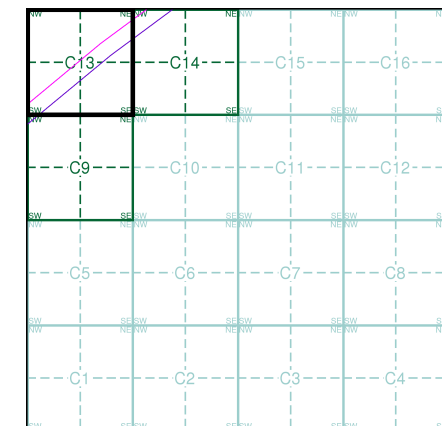

Order Details

Order Number: 201127462_1_1
 Customer Ref: PB8783-103-105
 National Grid Reference: 514690, 456000
 Slice: C
 Site Area (Ha): 2345.09
 Search Buffer (m): 100

Site Details

Hornsea Route

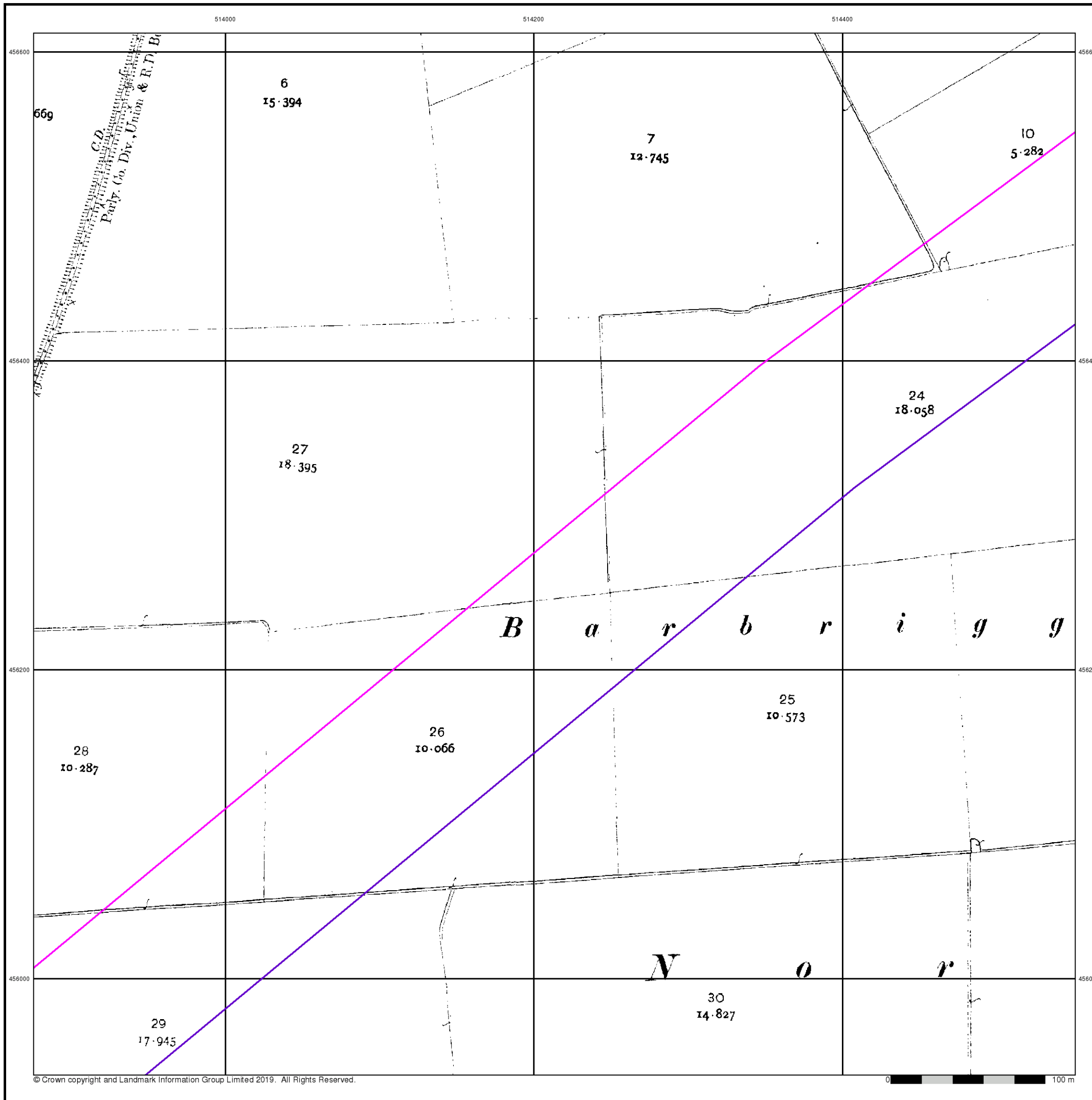

The historical maps shown were reproduced from maps predominantly held at the scale adopted for England, Wales and Scotland in the 1840's. In 1854 the 1:2,500 scale was adopted for mapping urban areas and by 1896 it covered the whole of what were considered to be the cultivated parts of Great Britain. The published date given below is often some years later than the surveyed date. Before 1938, all OS maps were based on the Cassini Projection, with independent surveys of a single county or group of counties, giving rise to significant inaccuracies in outlying areas.

Map Name(s) and Date(s)

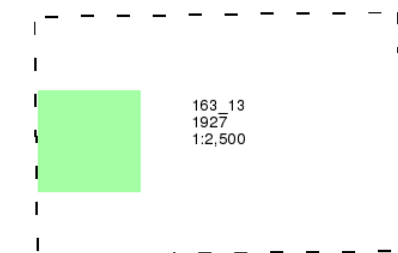

Historical Map - Segment C13

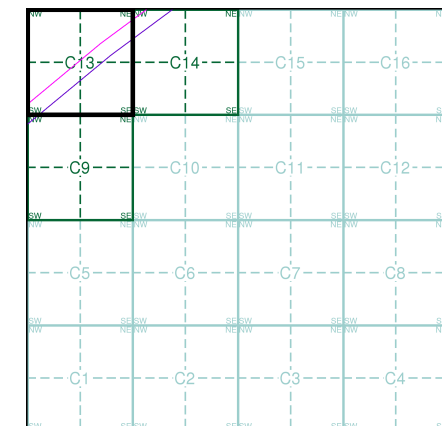

Order Details

Order Number: 201127462_1_1
 Customer Ref: PB8783-103-105
 National Grid Reference: 514690, 456000
 Slice: C
 Site Area (Ha): 2345.09
 Search Buffer (m): 100

Site Details

Hornsea Route

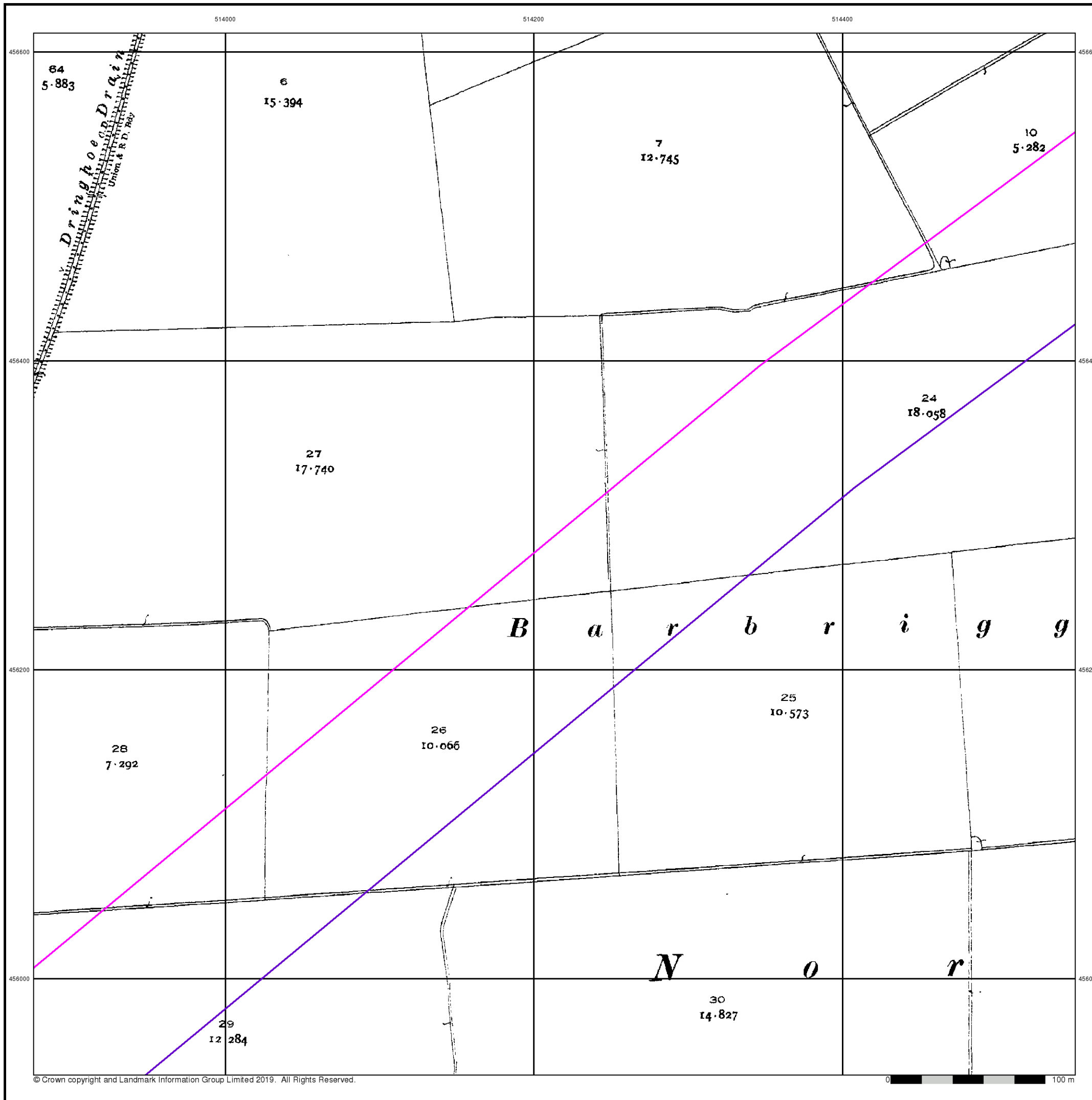

Ordnance Survey Plan

Published 1976

Source map scale - 1:2,500

The historical maps shown were reproduced from maps predominantly held at the scale adopted for England, Wales and Scotland in the 1840's. In 1854 the 1:2,500 scale was adopted for mapping urban areas and by 1896 it covered the whole of what were considered to be the cultivated parts of Great Britain. The published date given below is often some years later than the surveyed date. Before 1938, all OS maps were based on the Cassini Projection, with independent surveys of a single county or group of counties, giving rise to significant inaccuracies in outlying areas.

Map Name(s) and Date(s)

TA1356 1976 12,500	TA1456 1976 12,500
TA1355 1976 12,500	TA1455 1976 12,500

Historical Map - Segment C13

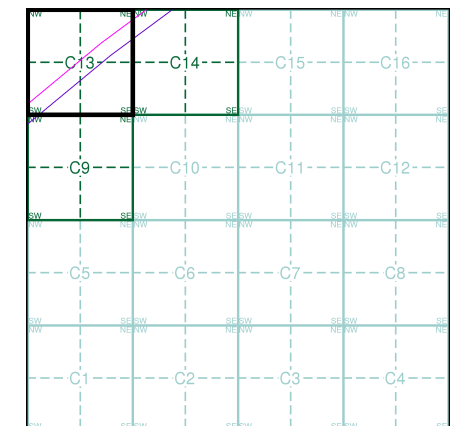

Order Details

Order Number: 201127462_1_1
 Customer Ref: PB8783-103-105
 National Grid Reference: 514690, 456000
 Slice: C
 Site Area (Ha): 2345.09
 Search Buffer (m): 100

Site Details

Hornsea Route

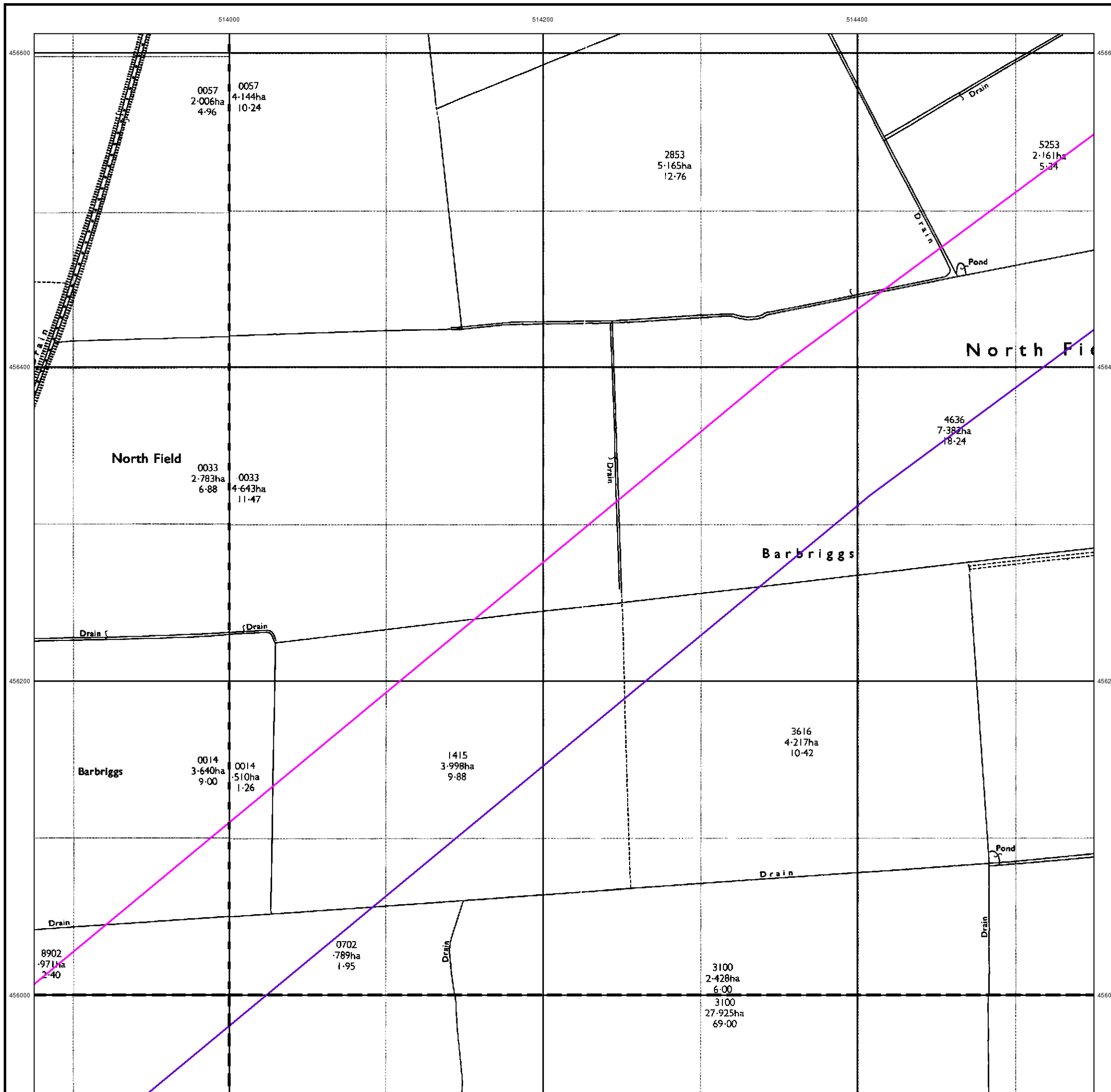

Large-Scale National Grid Data

Published 1995

Source map scale - 1:2,500

'Large Scale National Grid Data' superseded SIM cards (Ordnance Survey's 'Survey of Information on Microfilm') in 1992, and continued to be produced until 1999. These maps were the fore-runners of digital mapping and so provide detailed information on houses and roads, but tend to show less topographic features such as vegetation. These maps were produced at both 1:2,500 and 1:1,250 scales.

Map Name(s) and Date(s)

TA1356 1995 1:2,500	TA1456 1995 1:2,500
TA1355 1995 1:2,500	TA1455 1995 1:2,500

Historical Map - Segment C13

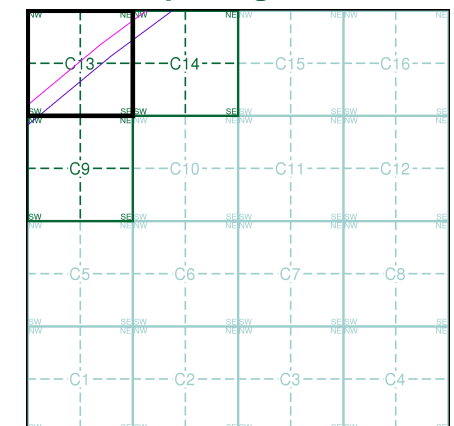

Order Details

Order Number: 201127462_1_1
 Customer Ref: PB8783-103-105
 National Grid Reference: 514690, 456000
 Slice: C
 Site Area (Ha): 2345.09
 Search Buffer (m): 100

Site Details

Hornsea Route

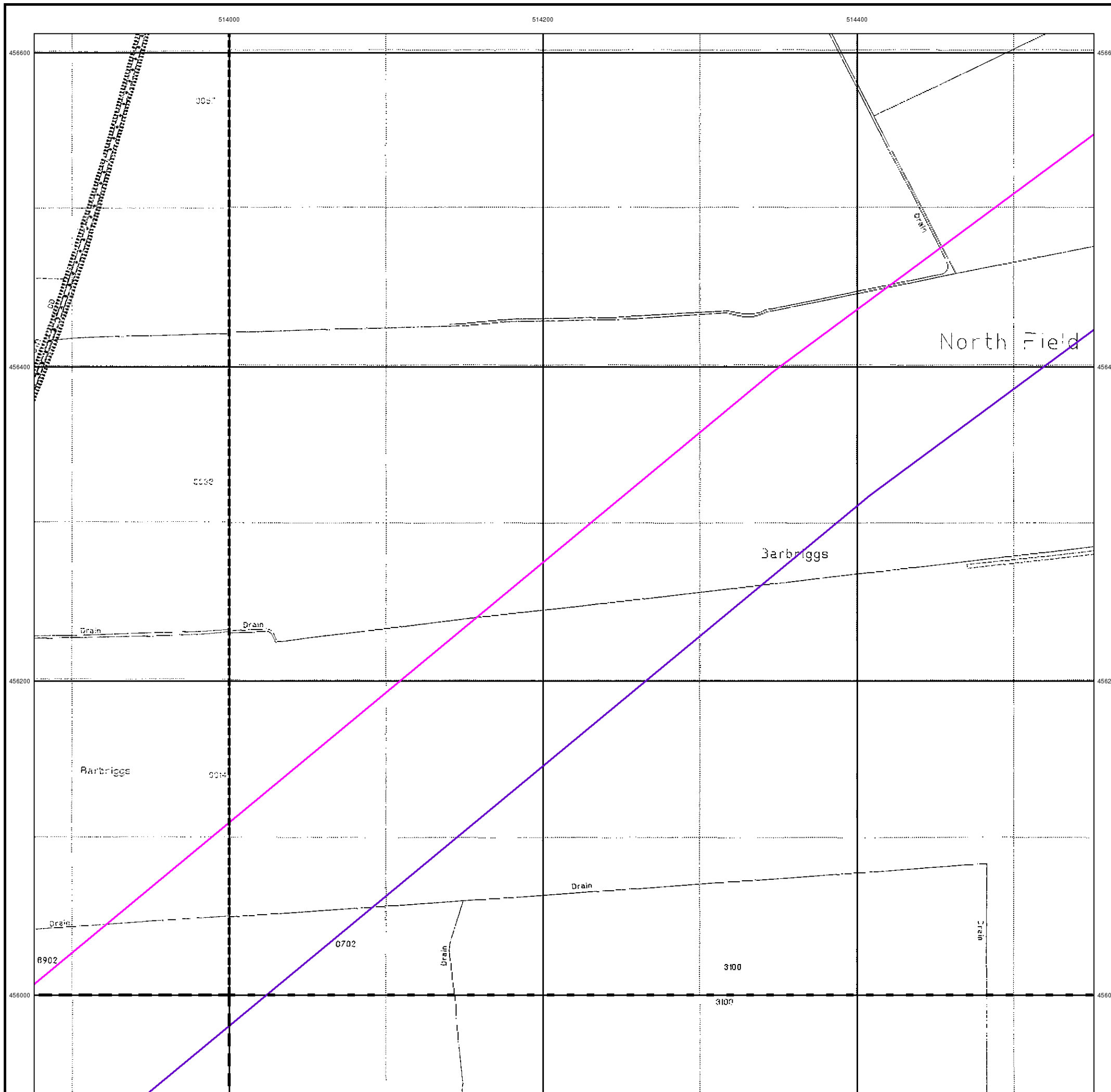

Historical Mapping Legends

Ordnance Survey County Series and Ordnance Survey Plan 1:2,500

Quarry **Gravel Pit** **Sand Pit**
Clay Pit **Shingle** **Refuse Heap**
Sloping Masonry **Flat Rock**
Marsh **Reeds** **Osiers**
Rough Pasture **Furze** **Wood**
Mixed Wood **Brushwood** **Orchard**
Fir **Ford** **Stepping Stones**
Ferry **Waterfall** **Lock**
Trig. Station **Altitude at Trig. Station**
B.M. 325.9 **Bench Mark** **Surface Level**
Arrow denotes flow of water **Antiquities (site of)**
Cutting **Embankment**
Railway crossing Road **Level Crossing** **Road crossing Railway**
Railway crossing River or Canal **Road over single stream** **Road over River or Canal**
County Boundary (Geographical)
County & Civil Parish Boundary
Administrative County & Civil Parish Boundary
County Borough Boundary (England)
Co. Boro. Bdy.
County Burgh Boundary (Scotland)
Boundary Post or Stone **Police Call Box**
B.R. **Bridle Road** **P** **Pump**
E.P. **Electricity Pylon** **S.P.** **Signal Post**
F.B. **Foot Bridge** **Sl.** **Sluice**
F.P. **Foot Path** **Sp.** **Spring**
G.P. **Guide Post or Board** **T.C.B.** **Telephone Call Box**
M.S. **Mile Stone** **Tr.** **Trough**
M.P. M.R. **Mooring Post or Ring** **W** **Well**

Ordnance Survey Plan, Additional SIMs and Supply of Unpublished Survey Information 1:2,500 and 1:1,250

Inactive Quarry, Chalk Pit or Clay Pit **Active Quarry, Chalk Pit or Clay Pit**
Rock **Boulders**
Cliff **Slopes** **Top**
Roofed Building **Glazed Roof Building**
Sloping Masonry **Archway**
Non-Coniferous Tree (surveyed) **Coniferous Tree (surveyed)**
Non-Coniferous Trees (not surveyed) **Coniferous Trees (not surveyed)**
Orchard Tree **Scrub** **Bracken**
Coppice, Osier **Reeds** **Marsh, Saltings**
Rough Grassland **Heath** **Culvert**
Direction of water flow **Bench Mark** **Antiquity (site of)**
Cave Entrance **Triangulation Station** **Electricity Pylon**
Electricity Transmission Line
County Boundary (Geographical)
County & Civil Parish Boundary
Civil Parish Boundary
Admin. County or County Bor. Boundary
London Borough Boundary
Symbol marking point where boundary mereing changes
BH **Beer House** **P** **Pillar, Pole or Post**
BP, BS **Boundary Post or Stone** **PO** **Post Office**
Cn, C **Capstan, Crane** **PC** **Public Convenience**
Chy **Chimney** **PH** **Public House**
D Fn **Drinking Fountain** **Pp** **Pump**
EI P **Electricity Pillar or Post** **SB, S Br** **Signal Box or Bridge**
FAP **Fire Alarm Pillar** **SP, SL** **Signal Post or Light**
FB **Foot Bridge** **Spr** **Spring**
GP **Guide Post** **Tk** **Tank or Track**
H **Hydrant or Hydraulic** **TCB** **Telephone Call Box**
LC **Level Crossing** **TCP** **Telephone Call Post**
MH **Manhole** **Tr** **Trough**
MP **Mile Post or Mooring Post** **Wr Pt, Wr T** **Water Point, Water Tap**
MS **Mile Stone** **W** **Well**
NTL **Normal Tidal Limit** **Wd Pp** **Wind Pump**

Large-Scale National Grid Data 1:2,500 and 1:1,250

Cliff **Slopes** **Top**
Rock **Rock (scattered)**
Boulders **Boulders (scattered)**
Positioned Boulder **Scree**
Non-Coniferous Tree (surveyed) **Coniferous Tree (surveyed)**
Non-Coniferous Trees (not surveyed) **Coniferous Trees (not surveyed)**
Orchard Tree **Scrub** **Bracken**
Coppice, Osier **Reeds** **Marsh, Saltings**
Rough Grassland **Heath** **Culvert**
Direction of water flow **Triangulation Station** **Antiquity (site of)**
Electricity Transmission Line **Electricity Pylon**
B.M. 231.60m **Bench Mark** **Buildings with Building Seed**
Roofed Building **Glazed Roof Building**
Civil parish/community boundary
District boundary
County boundary
Boundary post/stone
Boundary mereing symbol (note: these always appear in opposed pairs or groups of three)
Bks **Barracks** **P** **Pillar, Pole or Post**
Bty **Battery** **PO** **Post Office**
Cemy **Cemetery** **PC** **Public Convenience**
Chy **Chimney** **Pp** **Pump**
Cis **Cistern** **Ppg Sta** **Pumping Station**
Dismtd Rly **Dismantled Railway** **PW** **Place of Worship**
EI Gen Sta **Electricity Generating Station** **Sewage Ppg Sta** **Sewage Pumping Station**
EI P **Electricity Pole, Pillar** **SB, S Br** **Signal Box or Bridge**
EI Sub Sta **Electricity Sub Station** **SP, SL** **Signal Post or Light**
FB **Filter Bed** **Spr** **Spring**
Fn / D Fn **Fountain / Drinking Ftn.** **Tk** **Tank or Track**
Gas Gov **Gas Valve Compound** **Tr** **Trough**
GVC **Gas Governor** **Wd Pp** **Wind Pump**
GP **Guide Post** **Wr Pt, Wr T** **Water Point, Water Tap**
MH **Manhole** **Wks** **Works (building or area)**
MP, MS **Mile Post or Mile Stone** **W** **Well**

Envirocheck

LANDMARK INFORMATION GROUP

Historical Mapping & Photography included:

Mapping Type	Scale	Date	Pg
Yorkshire	1:2,500	1892	2
Yorkshire	1:2,500	1910	3
Yorkshire	1:2,500	1927	4
Ordnance Survey Plan	1:2,500	1976	5
Large-Scale National Grid Data	1:2,500	1995	6

Historical Map - Segment C14

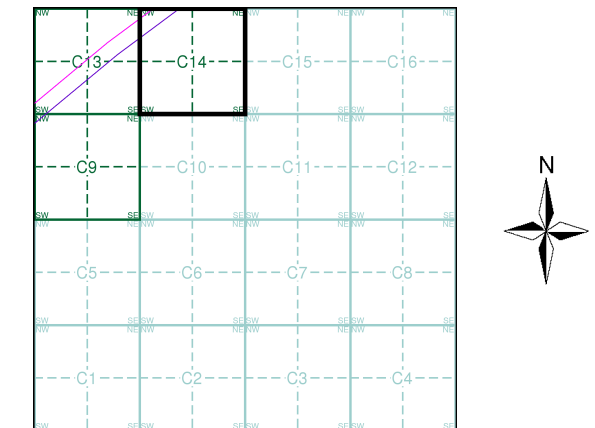

Order Details

Order Number: 201127462_1_1
 Customer Ref: PB8783-103-105
 National Grid Reference: 514690, 456000
 Slice: C
 Site Area (Ha): 2345.09
 Search Buffer (m): 100

Site Details

Hornsea Route

Landmark
 INFORMATION GROUP

Tel: 0844 844 9952
 Fax: 0844 844 9951
 Web: www.envirocheck.co.uk

The historical maps shown were reproduced from maps predominantly held at the scale adopted for England, Wales and Scotland in the 1840's. In 1854 the 1:2,500 scale was adopted for mapping urban areas and by 1896 it covered the whole of what were considered to be the cultivated parts of Great Britain. The published date given below is often some years later than the surveyed date. Before 1938, all OS maps were based on the Cassini Projection, with independent surveys of a single county or group of counties, giving rise to significant inaccuracies in outlying areas.

Map Name(s) and Date(s)

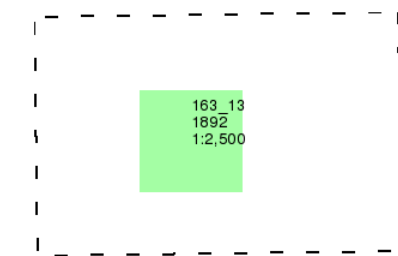

Historical Map - Segment C14

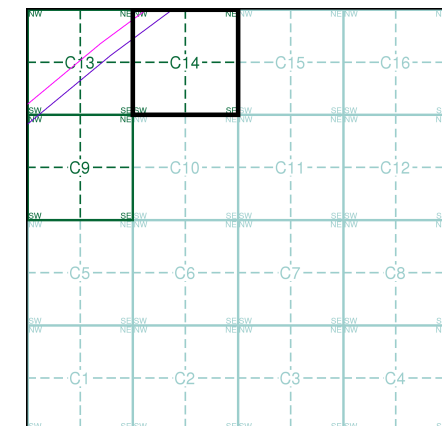

Order Details

Order Number: 201127462_1_1
 Customer Ref: PB8783-103-105
 National Grid Reference: 514690, 456000
 Slice: C
 Site Area (Ha): 2345.09
 Search Buffer (m): 100

Site Details

Hornsea Route

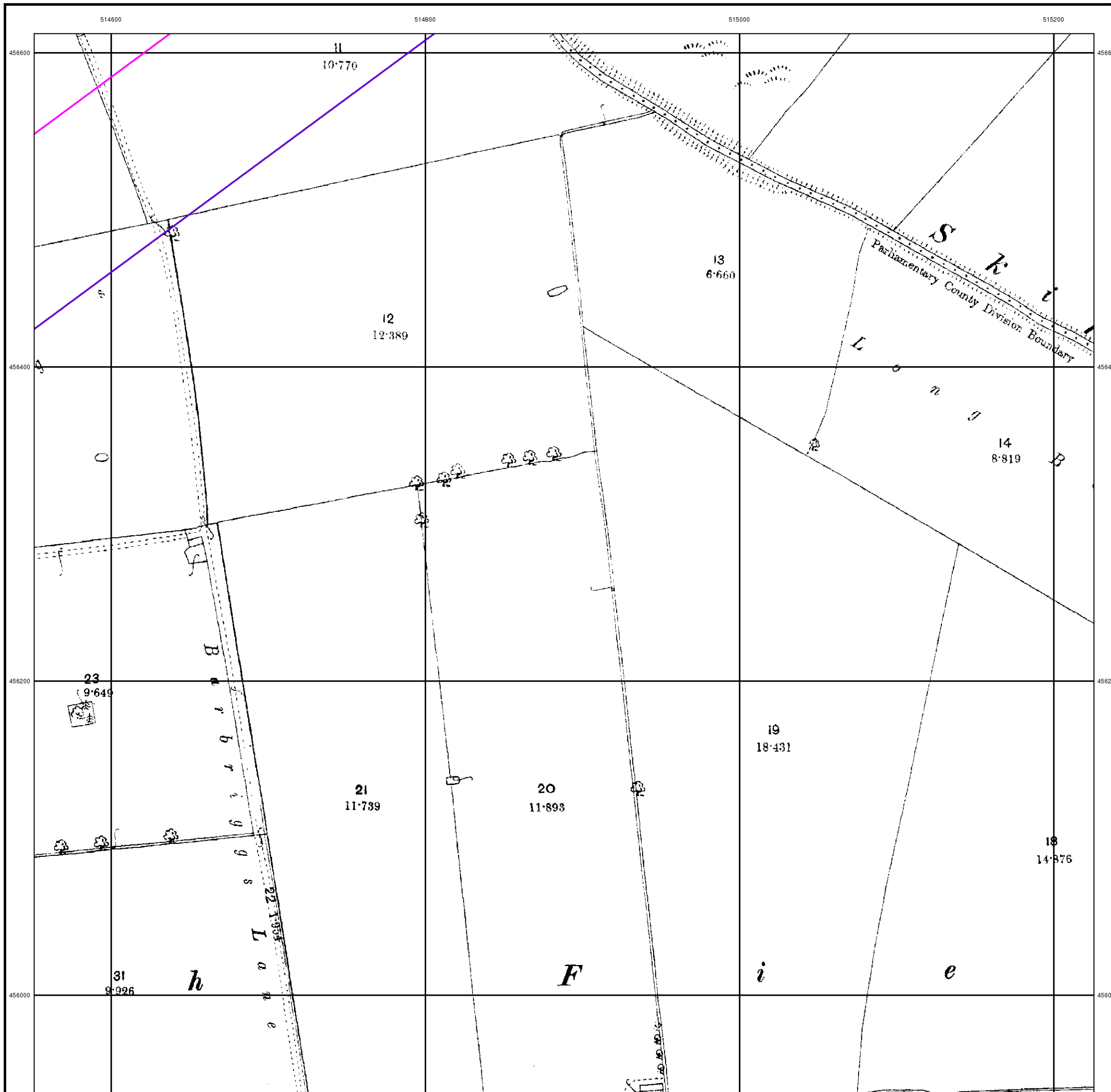

The historical maps shown were reproduced from maps predominantly held at the scale adopted for England, Wales and Scotland in the 1840's. In 1854 the 1:2,500 scale was adopted for mapping urban areas and by 1896 it covered the whole of what were considered to be the cultivated parts of Great Britain. The published date given below is often some years later than the surveyed date. Before 1938, all OS maps were based on the Cassini Projection, with independent surveys of a single county or group of counties, giving rise to significant inaccuracies in outlying areas.

Map Name(s) and Date(s)

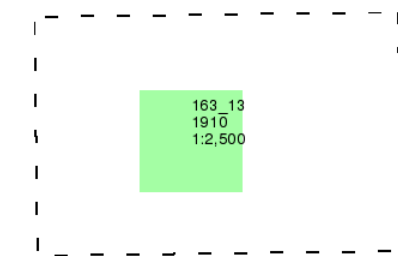

Historical Map - Segment C14

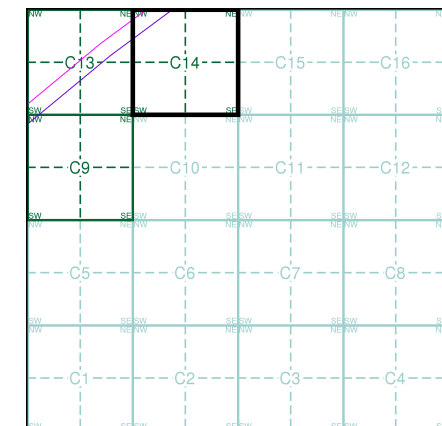

Order Details

Order Number: 201127462_1_1
 Customer Ref: PB8783-103-105
 National Grid Reference: 514690, 456000
 Slice: C
 Site Area (Ha): 2345.09
 Search Buffer (m): 100

Site Details

Hornsea Route

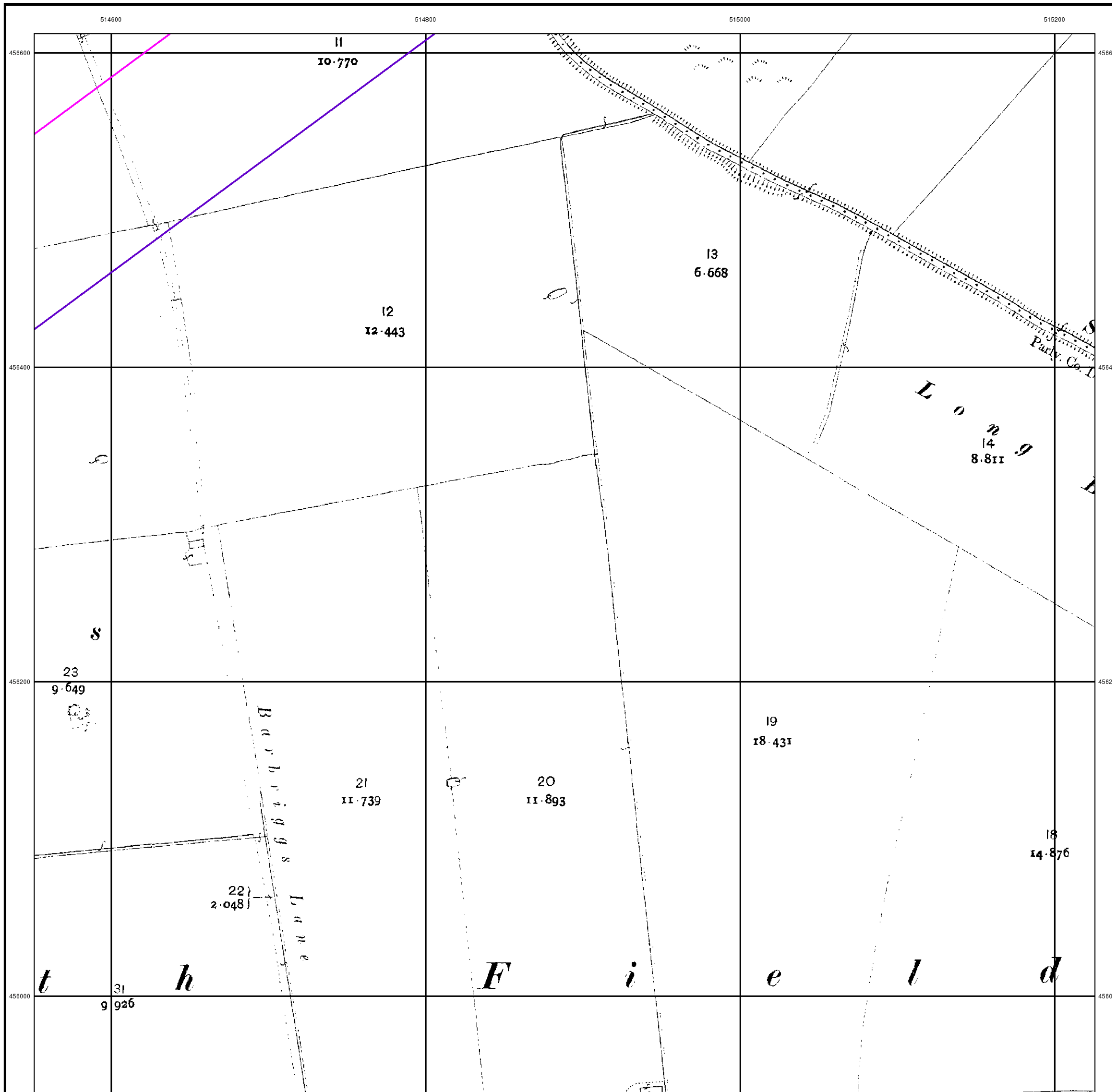

The historical maps shown were reproduced from maps predominantly held at the scale adopted for England, Wales and Scotland in the 1840's. In 1854 the 1:2,500 scale was adopted for mapping urban areas and by 1896 it covered the whole of what were considered to be the cultivated parts of Great Britain. The published date given below is often some years later than the surveyed date. Before 1938, all OS maps were based on the Cassini Projection, with independent surveys of a single county or group of counties, giving rise to significant inaccuracies in outlying areas.

Map Name(s) and Date(s)

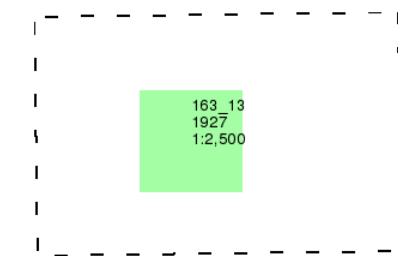

Historical Map - Segment C14

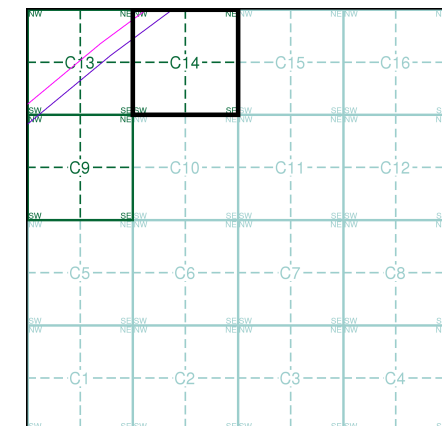

Order Details

Order Number: 201127462_1_1
Customer Ref: PB8783-103-105
National Grid Reference: 514690, 456000
Slice: C
Site Area (Ha): 2345.09
Search Buffer (m): 100

Site Details

Hornsea Route

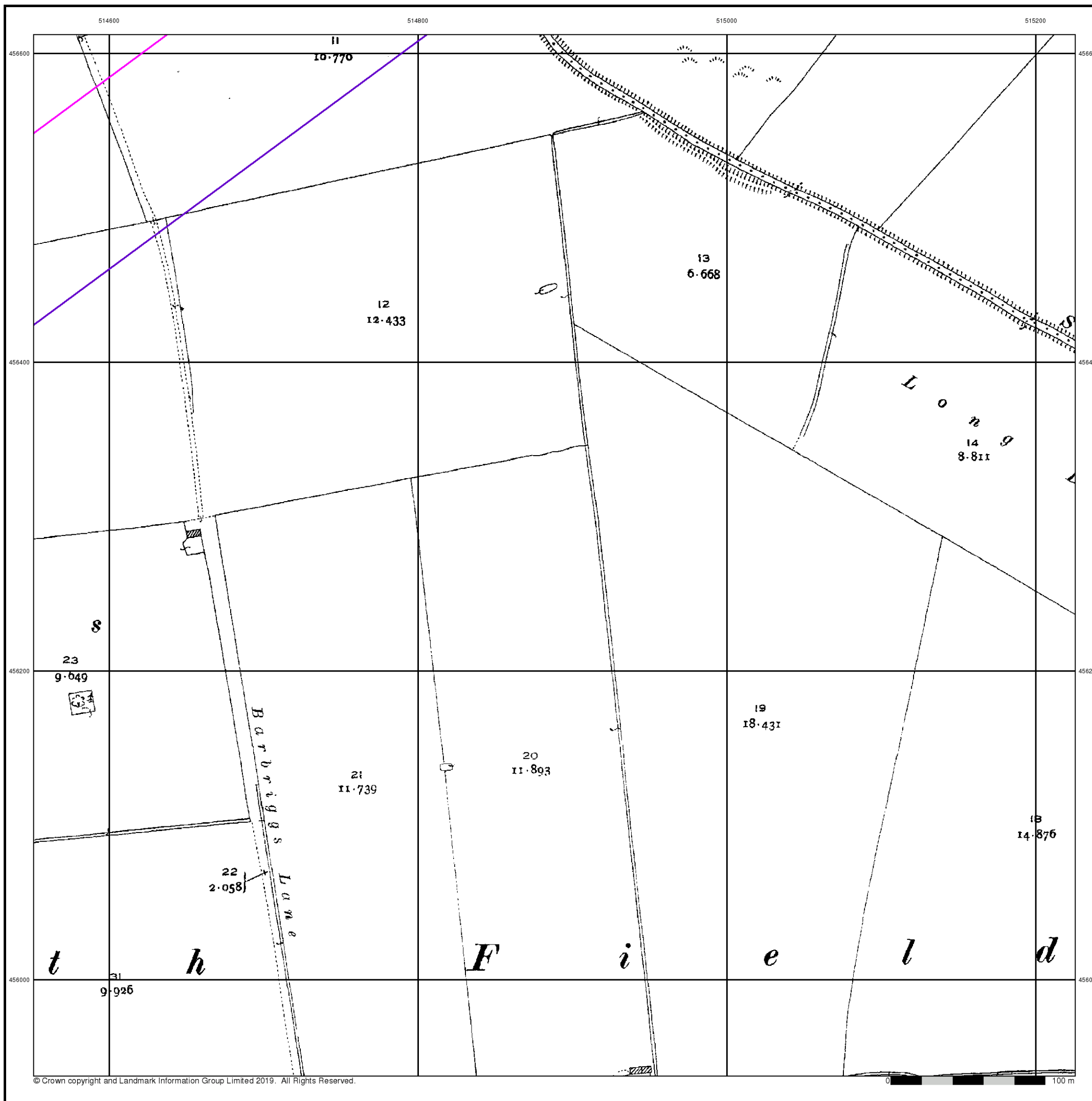

Ordnance Survey Plan

Published 1976

Source map scale - 1:2,500

The historical maps shown were reproduced from maps predominantly held at the scale adopted for England, Wales and Scotland in the 1840's. In 1854 the 1:2,500 scale was adopted for mapping urban areas and by 1896 it covered the whole of what were considered to be the cultivated parts of Great Britain. The published date given below is often some years later than the surveyed date. Before 1938, all OS maps were based on the Cassini Projection, with independent surveys of a single county or group of counties, giving rise to significant inaccuracies in outlying areas.

Map Name(s) and Date(s)

TA1456 1976 12,500	TA1556 1976 12,500
TA1455 1976 12,500	TA1555 1976 12,500

Historical Map - Segment C14

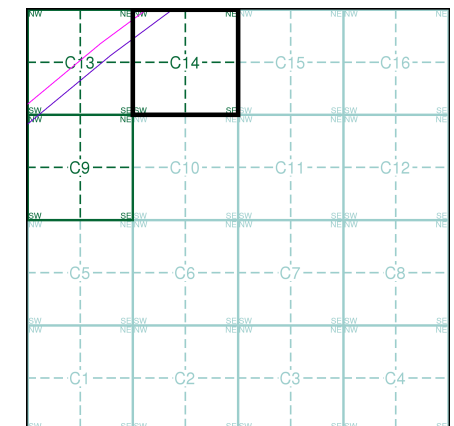

Order Details

Order Number: 201127462_1_1
 Customer Ref: PB8783-103-105
 National Grid Reference: 514690, 456000
 Slice: C
 Site Area (Ha): 2345.09
 Search Buffer (m): 100

Site Details

Hornsea Route

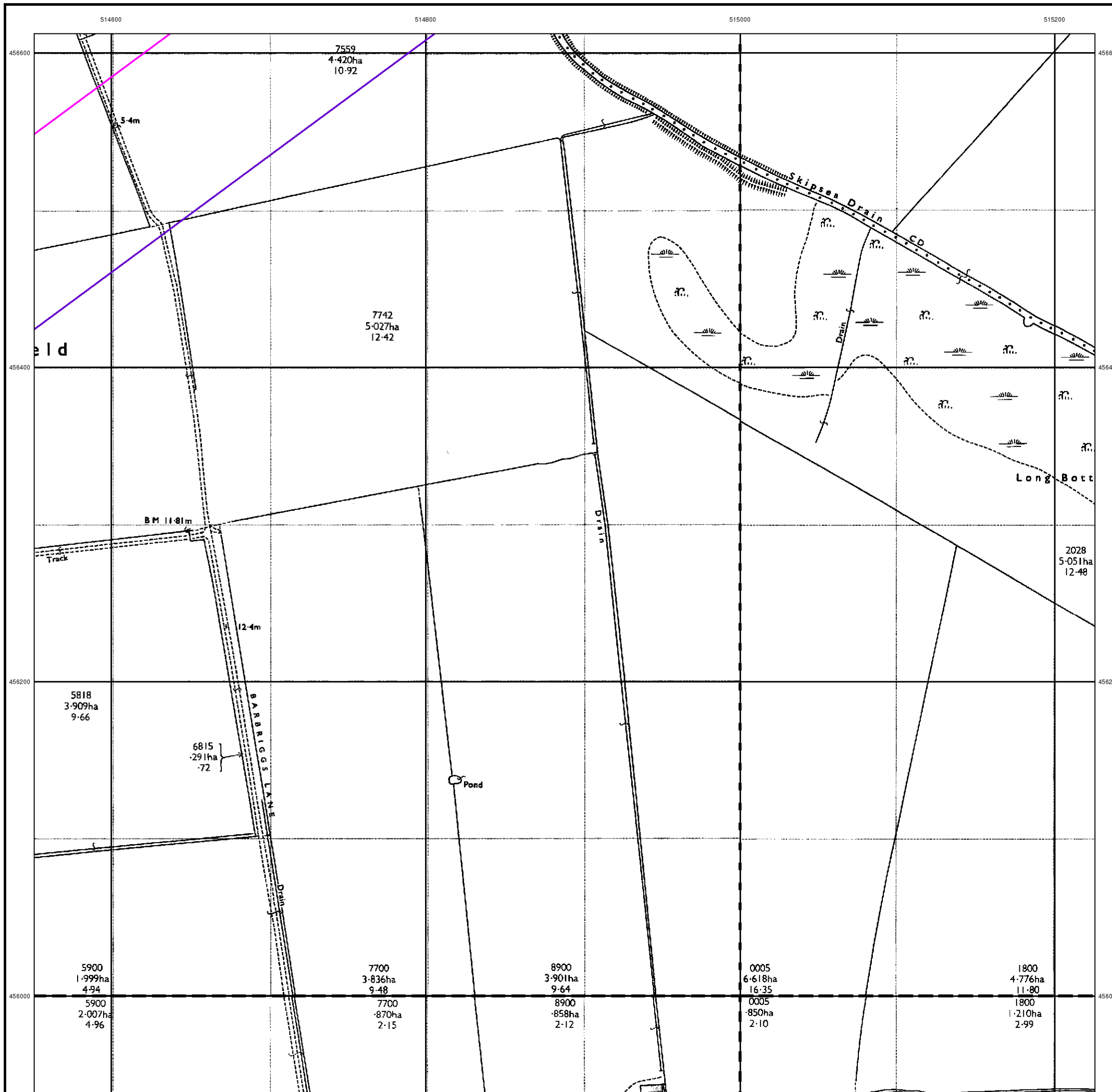

Large-Scale National Grid Data

Published 1995

Source map scale - 1:2,500

'Large Scale National Grid Data' superseded SIM cards (Ordnance Survey's 'Survey of Information on Microfilm') in 1992, and continued to be produced until 1999. These maps were the fore-runners of digital mapping and so provide detailed information on houses and roads, but tend to show less topographic features such as vegetation. These maps were produced at both 1:2,500 and 1:1,250 scales.

Map Name(s) and Date(s)

TA1456 1995 1:2,500	TA1556 1995 1:2,500
TA1455 1995 1:2,500	TA1555 1995 1:2,500

Historical Map - Segment C14

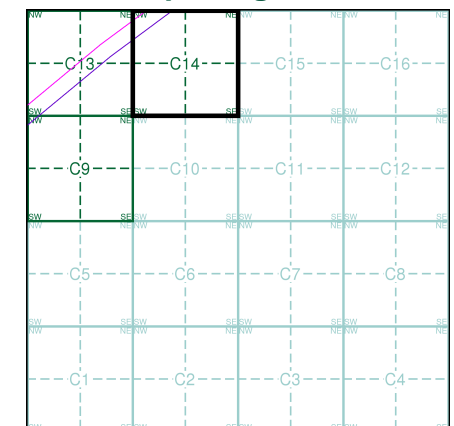

Order Details

Order Number: 201127462_1_1
 Customer Ref: PB8783-103-105
 National Grid Reference: 514690, 456000
 Slice: C
 Site Area (Ha): 2345.09
 Search Buffer (m): 100

Site Details

Hornsea Route

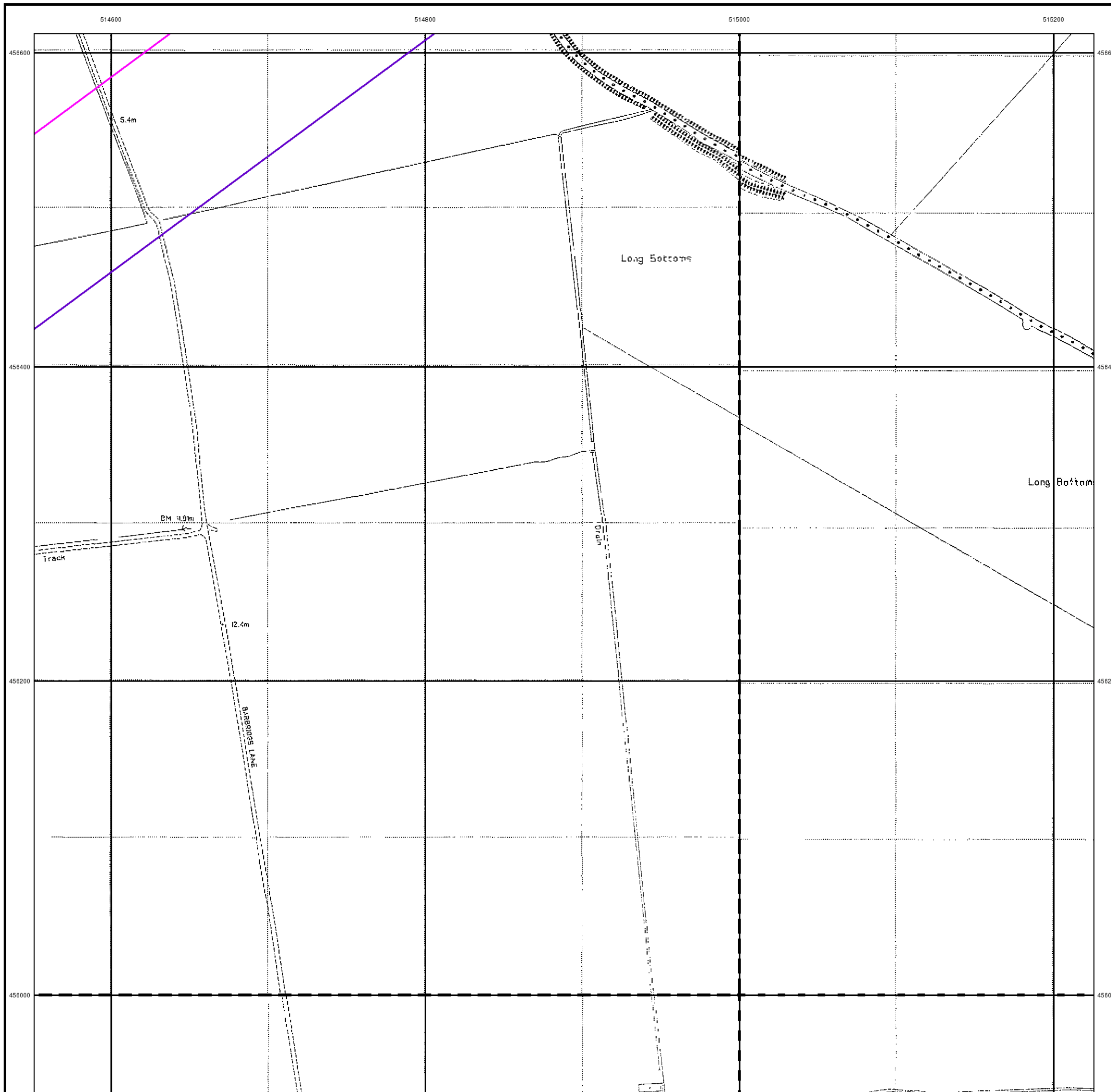

Historical Mapping Legends

Ordnance Survey County Series and Ordnance Survey Plan 1:2,500

Quarry **Gravel Pit** **Sand Pit**
Clay Pit **Shingle** **Refuse Heap**
Sloping Masonry **Flat Rock**
Marsh **Reeds** **Osiers**
Rough Pasture **Furze** **Wood**
Mixed Wood **Brushwood** **Orchard**
Fir **Ford** **Stepping Stones**
Ferry **Waterfall** **Lock**
Trig. Station **Altitude at Trig. Station**
B.M. 325.9 **Bench Mark** **Surface Level**
Arrow denotes flow of water **Antiquities (site of)**
Cutting **Embankment**
Railway crossing Road **Level Crossing** **Road crossing Railway**
Railway crossing River or Canal **Road over single stream** **Road over River or Canal**
County Boundary (Geographical)
County & Civil Parish Boundary
Administrative County & Civil Parish Boundary
County Borough Boundary (England)
County Burgh Boundary (Scotland)
Co. Boro. Bdy.
Co. Burgh Bdy.
BP BS Boundary Post or Stone **P.C.B** Police Call Box
B.R. Bridle Road **P** Pump
E.P Electricity Pylon **S.P** Signal Post
F.B. Foot Bridge **SL** Sluice
F.P. Foot Path **Sp.** Spring
G.P Guide Post or Board **T.C.B** Telephone Call Box
M.S Mile Stone **Tr.** Trough
M.P M.R Mooring Post or Ring **W** Well

Ordnance Survey Plan, Additional SIMs and Supply of Unpublished Survey Information 1:2,500 and 1:1,250

Inactive Quarry, Chalk Pit or Clay Pit **Active Quarry, Chalk Pit or Clay Pit**
Rock **Boulders**
Cliff **Slopes** **Top**
Roofed Building **Glazed Roof Building**
Sloping Masonry **Archway**
Non-Coniferous Tree (surveyed) **Coniferous Tree (surveyed)**
Non-Coniferous Trees (not surveyed) **Coniferous Trees (not surveyed)**
Orchard Tree **Scrub** **Bracken**
Coppice, Osier **Reeds** **Marsh, Saltings**
Rough Grassland **Heath** **Culvert**
Direction of water flow **Bench Mark** **Antiquity (site of)**
Cave Entrance **Triangulation Station** **Electricity Pylon**
Electricity Transmission Line
County Boundary (Geographical)
County & Civil Parish Boundary
Civil Parish Boundary
Admin. County or County Bor. Boundary
London Borough Boundary
Symbol marking point where boundary mereing changes
BH Beer House **P** Pillar, Pole or Post
BP, BS Boundary Post or Stone **PO** Post Office
Cn, C Capstan, Crane **PC** Public Convenience
Chy Chimney **PH** Public House
D Fn Drinking Fountain **Pp** Pump
EI P Electricity Pillar or Post **SB, S Br** Signal Box or Bridge
FAP Fire Alarm Pillar **SP, SL** Signal Post or Light
FB Foot Bridge **Spr** Spring
GP Guide Post **Tk** Tank or Track
H Hydrant or Hydraulic **TCB** Telephone Call Box
LC Level Crossing **TCP** Telephone Call Post
MH Manhole **Tr** Trough
MP Mile Post or Mooring Post **Wr Pt, Wr T** Water Point, Water Tap
MS Mile Stone **W** Well
NTL Normal Tidal Limit **Wd Pp** Wind Pump

Large-Scale National Grid Data 1:2,500 and 1:1,250

Cliff **Slopes** **Top**
Rock **Rock (scattered)**
Boulders **Boulders (scattered)**
Positioned Boulder **Scree**
Non-Coniferous Tree (surveyed) **Coniferous Tree (surveyed)**
Non-Coniferous Trees (not surveyed) **Coniferous Trees (not surveyed)**
Orchard Tree **Scrub** **Bracken**
Coppice, Osier **Reeds** **Marsh, Saltings**
Rough Grassland **Heath** **Culvert**
Direction of water flow **Triangulation Station** **Antiquity (site of)**
Electricity Transmission Line **Electricity Pylon**
Bench Mark **Buildings with Building Seed**
Roofed Building **Glazed Roof Building**
Civil parish/community boundary
District boundary
County boundary
Boundary post/stone
Boundary mereing symbol (note: these always appear in opposed pairs or groups of three)
Bks Barracks **P** Pillar, Pole or Post
Bty Battery **PO** Post Office
Cemy Cemetery **PC** Public Convenience
Chy Chimney **Pp** Pump
Cis Cistern **Ppg Sta** Pumping Station
Dismtd Rly Dismantled Railway **PW** Place of Worship
EI Gen Sta Electricity Generating Station **Sewage Ppg Sta** Sewage Pumping Station
EI P Electricity Pole, Pillar **SB, S Br** Signal Box or Bridge
EI Sub Sta Electricity Sub Station **SP, SL** Signal Post or Light
FB Filter Bed **Spr** Spring
Fn / D Fn Fountain / Drinking Ftn. **Tk** Tank or Track
Gas Gov Gas Valve Compound **Tr** Trough
GVC Gas Governor **Wd Pp** Wind Pump
GP Guide Post **Wr Pt, Wr T** Water Point, Water Tap
MH Manhole **Wks** Works (building or area)
MP, MS Mile Post or Mile Stone **W** Well

Envirocheck

LANDMARK INFORMATION GROUP

Historical Mapping & Photography included:

Mapping Type	Scale	Date	Pg
Yorkshire	1:2,500	1892	2
Yorkshire	1:2,500	1910	3
Ordnance Survey Plan	1:2,500	1976	4
Large-Scale National Grid Data	1:2,500	1995	5

Historical Map - Segment C15

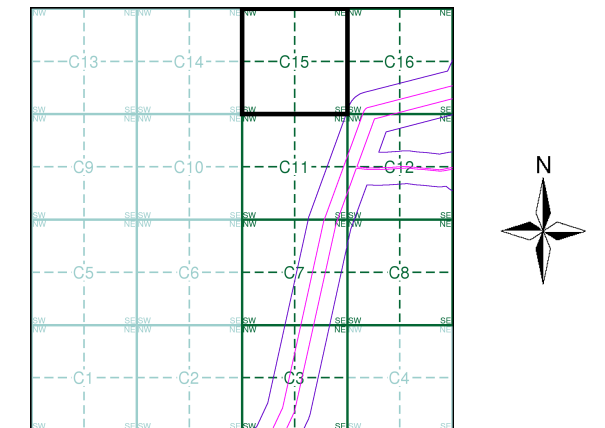

Order Details

Order Number: 201127465_1_1
 Customer Ref: PB8783-103-105
 National Grid Reference: 506560, 453280
 Slice: C
 Site Area (Ha): 72.
 Search Buffer (m): 100

Site Details

Hornsea Route

Landmark
 INFORMATION GROUP

Tel: 0844 844 9952
 Fax: 0844 844 9951
 Web: www.envirocheck.co.uk

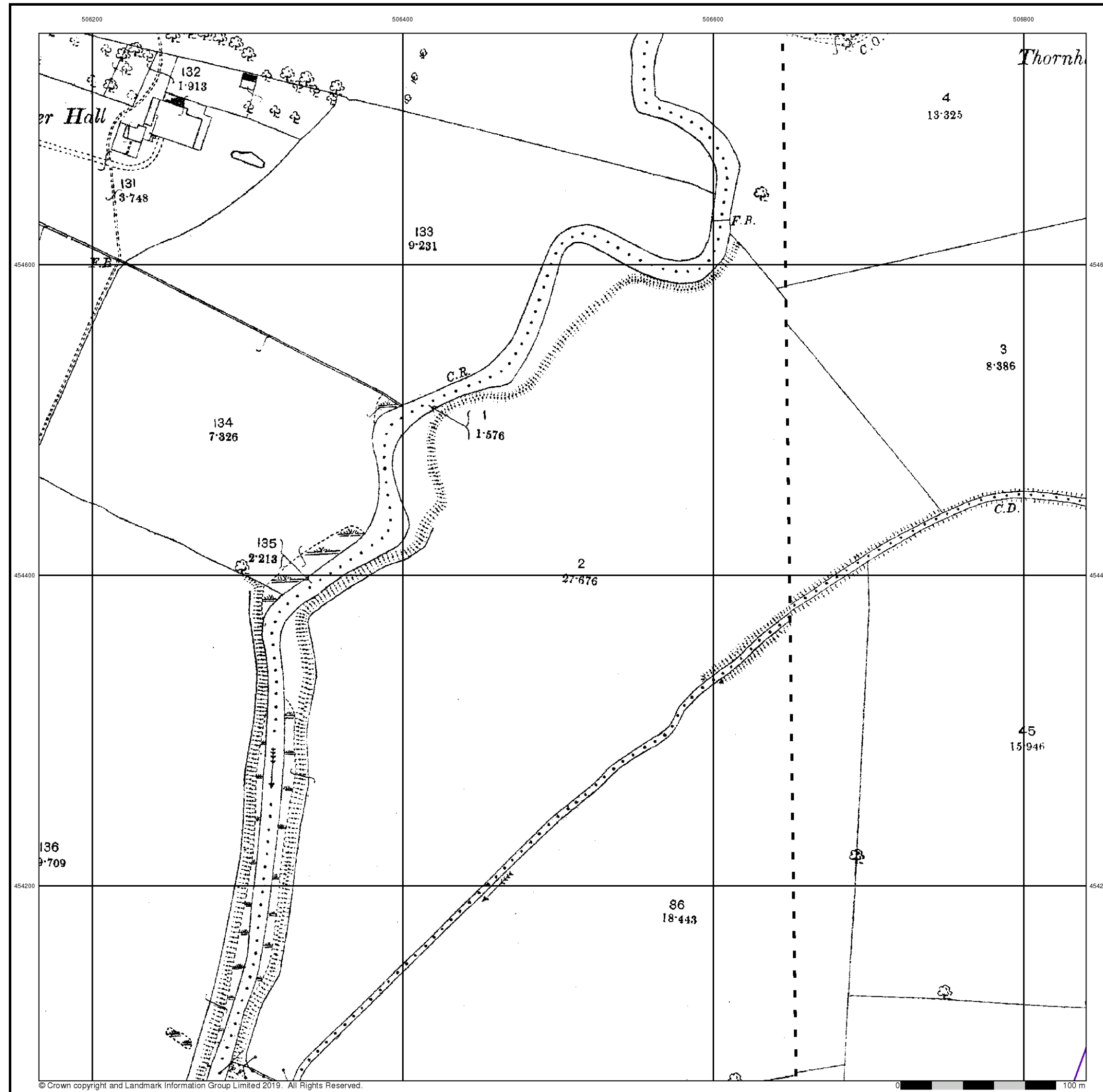

Envirocheck®

LANDMARK INFORMATION GROUP®

Yorkshire

Published 1892

Source map scale - 1:2,500

The historical maps shown were reproduced from maps predominantly held at the scale adopted for England, Wales and Scotland in the 1840's. In 1854 the 1:2,500 scale was adopted for mapping urban areas and by 1896 it covered the whole of what were considered to be the cultivated parts of Great Britain. The published date given below is often some years later than the surveyed date. Before 1938, all OS maps were based on the Cassini Projection, with independent surveys of a single county or group of counties, giving rise to significant inaccuracies in outlying areas.

Map Name(s) and Date(s)

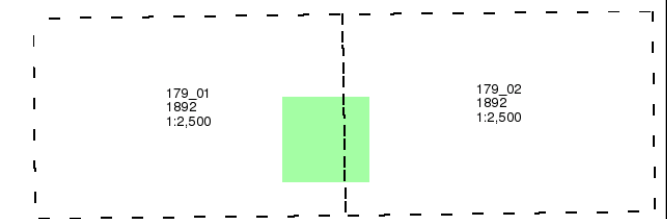

Historical Map - Segment C15

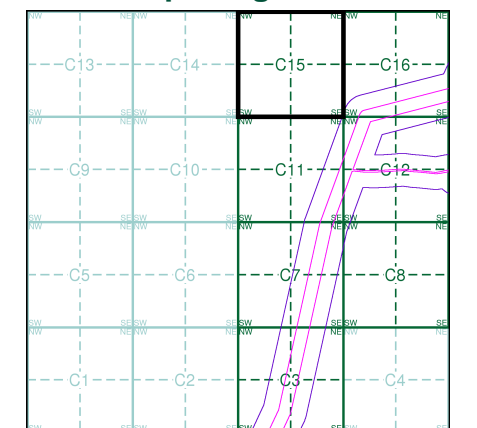

Order Details

Order Number: 201127465_1_1
 Customer Ref: PB8783-103-105
 National Grid Reference: 506560, 453280
 Slice: C
 Site Area (Ha): 72.
 Search Buffer (m): 100

Site Details

Hornsea Route

Landmark
 INFORMATION GROUP

Tel: 0844 844 9952
 Fax: 0844 844 9951
 Web: www.envirocheck.co.uk

The historical maps shown were reproduced from maps predominantly held at the scale adopted for England, Wales and Scotland in the 1840's. In 1854 the 1:2,500 scale was adopted for mapping urban areas and by 1896 it covered the whole of what were considered to be the cultivated parts of Great Britain. The published date given below is often some years later than the surveyed date. Before 1938, all OS maps were based on the Cassini Projection, with independent surveys of a single county or group of counties, giving rise to significant inaccuracies in outlying areas.

Map Name(s) and Date(s)

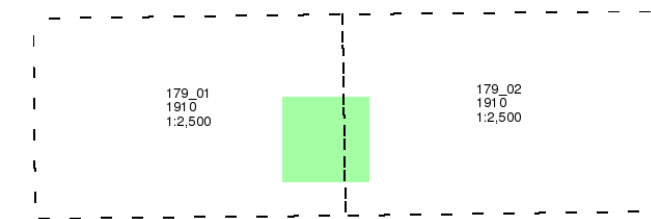

Historical Map - Segment C15

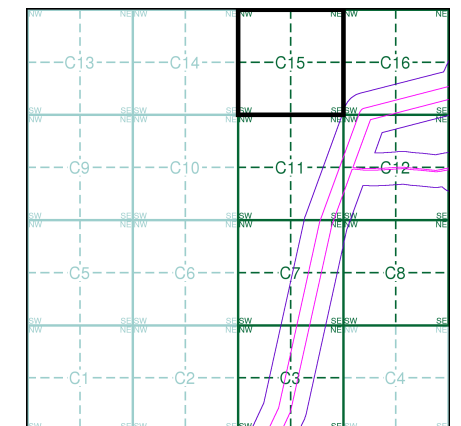

Order Details

Order Number: 201127465_1_1
 Customer Ref: PB8783-103-105
 National Grid Reference: 506560, 453280
 Slice: C
 Site Area (Ha): 72.
 Search Buffer (m): 100

Site Details

Hornsea Route

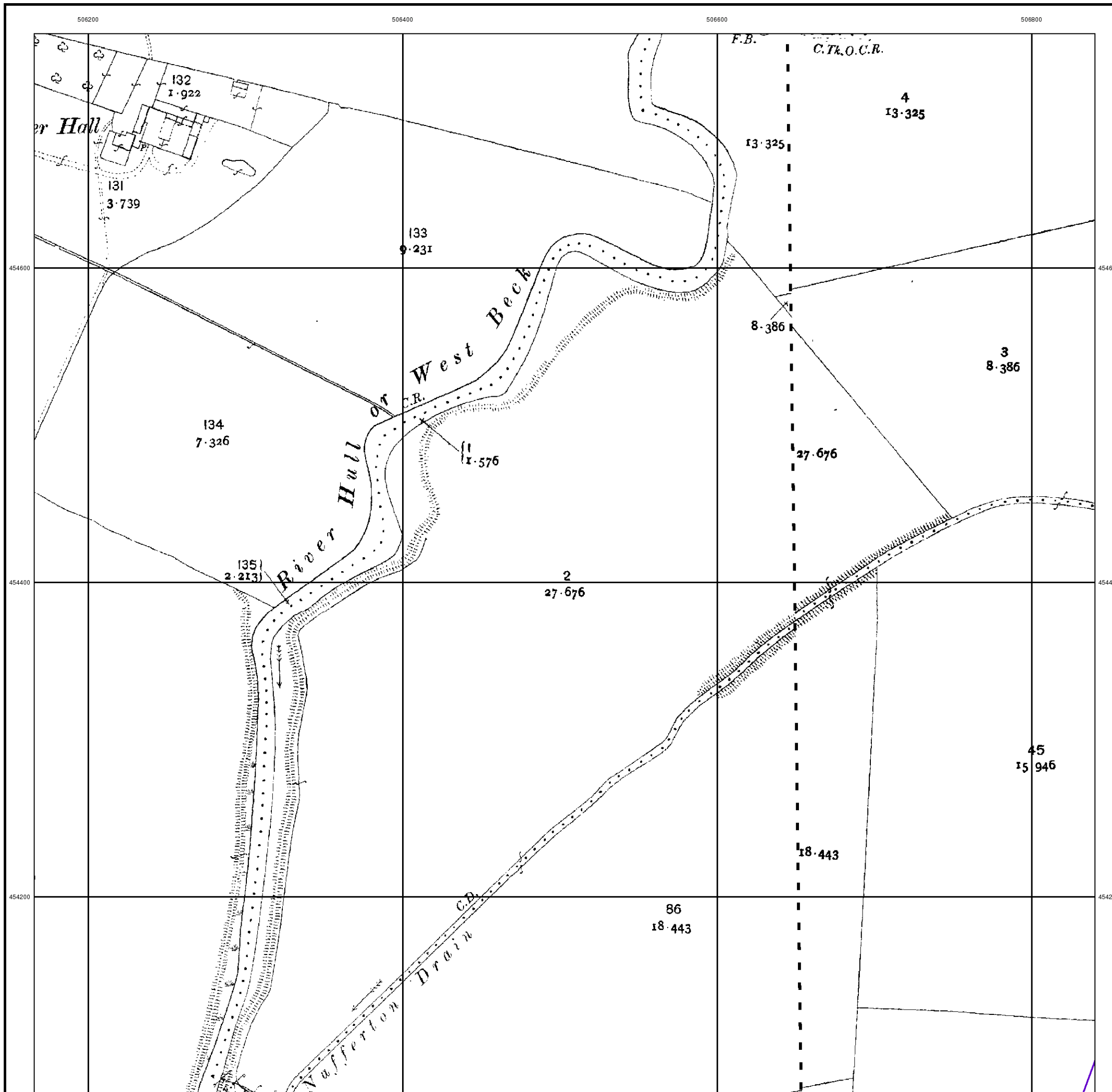

Ordnance Survey Plan

Published 1976

Source map scale - 1:2,500

The historical maps shown were reproduced from maps predominantly held at the scale adopted for England, Wales and Scotland in the 1840's. In 1854 the 1:2,500 scale was adopted for mapping urban areas and by 1896 it covered the whole of what were considered to be the cultivated parts of Great Britain. The published date given below is often some years later than the surveyed date. Before 1938, all OS maps were based on the Cassini Projection, with independent surveys of a single county or group of counties, giving rise to significant inaccuracies in outlying areas.

Map Name(s) and Date(s)

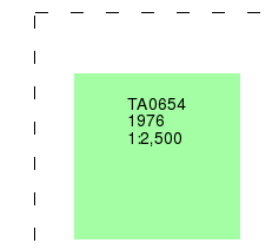

Historical Map - Segment C15

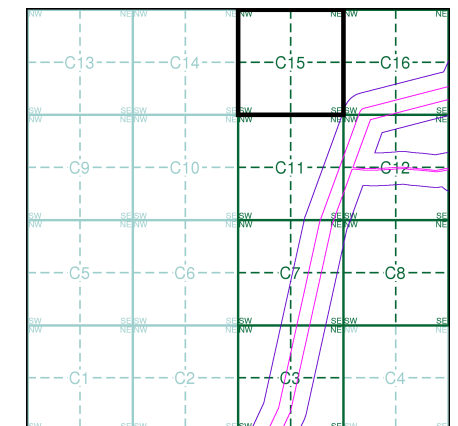

Order Details

Order Number: 201127465_1_1
 Customer Ref: PB8783-103-105
 National Grid Reference: 506560, 453280
 Slice: C
 Site Area (Ha): 72.
 Search Buffer (m): 100

Site Details

Hornsea Route

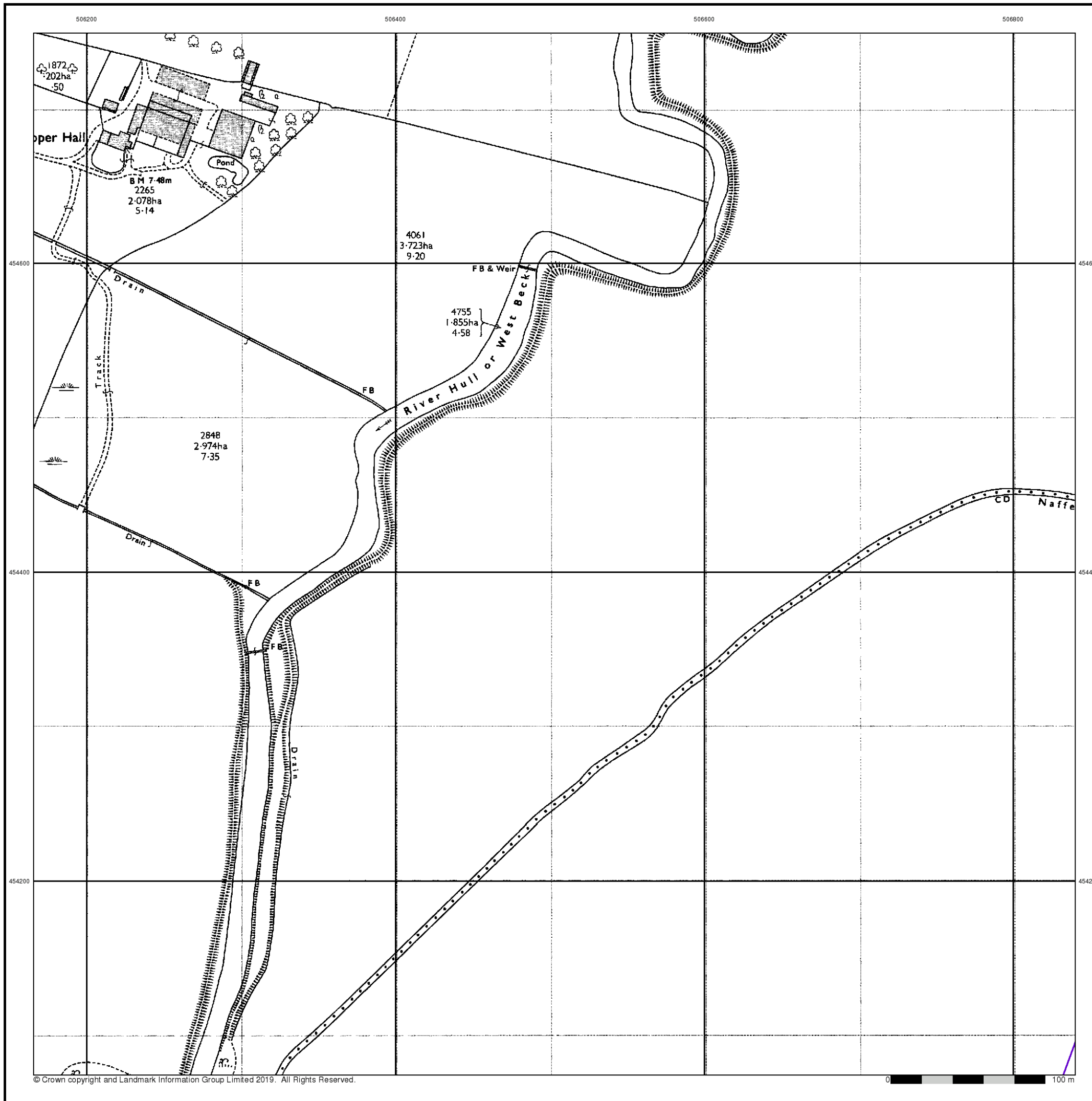

Large-Scale National Grid Data

Published 1995

Source map scale - 1:2,500

'Large Scale National Grid Data' superseded SIM cards (Ordnance Survey's 'Survey of Information on Microfilm') in 1992, and continued to be produced until 1999. These maps were the fore-runners of digital mapping and so provide detailed information on houses and roads, but tend to show less topographic features such as vegetation. These maps were produced at both 1:2,500 and 1:1,250 scales.

Map Name(s) and Date(s)

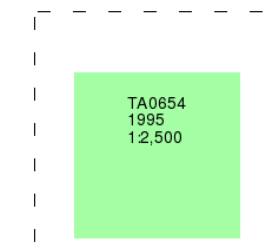

Historical Map - Segment C15

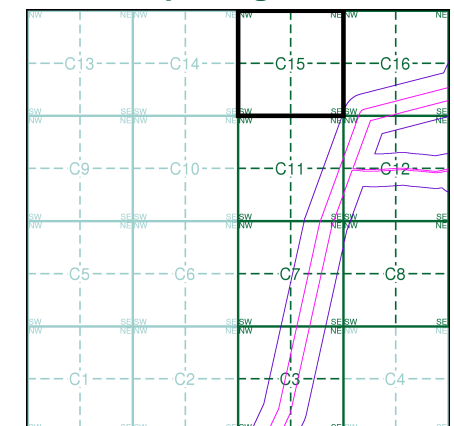

Order Details

Order Number: 201127465_1_1
Customer Ref: PB8783-103-105
National Grid Reference: 506560, 453280
Slice: C
Site Area (Ha): 72.
Search Buffer (m): 100

Site Details

Hornsea Route



Historical Mapping Legends

Ordnance Survey County Series and Ordnance Survey Plan 1:2,500

Quarry **Gravel Pit** **Sand Pit**
Clay Pit **Shingle** **Refuse Heap**
Sloping Masonry **Flat Rock**
Marsh **Reeds** **Osiers**
Rough Pasture **Furze** **Wood**
Mixed Wood **Brushwood** **Orchard**
Fir **Ford** **Stepping Stones**
Ferry **Waterfall** **Lock**
Trig. Station **Altitude at Trig. Station**
B.M. 325.9 **Bench Mark** **Surface Level**
Arrow denotes flow of water **Antiquities (site of)**
Cutting **Embankment**
Railway crossing Road **Level Crossing** **Road crossing Railway**
Railway crossing River or Canal **Road over single stream** **Road over River or Canal**
County Boundary (Geographical)
County & Civil Parish Boundary
Administrative County & Civil Parish Boundary
County Borough Boundary (England)
County Burgh Boundary (Scotland)
Co. Boro. Bdy.
Co. Burgh Bdy.
BP BS Boundary Post or Stone **P.C.B** Police Call Box
B.R. Bridle Road **P** Pump
E.P Electricity Pylon **S.P** Signal Post
F.B. Foot Bridge **SL** Sluice
F.P. Foot Path **Sp.** Spring
G.P Guide Post or Board **T.C.B** Telephone Call Box
M.S Mile Stone **Tr.** Trough
M.P M.R Mooring Post or Ring **W** Well

Ordnance Survey Plan, Additional SIMs and Supply of Unpublished Survey Information 1:2,500 and 1:1,250

Inactive Quarry, Chalk Pit or Clay Pit **Active Quarry, Chalk Pit or Clay Pit**
Rock **Boulders**
Cliff **Slopes** **Top**
Roofed Building **Glazed Roof Building**
Sloping Masonry **Archway**
Non-Coniferous Tree (surveyed) **Coniferous Tree (surveyed)**
Non-Coniferous Trees (not surveyed) **Coniferous Trees (not surveyed)**
Orchard Tree **Scrub** **Bracken**
Coppice, Osier **Reeds** **Marsh, Saltings**
Rough Grassland **Heath** **Culvert**
Direction of water flow **Bench Mark** **Antiquity (site of)**
Cave Entrance **Triangulation Station** **Electricity Pylon**
Electricity Transmission Line
County Boundary (Geographical)
County & Civil Parish Boundary
Civil Parish Boundary
Admin. County or County Bor. Boundary
London Borough Boundary
Symbol marking point where boundary mereing changes
BH Beer House **P** Pillar, Pole or Post
BP, BS Boundary Post or Stone **PO** Post Office
Cn, C Capstan, Crane **PC** Public Convenience
Chy Chimney **PH** Public House
D Fn Drinking Fountain **Pp** Pump
EI P Electricity Pillar or Post **SB, S Br** Signal Box or Bridge
FAP Fire Alarm Pillar **SP, SL** Signal Post or Light
FB Foot Bridge **Spr** Spring
GP Guide Post **Tk** Tank or Track
H Hydrant or Hydraulic **TCB** Telephone Call Box
LC Level Crossing **TCP** Telephone Call Post
MH Manhole **Tr** Trough
MP Mile Post or Mooring Post **Wr Pt, Wr T** Water Point, Water Tap
MS Mile Stone **W** Well
NTL Normal Tidal Limit **Wd Pp** Wind Pump

Large-Scale National Grid Data 1:2,500 and 1:1,250

Cliff **Slopes** **Top**
Rock **Rock (scattered)**
Boulders **Boulders (scattered)**
Positioned Boulder **Scree**
Non-Coniferous Tree (surveyed) **Coniferous Tree (surveyed)**
Non-Coniferous Trees (not surveyed) **Coniferous Trees (not surveyed)**
Orchard Tree **Scrub** **Bracken**
Coppice, Osier **Reeds** **Marsh, Saltings**
Rough Grassland **Heath** **Culvert**
Direction of water flow **Triangulation Station** **Antiquity (site of)**
Electricity Transmission Line **Electricity Pylon**
B.M. 231.60m Bench Mark **Buildings with Building Seed**
Roofed Building **Glazed Roof Building**
Civil parish/community boundary
District boundary
County boundary
Boundary post/stone
Boundary mereing symbol (note: these always appear in opposed pairs or groups of three)
Bks Barracks **P** Pillar, Pole or Post
Bty Battery **PO** Post Office
Cemy Cemetery **PC** Public Convenience
Chy Chimney **Pp** Pump
Cis Cistern **Ppg Sta** Pumping Station
Dismtd Rly Dismantled Railway **PW** Place of Worship
EI Gen Sta Electricity Generating Station **Sewage Ppg Sta** Sewage Pumping Station
EI P Electricity Pole, Pillar **SB, S Br** Signal Box or Bridge
EI Sub Sta Electricity Sub Station **SP, SL** Signal Post or Light
FB Filter Bed **Spr** Spring
Fn / D Fn Fountain / Drinking Ftn. **Tk** Tank or Track
Gas Gov Gas Valve Compound **Tr** Trough
GVC Gas Governor **Wd Pp** Wind Pump
GP Guide Post **Wr Pt, Wr T** Water Point, Water Tap
MH Manhole **Wks** Works (building or area)
MP, MS Mile Post or Mile Stone **W** Well

Envirocheck®

LANDMARK INFORMATION GROUP®

Historical Mapping & Photography included:

Mapping Type	Scale	Date	Pg
Yorkshire	1:2,500	1892	2
Yorkshire	1:2,500	1910	3
Ordnance Survey Plan	1:2,500	1976	4
Large-Scale National Grid Data	1:2,500	1995	5

Historical Map - Segment C16

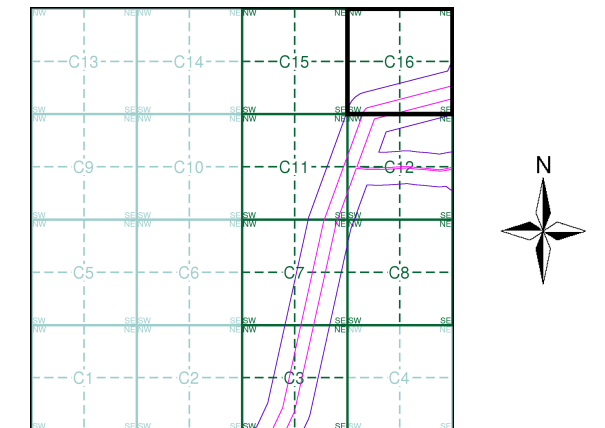

Order Details

Order Number: 201127465_1_1
 Customer Ref: PB8783-103-105
 National Grid Reference: 506560, 453280
 Slice: C
 Site Area (Ha): 72.
 Search Buffer (m): 100

Site Details

Hornsea Route

Landmark®
 LANDMARK INFORMATION GROUP

Tel: 0844 844 9952
 Fax: 0844 844 9951
 Web: www.envirocheck.co.uk

The historical maps shown were reproduced from maps predominantly held at the scale adopted for England, Wales and Scotland in the 1840's. In 1854 the 1:2,500 scale was adopted for mapping urban areas and by 1896 it covered the whole of what were considered to be the cultivated parts of Great Britain. The published date given below is often some years later than the surveyed date. Before 1938, all OS maps were based on the Cassini Projection, with independent surveys of a single county or group of counties, giving rise to significant inaccuracies in outlying areas.

Map Name(s) and Date(s)

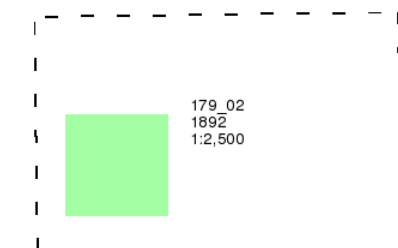

Historical Map - Segment C16

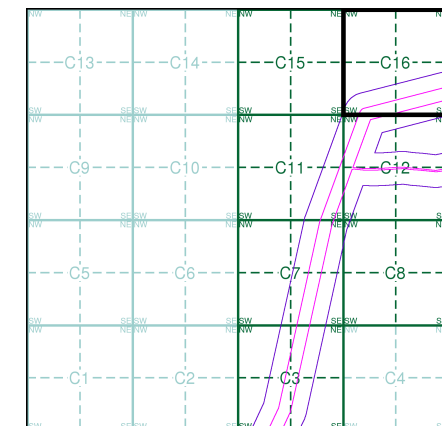

Order Details

Order Number: 201127465_1_1
 Customer Ref: PB8783-103-105
 National Grid Reference: 506560, 453280
 Slice: C
 Site Area (Ha): 72.
 Search Buffer (m): 100

Site Details

Hornsea Route

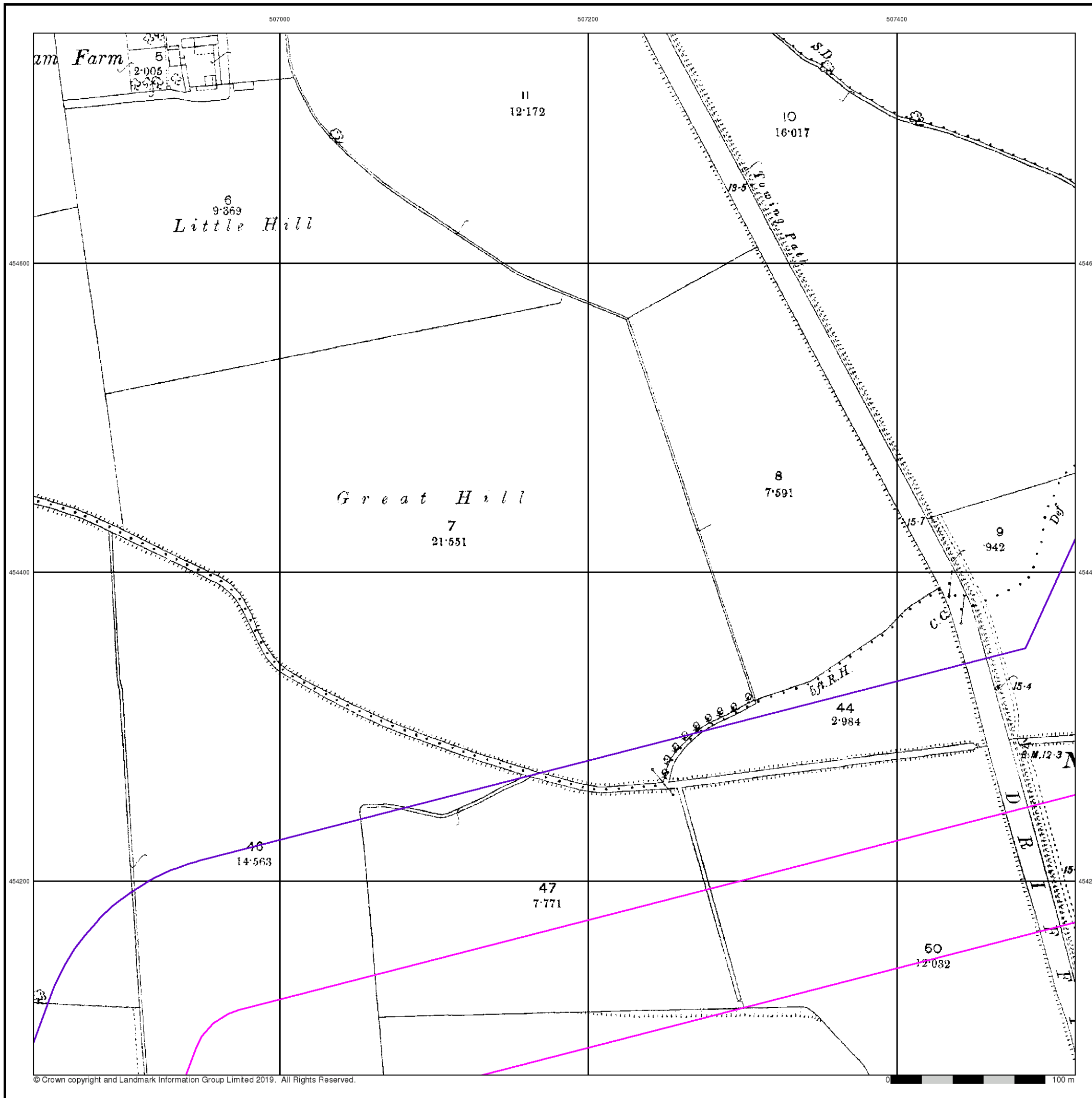

The historical maps shown were reproduced from maps predominantly held at the scale adopted for England, Wales and Scotland in the 1840's. In 1854 the 1:2,500 scale was adopted for mapping urban areas and by 1896 it covered the whole of what were considered to be the cultivated parts of Great Britain. The published date given below is often some years later than the surveyed date. Before 1938, all OS maps were based on the Cassini Projection, with independent surveys of a single county or group of counties, giving rise to significant inaccuracies in outlying areas.

Map Name(s) and Date(s)

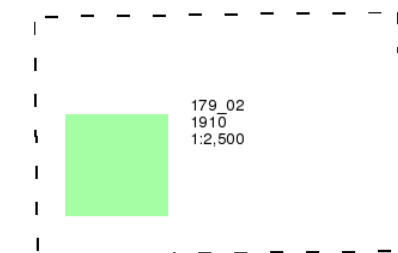

Historical Map - Segment C16

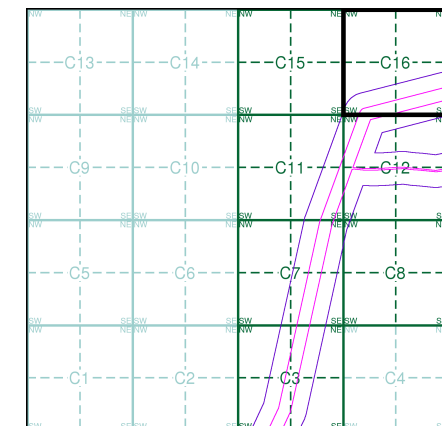

Order Details

Order Number: 201127465_1_1
 Customer Ref: PB8783-103-105
 National Grid Reference: 506560, 453280
 Slice: C
 Site Area (Ha): 72.
 Search Buffer (m): 100

Site Details

Hornsea Route

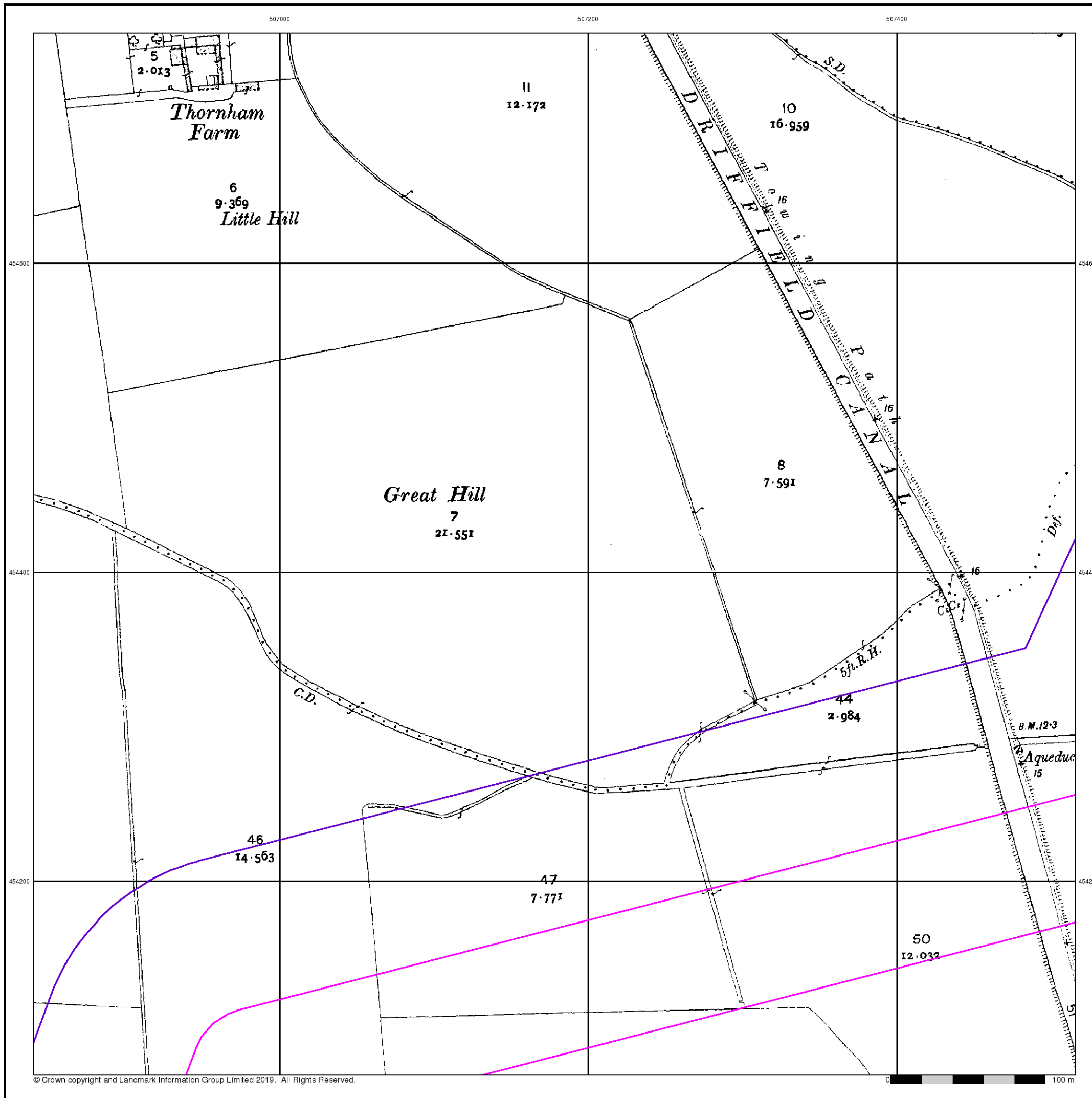

Ordnance Survey Plan

Published 1976

Source map scale - 1:2,500

The historical maps shown were reproduced from maps predominantly held at the scale adopted for England, Wales and Scotland in the 1840's. In 1854 the 1:2,500 scale was adopted for mapping urban areas and by 1896 it covered the whole of what were considered to be the cultivated parts of Great Britain. The published date given below is often some years later than the surveyed date. Before 1938, all OS maps were based on the Cassini Projection, with independent surveys of a single county or group of counties, giving rise to significant inaccuracies in outlying areas.

Map Name(s) and Date(s)

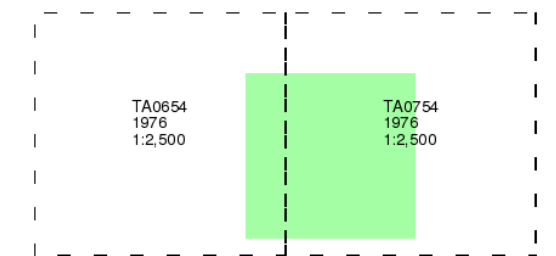

Historical Map - Segment C16

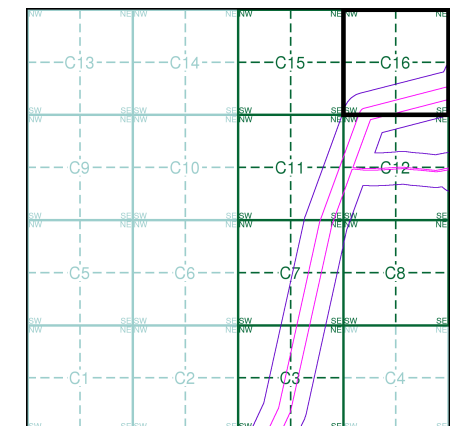

Order Details

Order Number: 201127465_1_1
 Customer Ref: PB8783-103-105
 National Grid Reference: 506560, 453280
 Slice: C
 Site Area (Ha): 72.
 Search Buffer (m): 100

Site Details

Hornsea Route

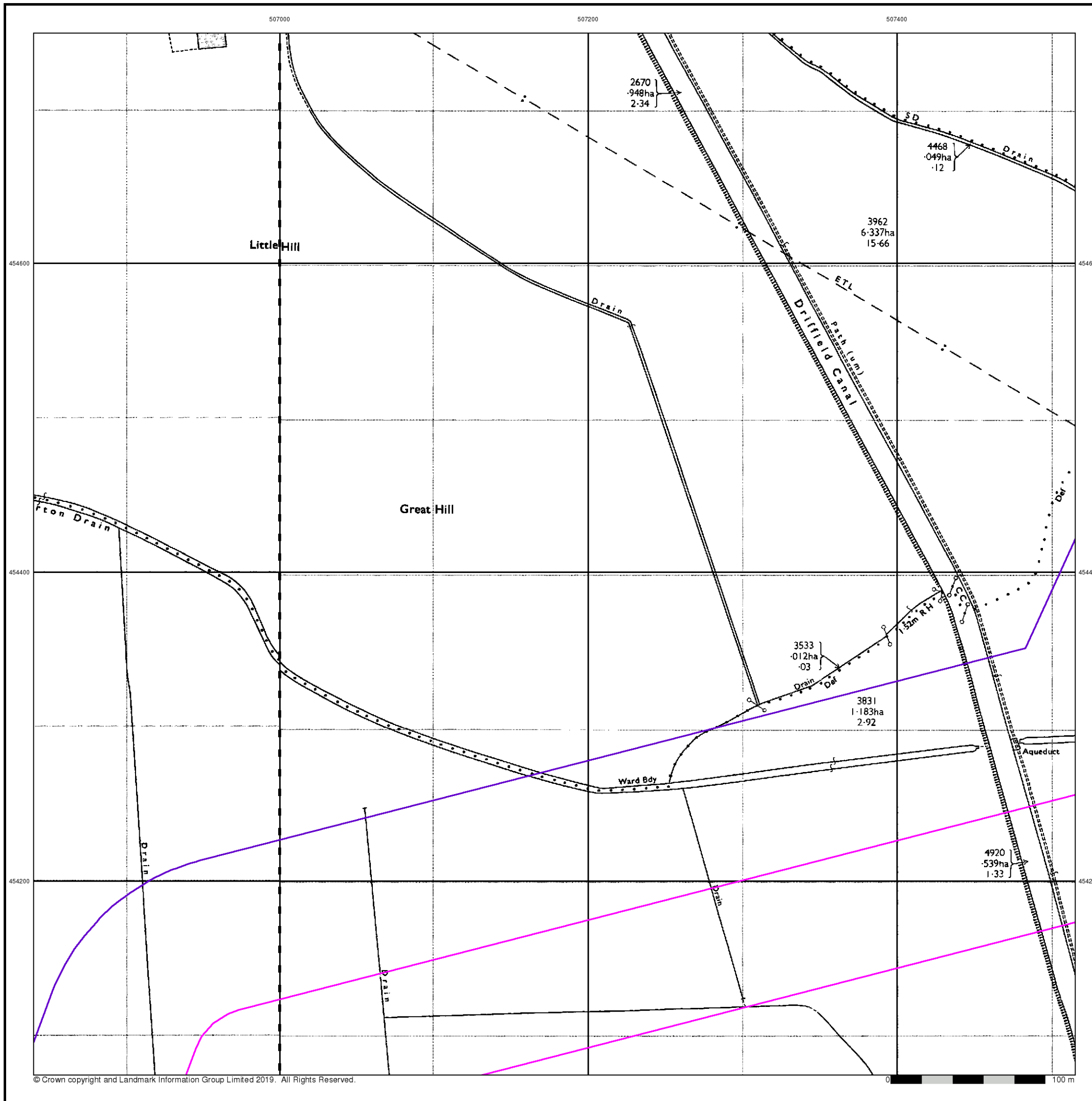

Large-Scale National Grid Data

Published 1995

Source map scale - 1:2,500

'Large Scale National Grid Data' superseded SIM cards (Ordnance Survey's 'Survey of Information on Microfilm') in 1992, and continued to be produced until 1999. These maps were the fore-runners of digital mapping and so provide detailed information on houses and roads, but tend to show less topographic features such as vegetation. These maps were produced at both 1:2,500 and 1:1,250 scales.

Map Name(s) and Date(s)

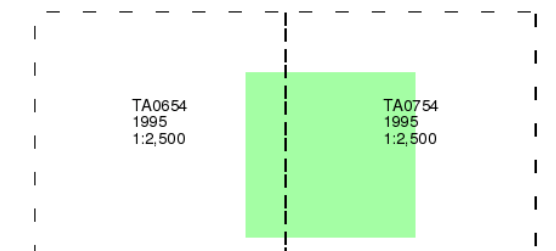

Historical Map - Segment C16

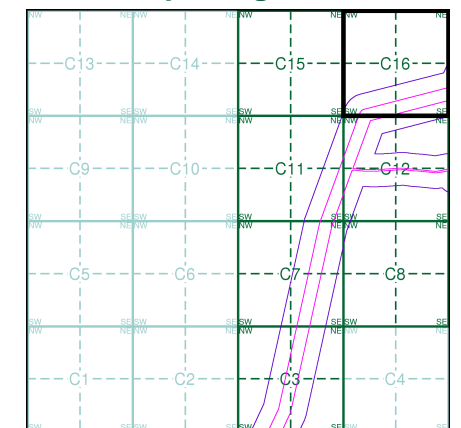

Order Details

Order Number: 201127465_1_1
 Customer Ref: PB8783-103-105
 National Grid Reference: 506560, 453280
 Slice: C
 Site Area (Ha): 72.
 Search Buffer (m): 100

Site Details

Hornsea Route

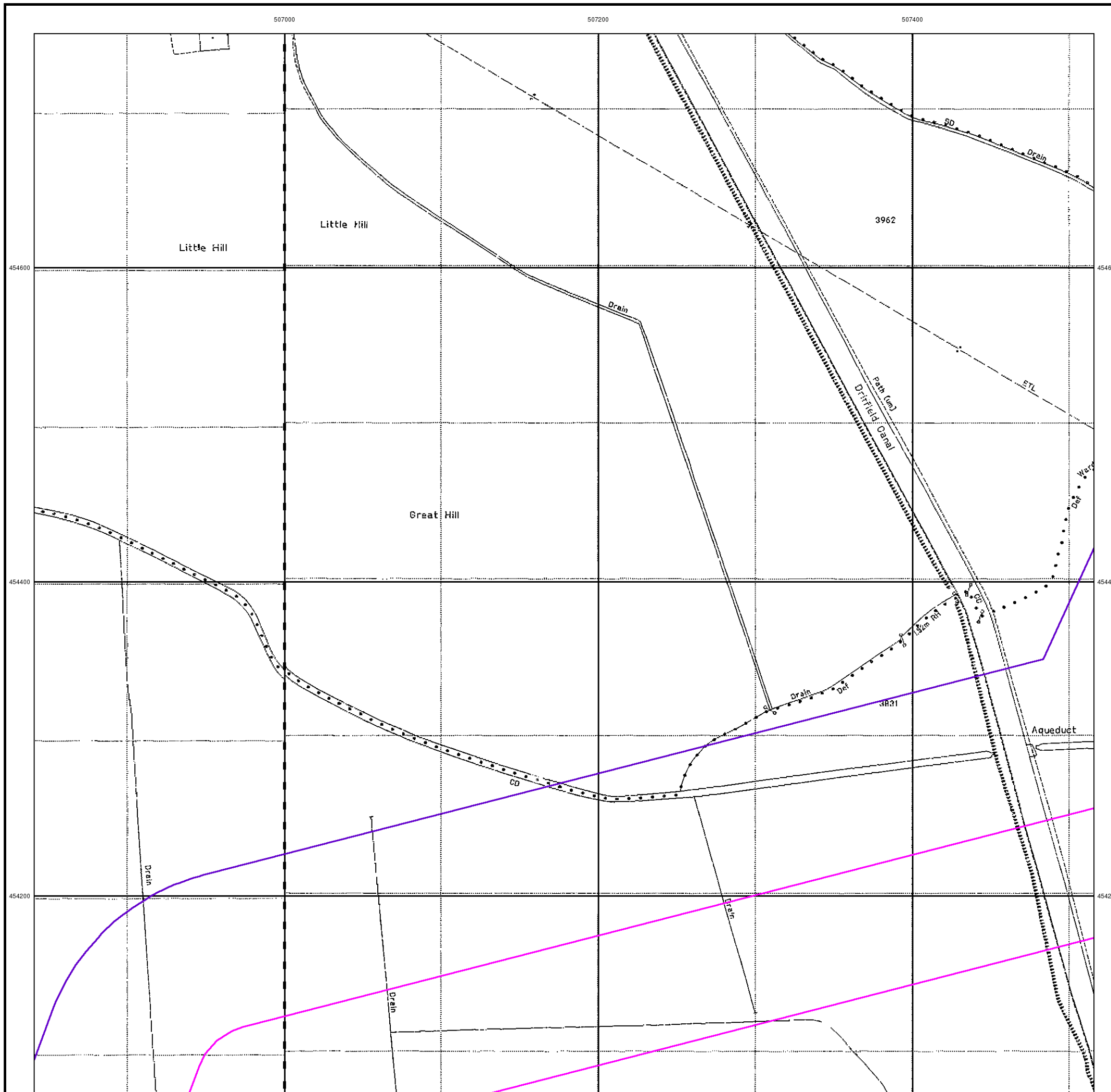

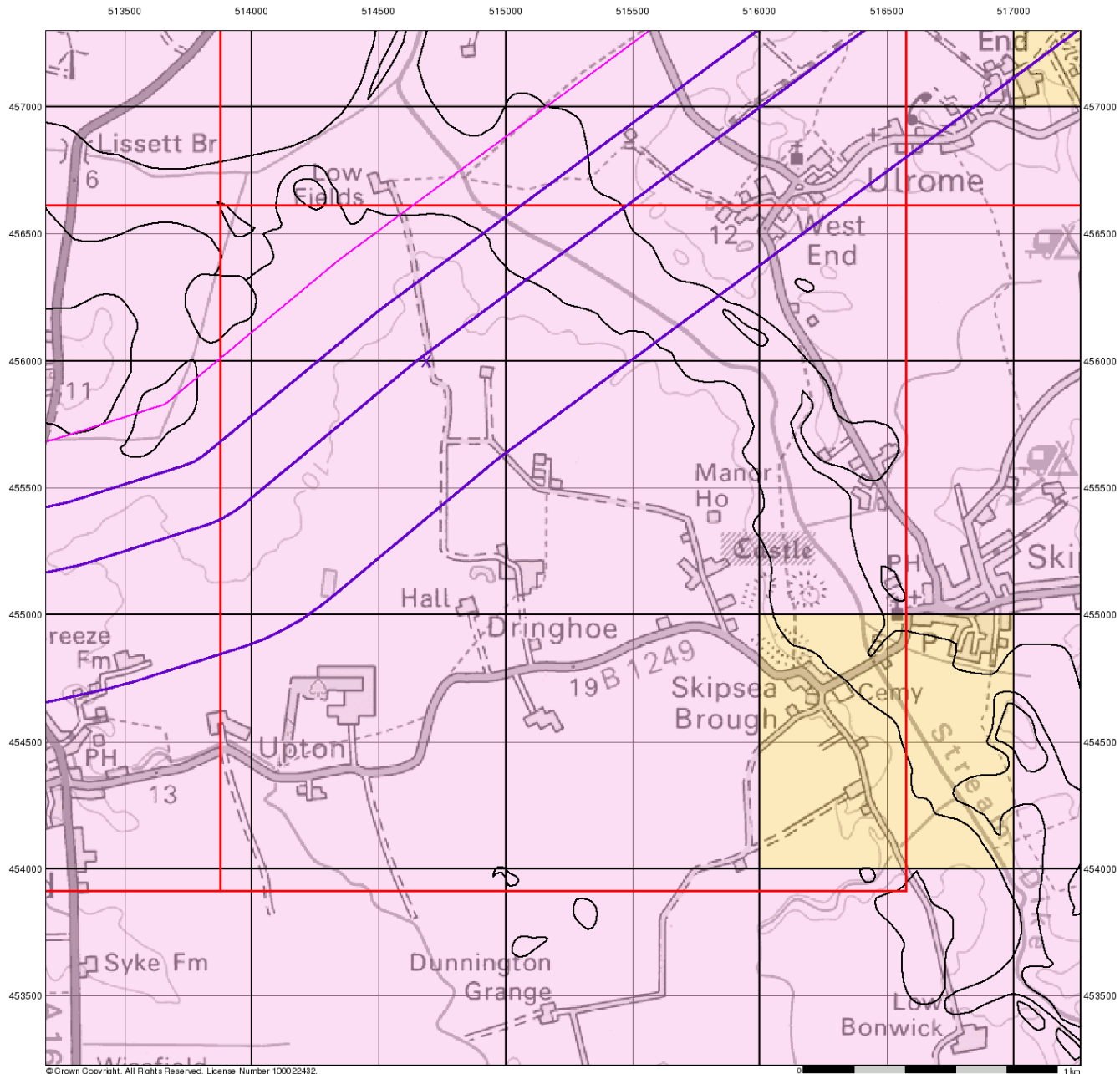

© Crown Copyright. All Rights Reserved. License Number 100022432.

Envirocheck®

LANDMARK INFORMATION GROUP®

Groundwater Vulnerability

General

- Specified Site
- Specified Buffer(s)
- Bearing Reference Point
- Slice
- Map ID

Agency and Hydrological

- | Bedrock Aquifers | Superficial Aquifers |
|---|---|
| High Vulnerability, Principal Aquifer | High Vulnerability, Principal Aquifer |
| High Vulnerability, Secondary Aquifer | High Vulnerability, Secondary Aquifer |
| Medium Vulnerability, Principal Aquifer | Medium Vulnerability, Principal Aquifer |
| Medium Vulnerability, Secondary Aquifer | Medium Vulnerability, Secondary Aquifer |
| Low Vulnerability, Principal Aquifer | Low Vulnerability, Principal Aquifer |
| Low Vulnerability, Secondary Aquifer | Low Vulnerability, Secondary Aquifer |

- Unproductive Aquifer
- Soluble Rock

Site Sensitivity Context Map - Slice C

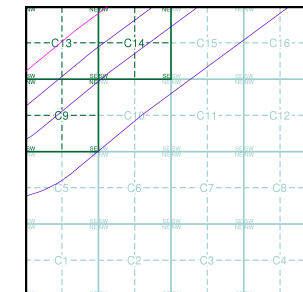

Order Details

Order Number: 201127462_1_1
 Customer Ref: PB8783-103-105
 National Grid Reference: 514690, 456000
 Slice: C
 Site Area (Ha): 2345.09
 Search Buffer (m): 1000

Site Details

Hornsea Route

Landmark
 INFORMATION GROUP

Tel: 0844 844 9952
 Fax: 0844 844 9951
 Web: www.envirocheck.co.uk

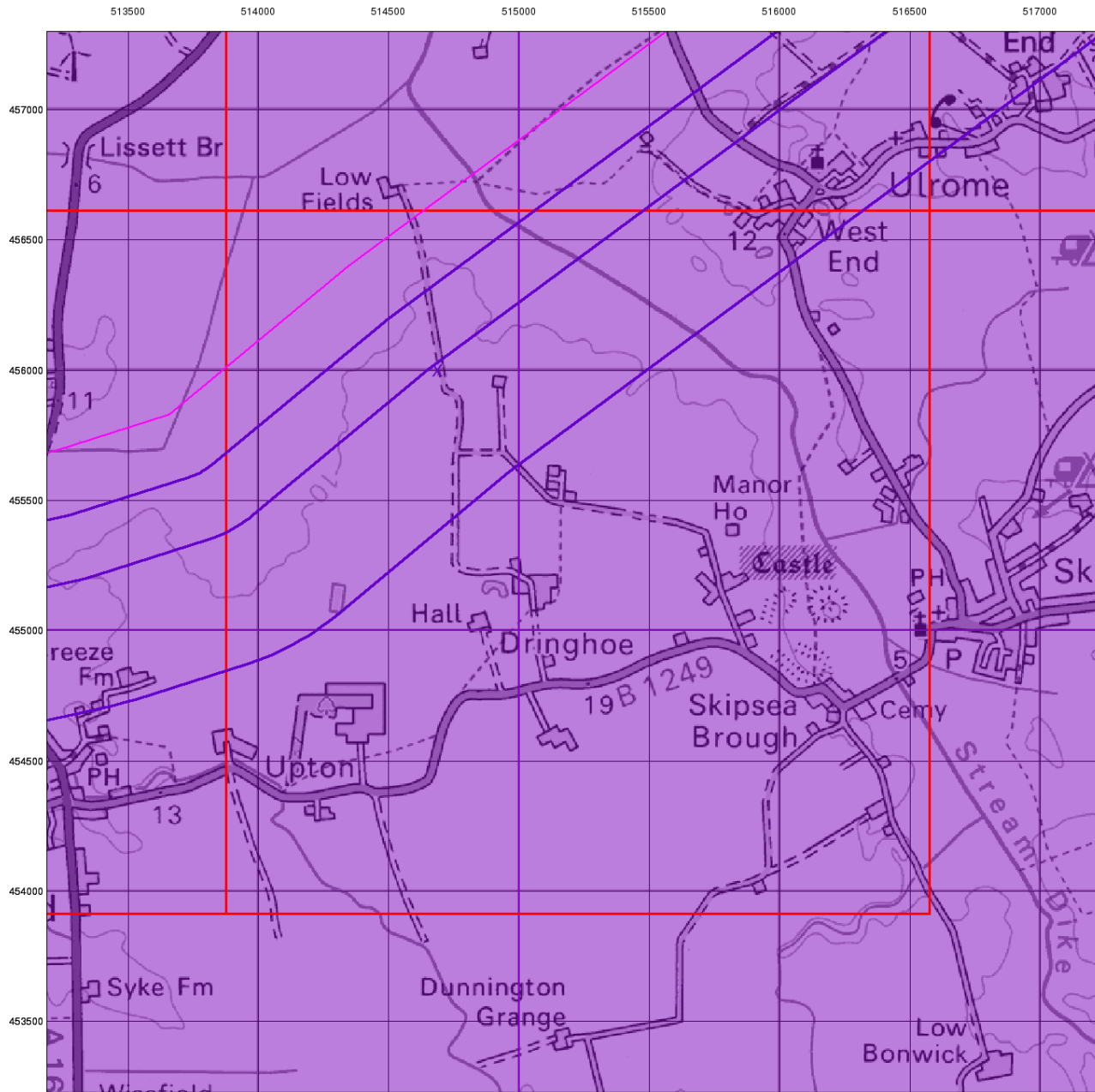

© Crown Copyright. All Rights Reserved. License Number 100022432.

0 1 km

Envirocheck®

● LANDMARK INFORMATION GROUP®

Bedrock Aquifer Designation

General

- Specified Site
- Specified Buffer(s)
- Bearing Reference Point
- Slice
- Map ID

Agency and Hydrological

Geological Classes

- Principal Aquifer
- Secondary A Aquifer
- Secondary B Aquifer
- Secondary Undifferentiated
- Unproductive Strata
- Unknown
- Unknown (Lakes and Landslip)

Site Sensitivity Context Map - Slice C

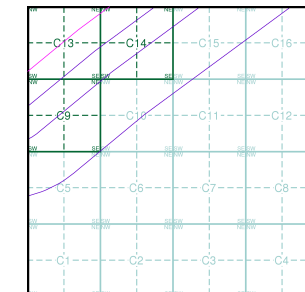

Order Details

Order Number: 201127462_1_1
 Customer Ref: PB8783-103-105
 National Grid Reference: 514690, 456000
 Slice: C
 Site Area (Ha): 2345.09
 Search Buffer (m): 1000

Site Details

Hornsea Route

Landmark®
 ● LANDMARK INFORMATION GROUP

Tel: 0844 844 9952
 Fax: 0844 844 9951
 Web: www.envirocheck.co.uk

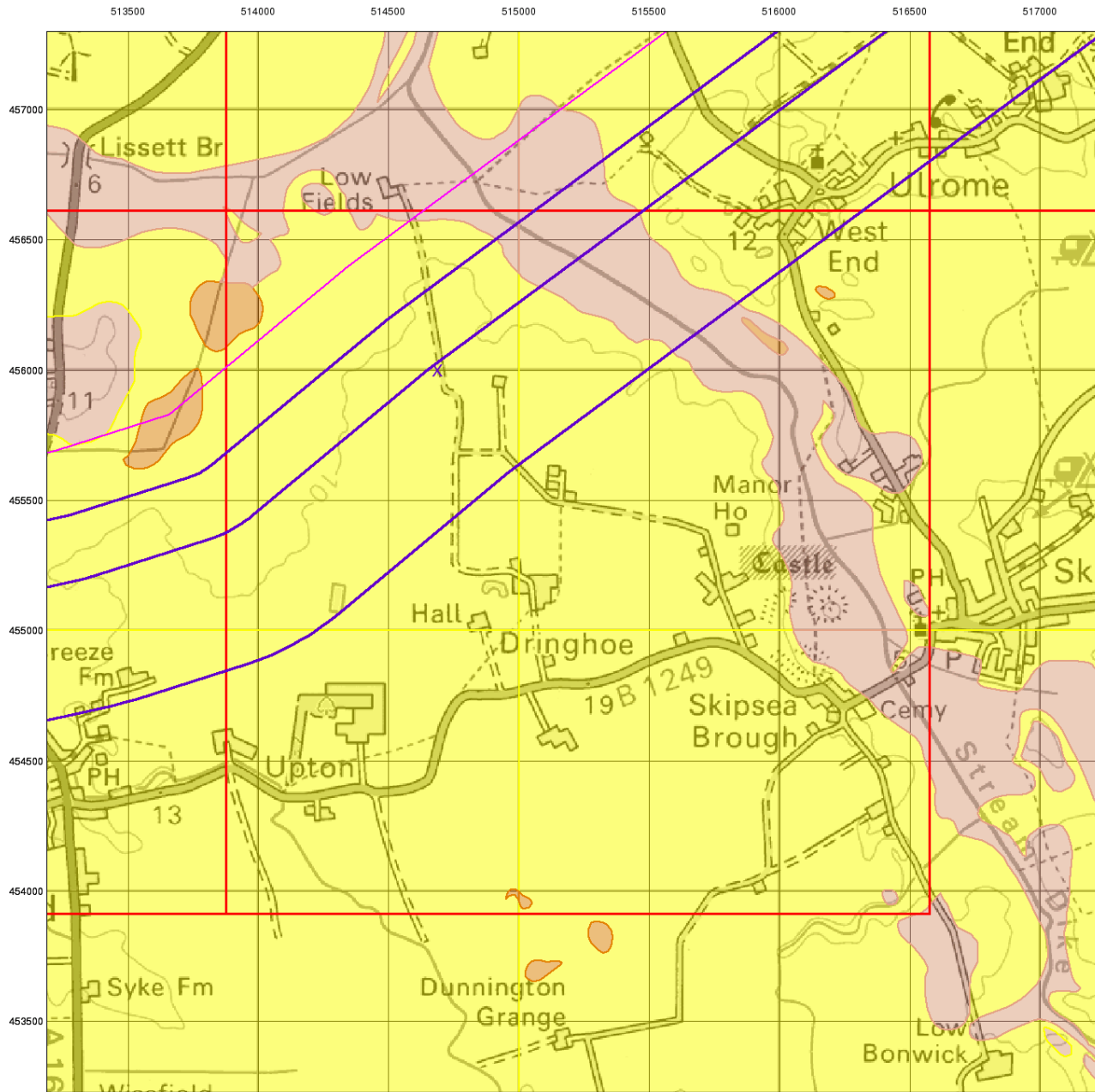

© Crown Copyright. All Rights Reserved. License Number 100022432.

0 1 km

Envirocheck®

LANDMARK INFORMATION GROUP®

Superficial Aquifer Designation

General

- Specified Site
- Specified Buffer(s)
- Bearing Reference Point
- Slice
- Map ID

Agency and Hydrological

Geological Classes

- Principal Aquifer
- Secondary A Aquifer
- Secondary B Aquifer
- Secondary Undifferentiated
- Unproductive Strata
- Unknown
- Unknown (Lakes and Landslip)

Site Sensitivity Context Map - Slice C

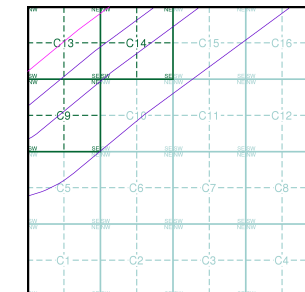

Order Details

Order Number: 201127462_1_1
 Customer Ref: PB8783-103-105
 National Grid Reference: 514690, 456000
 Slice: C
 Site Area (Ha): 2345.09
 Search Buffer (m): 1000

Site Details

Hornsea Route

Landmark®
 LANDMARK INFORMATION GROUP

Tel: 0844 844 9952
 Fax: 0844 844 9951
 Web: www.envirocheck.co.uk

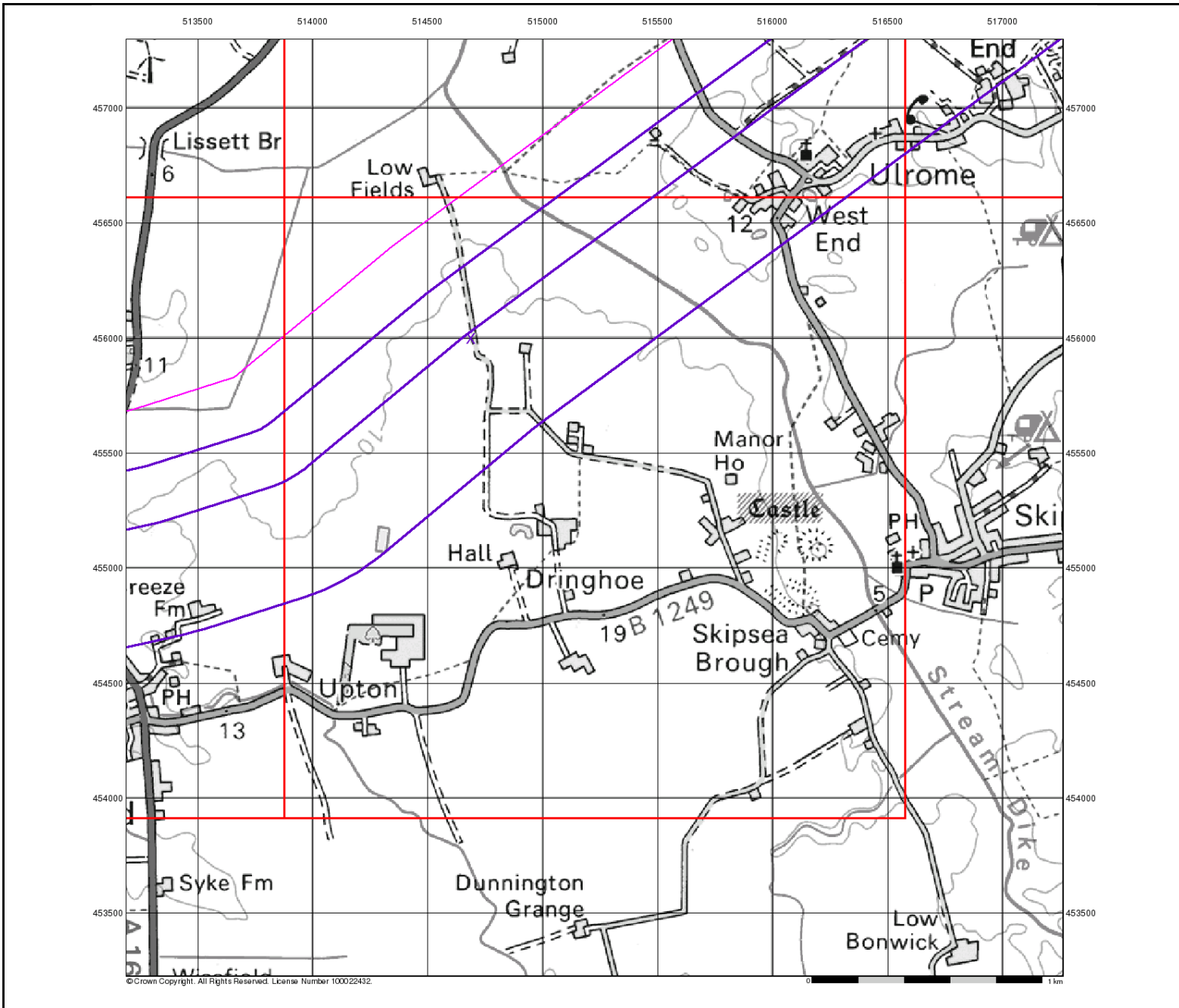

© Crown Copyright. All Rights Reserved. License Number 100022432.

Envirocheck[®]

● LANDMARK INFORMATION GROUP[®]

Source Protection Zones

General

- ◇ Specified Site
- ◇ Specified Buffer(s)
- X Bearing Reference Point
- Slice
- B Map ID

Agency and Hydrological

- Inner zone (Zone 1)
- Inner zone - subsurface activity only (Zone 1c)
- Outer zone (Zone 2)
- Outer zone - subsurface activity only (Zone 2c)
- Total catchment (Zone 3)
- Total catchment - subsurface activity only (Zone 3c)
- Special interest (Zone 4)

Site Sensitivity Context Map - Slice C

Order Details

Order Number:	201127462_1_1
Customer Ref:	PB8783-103-105
National Grid Reference:	514690, 456000
Slice:	C
Site Area (Ha):	2345.09
Search Buffer (m):	1000

Site Details
Hornsea Route

Landmark[®]
● LANDMARK INFORMATION GROUP

Tel: 0844 844 9952
Fax: 0844 844 9951
Web: www.envirocheck.co.uk

A Landmark Information Group Service v15.0 17-Apr-2019 Page 4 of 6

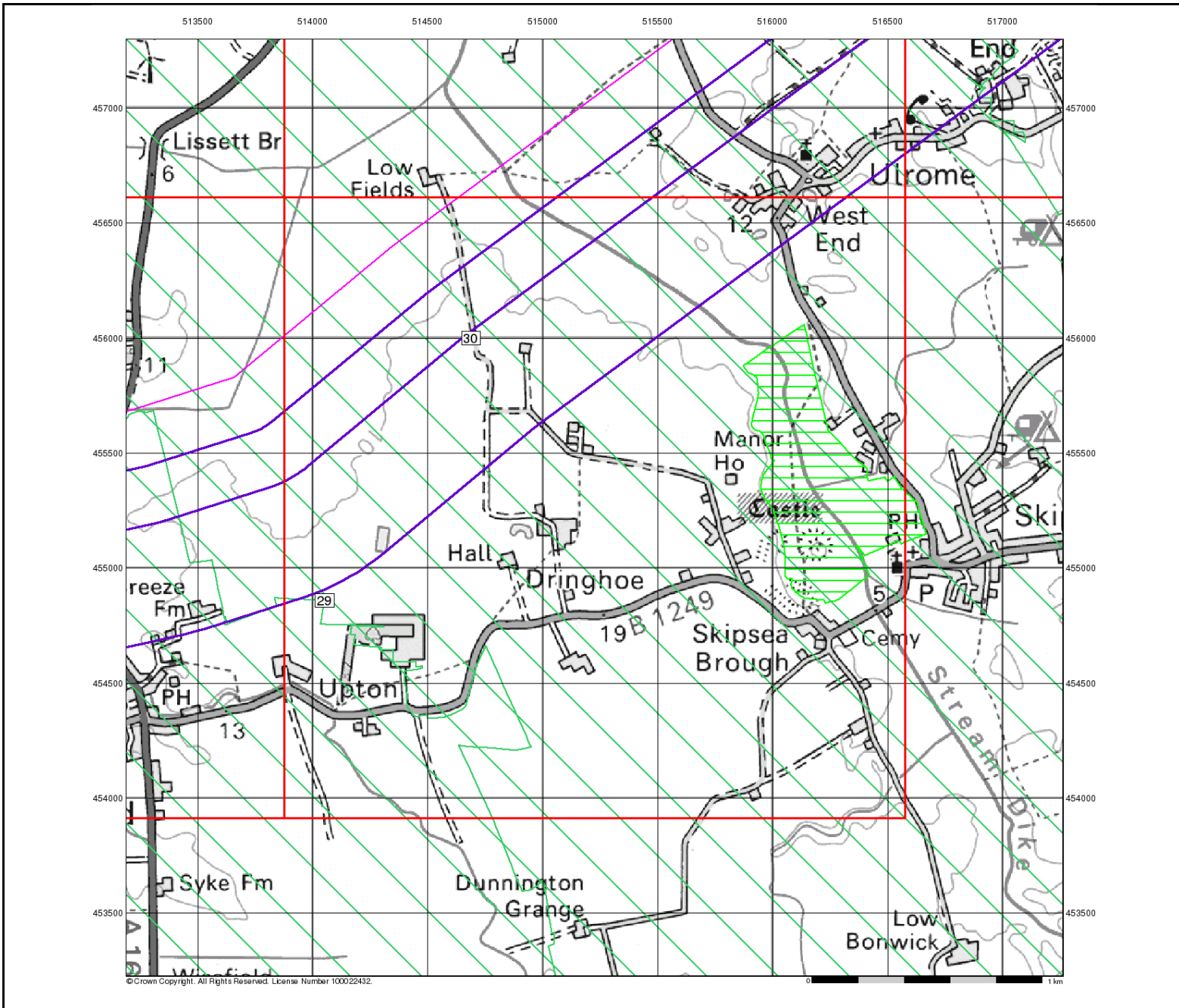

© Crown Copyright. All Rights Reserved. License Number 100022432.

Envirocheck®

● LANDMARK INFORMATION GROUP®

Sensitive Land Uses

General

- ◆ Specified Site
- ◻ Specified Buffer(s)
- ✕ Bearing Reference Point
- ◻ Slice
- B Map ID

Sensitive Land Uses

- Ancient Woodland
- Area of Adopted Green Belt
- Area of Unadopted Green Belt
- Area of Outstanding Natural Beauty
- Environmentally Sensitive Area
- Forest Park
- Local Nature Reserve
- Marine Nature Reserve
- National Nature Reserve
- National Park
- Nitrate Sensitive Area
- Nitrate Vulnerable Zone
- Ramsar Site
- Site of Special Scientific Interest
- Special Area of Conservation
- Special Protection Area
- World Heritage Sites

Site Sensitivity Context Map - Slice C

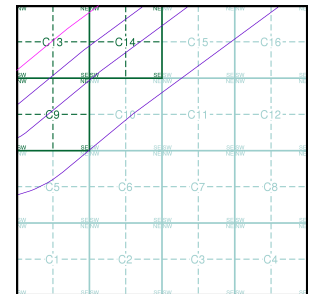

Order Details

Order Number: 201127462_1_1
 Customer Ref: PB8783-103-105
 National Grid Reference: 514690, 456000
 Slice: C
 Site Area (Ha): 2345.09
 Search Buffer (m): 1000

Site Details

Hornsea Route

Landmark®
 ● LANDMARK INFORMATION GROUP

Tel: 0844 844 9952
 Fax: 0844 844 9951
 Web: www.envirocheck.co.uk

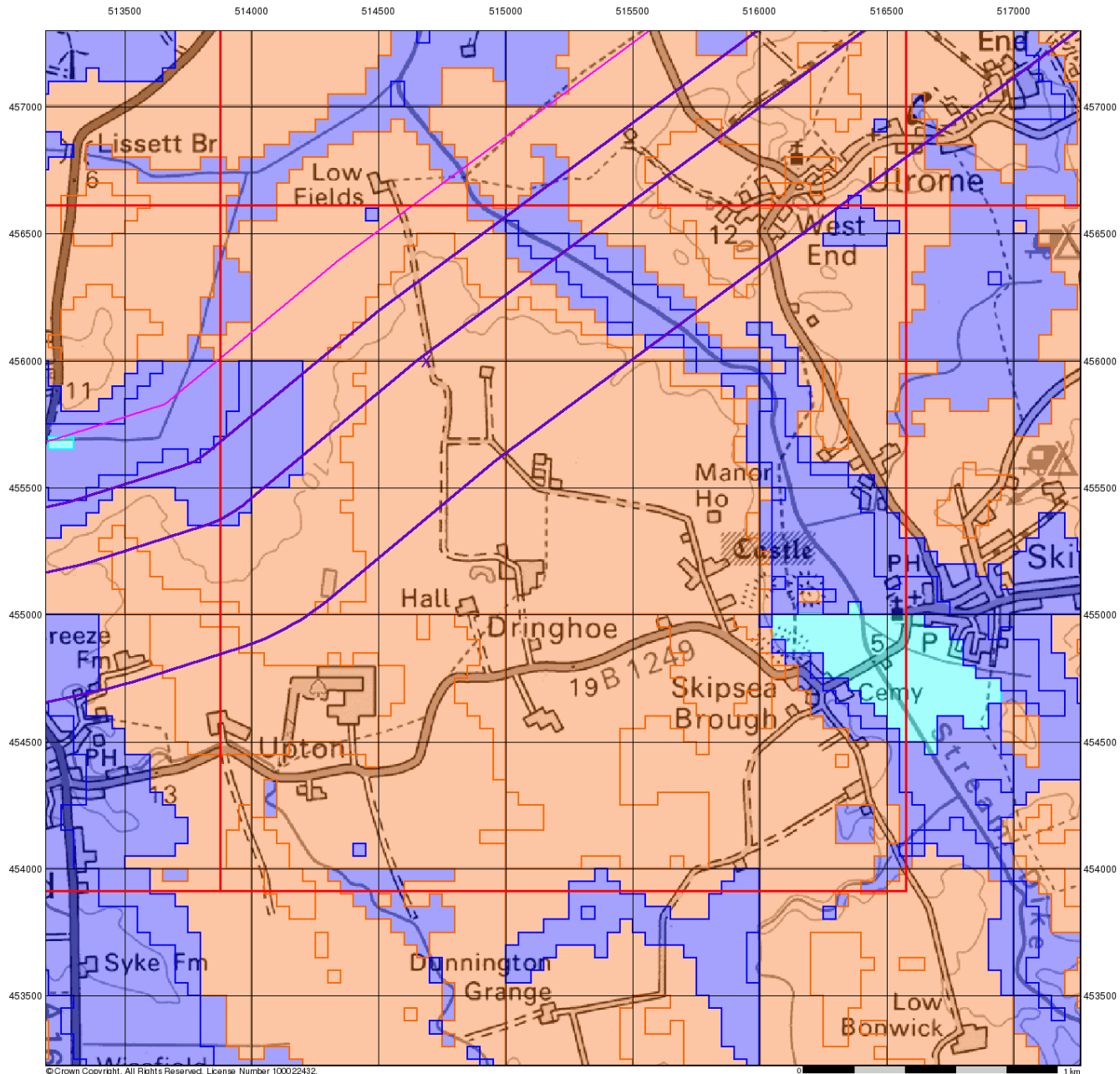

© Crown Copyright. All Rights Reserved. License Number 100022432.

Envirocheck®

LANDMARK INFORMATION GROUP®

BGS Flood GFS Data

General

- Specified Site
- Specified Buffer(s)
- Bearing Reference Point
- Slice

Agency and Hydrological (Flood)

- Limited Potential for Groundwater Flooding to Occur
- Potential for Groundwater Flooding of Property Situated Below Ground Level
- Potential for Groundwater Flooding to Occur at Surface

Site Sensitivity Context Map - Slice C

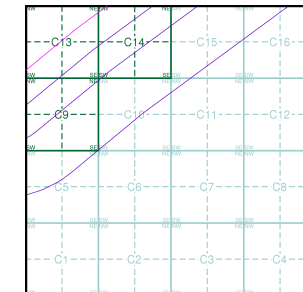

Order Details

Order Number: 201127462_1_1
 Customer Ref: PB8783-103-105
 National Grid Reference: 514690, 456000
 Slice: C
 Site Area (Ha): 2345.09
 Search Buffer (m): 1000

Site Details

Hornsea Route

Landmark®
 INFORMATION GROUP

Tel: 0844 844 9952
 Fax: 0844 844 9951
 Web: www.envirocheck.co.uk

504500 505000 505500 506000 506500 507000 507500 508000

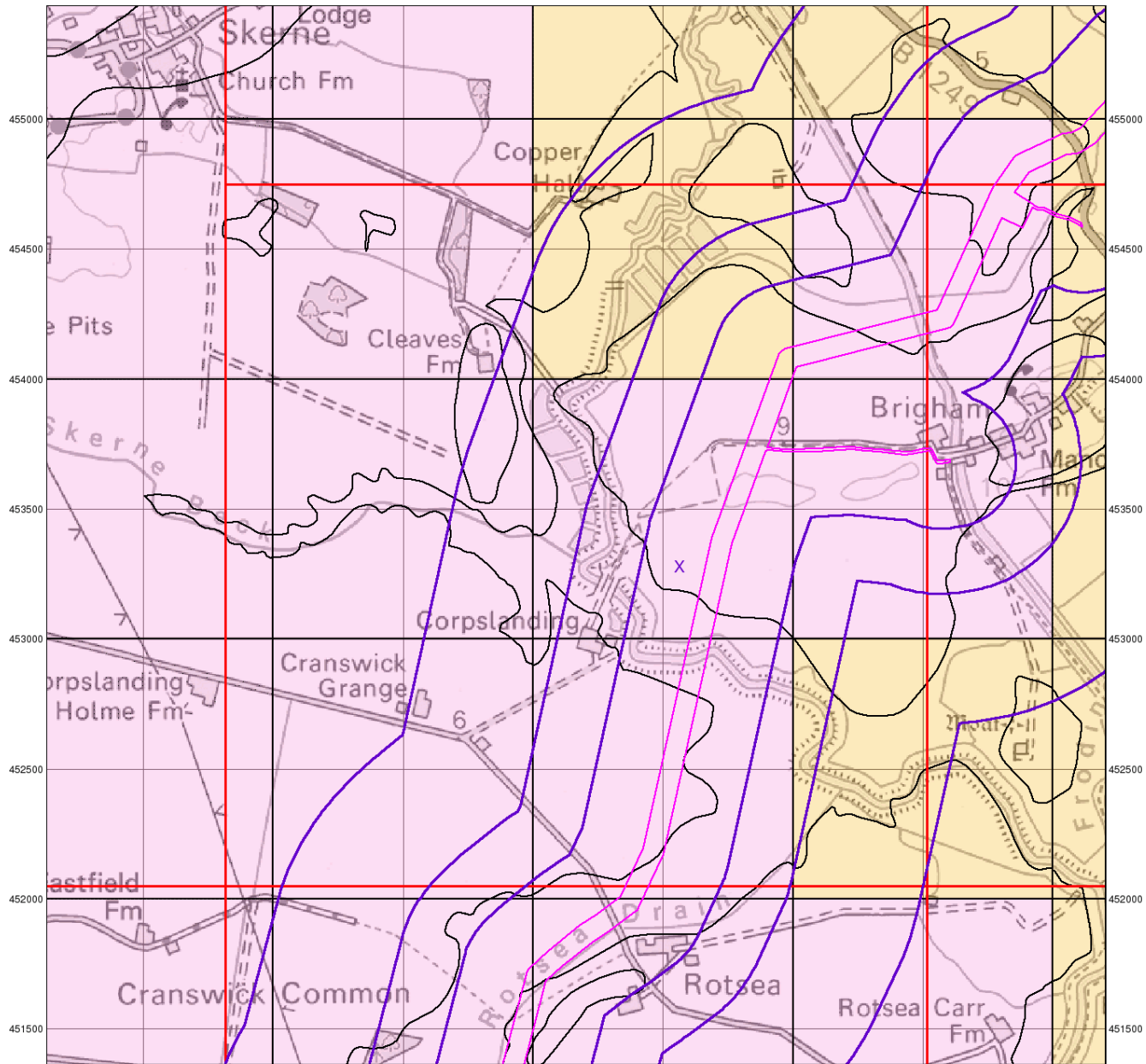

© Crown Copyright. All Rights Reserved. License Number 100022432.

0 1 km

Envirocheck®

LANDMARK INFORMATION GROUP®

Groundwater Vulnerability

General

- Specified Site
- Specified Buffer(s)
- Bearing Reference Point
- Slice
- Map ID

Agency and Hydrological

Bedrock Aquifers	Superficial Aquifers
High Vulnerability, Principal Aquifer	High Vulnerability, Principal Aquifer
High Vulnerability, Secondary Aquifer	High Vulnerability, Secondary Aquifer
Medium Vulnerability, Principal Aquifer	Medium Vulnerability, Principal Aquifer
Medium Vulnerability, Secondary Aquifer	Medium Vulnerability, Secondary Aquifer
Low Vulnerability, Principal Aquifer	Low Vulnerability, Principal Aquifer
Low Vulnerability, Secondary Aquifer	Low Vulnerability, Secondary Aquifer

- Unproductive Aquifer
- Soluble Rock

Site Sensitivity Context Map - Slice C

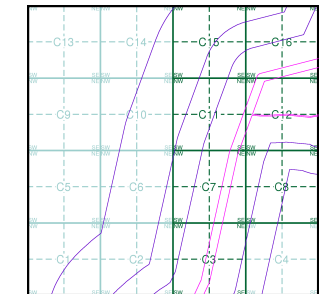

Order Details

Order Number: 201127465_1_1
 Customer Ref: PB8783-103-105
 National Grid Reference: 506560, 453280
 Slice: C
 Site Area (Ha): 72
 Search Buffer (m): 1000

Site Details

Hornsea Route

Landmark
 INFORMATION GROUP

Tel: 0844 844 9952
 Fax: 0844 844 9951
 Web: www.envirocheck.co.uk

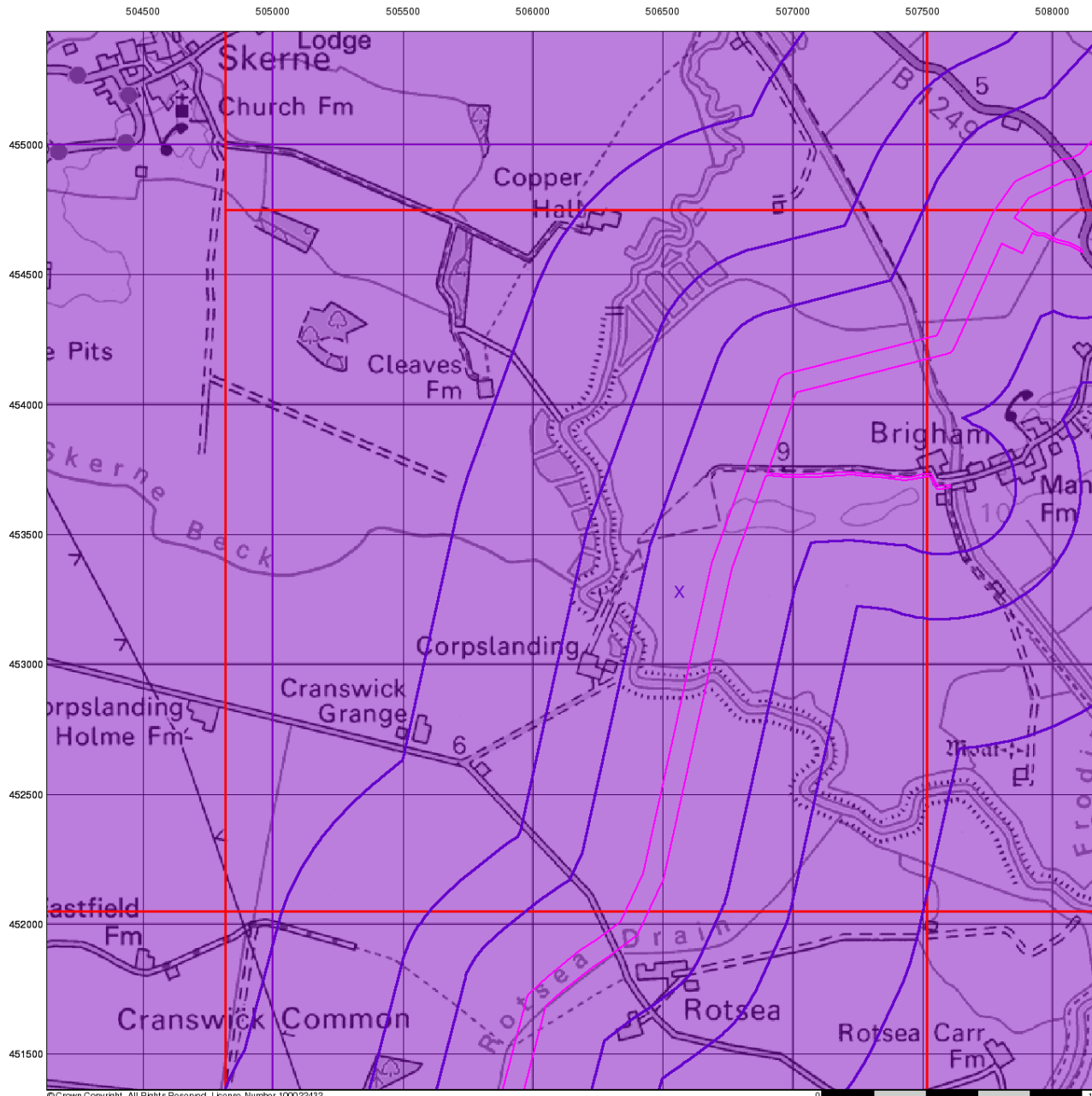

© Crown Copyright. All Rights Reserved. License Number 100022432.

0 1 km

Envirocheck[®]

● LANDMARK INFORMATION GROUP[®]

Bedrock Aquifer Designation

General

- ▭ Specified Site
- ▭ Specified Buffer(s)
- X Bearing Reference Point
- ▭ Slice
- B Map ID

Agency and Hydrological

Geological Classes

- Principal Aquifer
- Secondary A Aquifer
- Secondary B Aquifer
- Secondary Undifferentiated
- Unproductive Strata
- Unknown
- Unknown (Lakes and Landslip)

Site Sensitivity Context Map - Slice C

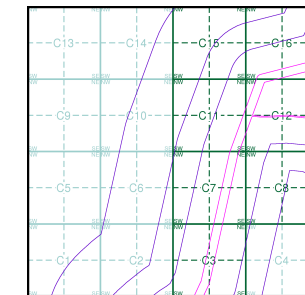

Order Details

Order Number: 201127465_1_1
 Customer Ref: PB8783-103-105
 National Grid Reference: 506560, 453280
 Slice: C
 Site Area (Ha): 72
 Search Buffer (m): 1000

Site Details

Hornsea Route

Landmark[®]
 ● LANDMARK INFORMATION GROUP

Tel: 0844 844 9952
 Fax: 0844 844 9951
 Web: www.envirocheck.co.uk

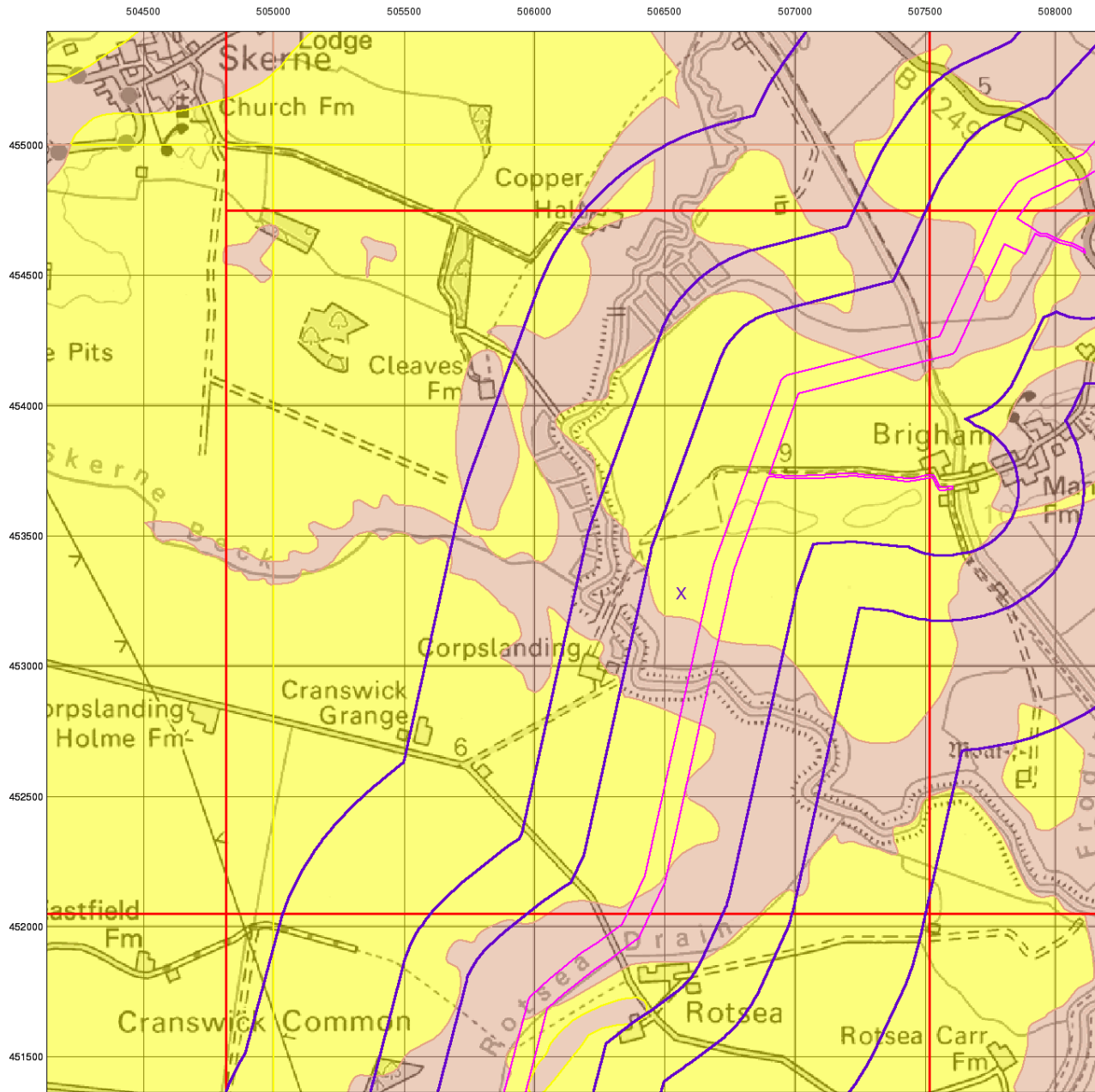

© Crown Copyright. All Rights Reserved. License Number 100022432.

0 1 km

Envirocheck[®]

● LANDMARK INFORMATION GROUP[®]

Superficial Aquifer Designation

General

- Specified Site
- Specified Buffer(s)
- Bearing Reference Point
- Slice
- Map ID

Agency and Hydrological

Geological Classes

- Principal Aquifer
- Secondary A Aquifer
- Secondary B Aquifer
- Secondary Undifferentiated
- Unproductive Strata
- Unknown
- Unknown (Lakes and Landslip)

Site Sensitivity Context Map - Slice C

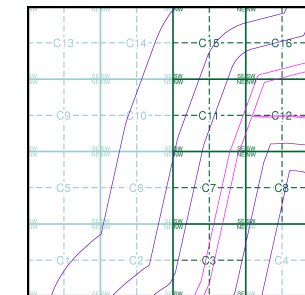

Order Details

Order Number: 201127465_1_1
 Customer Ref: PB8783-103-105
 National Grid Reference: 506560, 453280
 Slice: C
 Site Area (Ha): 72
 Search Buffer (m): 1000

Site Details

Hornsea Route

Landmark[®]
 ● LANDMARK INFORMATION GROUP

Tel: 0844 844 9952
 Fax: 0844 844 9951
 Web: www.envirocheck.co.uk

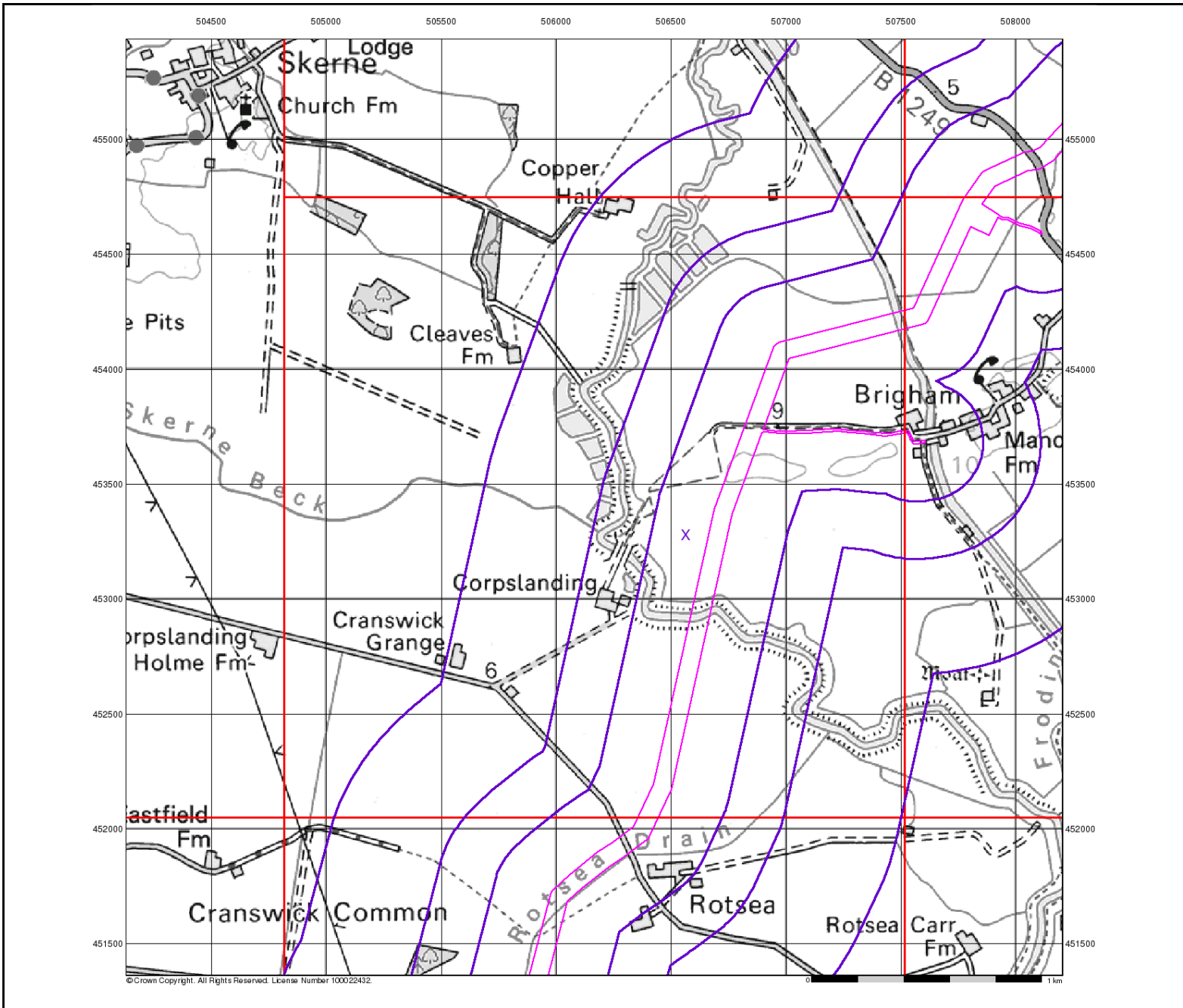

© Crown Copyright. All Rights Reserved. License Number 100022432.

Envirocheck®

● LANDMARK INFORMATION GROUP®

Source Protection Zones

General

- Specified Site
- Specified Buffer(s)
- Bearing Reference Point
- Slice
- Map ID

Agency and Hydrological

- Inner zone (Zone 1)
- Inner zone - subsurface activity only (Zone 1c)
- Outer zone (Zone 2)
- Outer zone - subsurface activity only (Zone 2c)
- Total catchment (Zone 3)
- Total catchment - subsurface activity only (Zone 3c)
- Special interest (Zone 4)

Site Sensitivity Context Map - Slice C

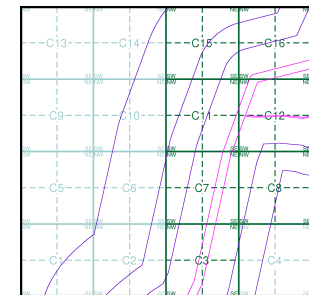

Order Details

Order Number: 201127465_1_1
 Customer Ref: PB8783-103-105
 National Grid Reference: 506560, 453280
 Slice: C
 Site Area (Ha): 72
 Search Buffer (m): 1000

Site Details

Hornsea Route

Landmark®
 ● LANDMARK INFORMATION GROUP

Tel: 0844 844 9952
 Fax: 0844 844 9951
 Web: www.envirocheck.co.uk

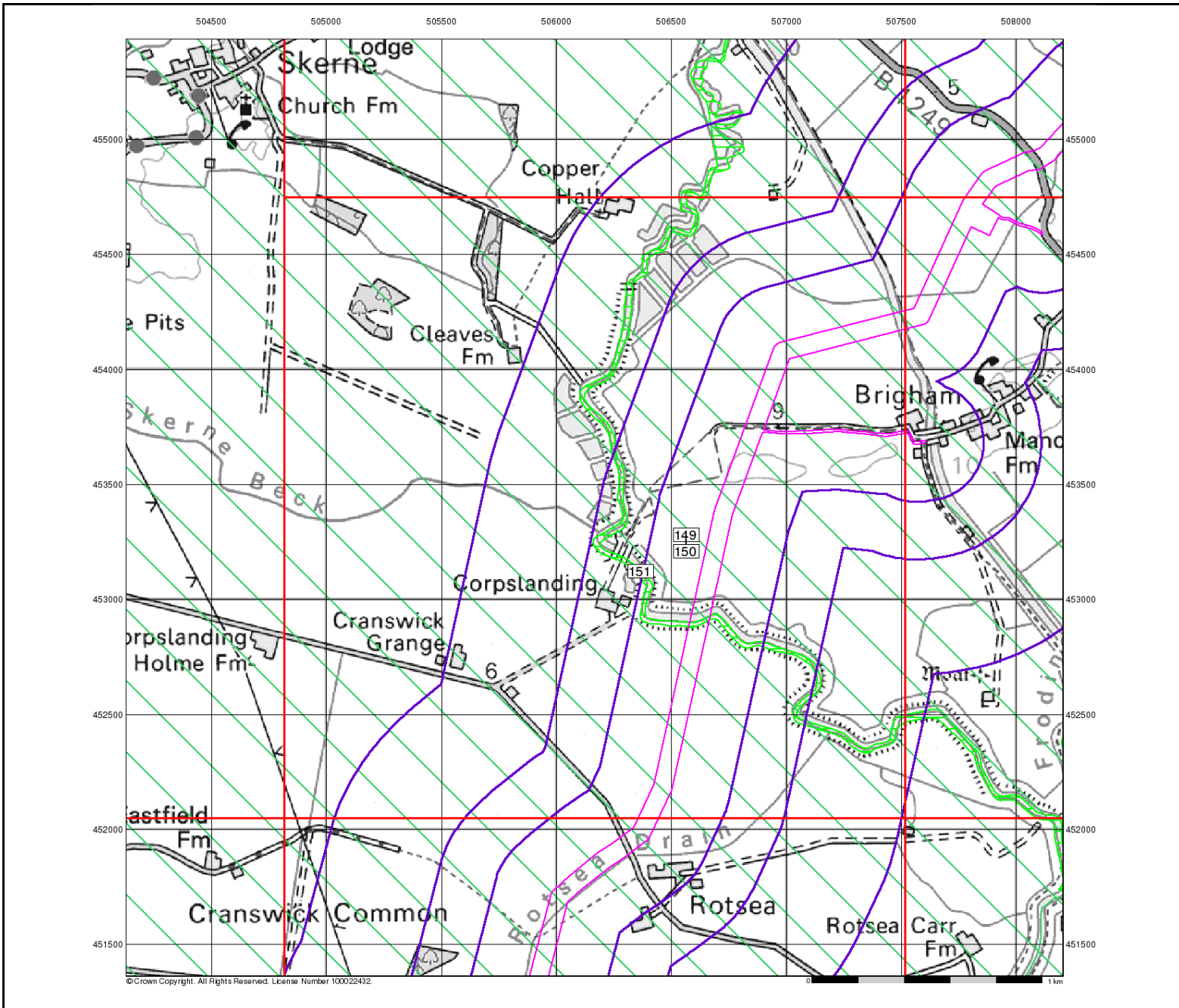

© Crown Copyright. All Rights Reserved. License Number 100022432.

Envirocheck[®]

● LANDMARK INFORMATION GROUP[®]

Sensitive Land Uses

General

- ◇ Specified Site
- ◇ Specified Buffer(s)
- X Bearing Reference Point
- Slice
- B Map ID

Sensitive Land Uses

 Ancient Woodland	N National Park
 Area of Adopted Green Belt	 Nitrate Sensitive Area
 Area of Unadopted Green Belt	 Nitrate Vulnerable Zone
 Area of Outstanding Natural Beauty	 Ramsar Site
 Environmentally Sensitive Area	 Site of Special Scientific Interest
 Forest Park	 Special Area of Conservation
 Local Nature Reserve	 Special Protection Area
 Marine Nature Reserve	 World Heritage Sites
 National Nature Reserve	

Site Sensitivity Context Map - Slice C

N

Order Details

Order Number:	201127465_1_1
Customer Ref:	PB8783-103-105
National Grid Reference:	506560, 453280
Slice:	C
Site Area (Ha):	72.
Search Buffer (m):	1000

Site Details
Hornsea Route

Landmark[®]
● LANDMARK INFORMATION GROUP

Tel: 0844 844 9952
Fax: 0844 844 9951
Web: www.envirocheck.co.uk

A Landmark Information Group Service v15.0 17-Apr-2019 Page 5 of 6

504500 505000 505500 506000 506500 507000 507500 508000

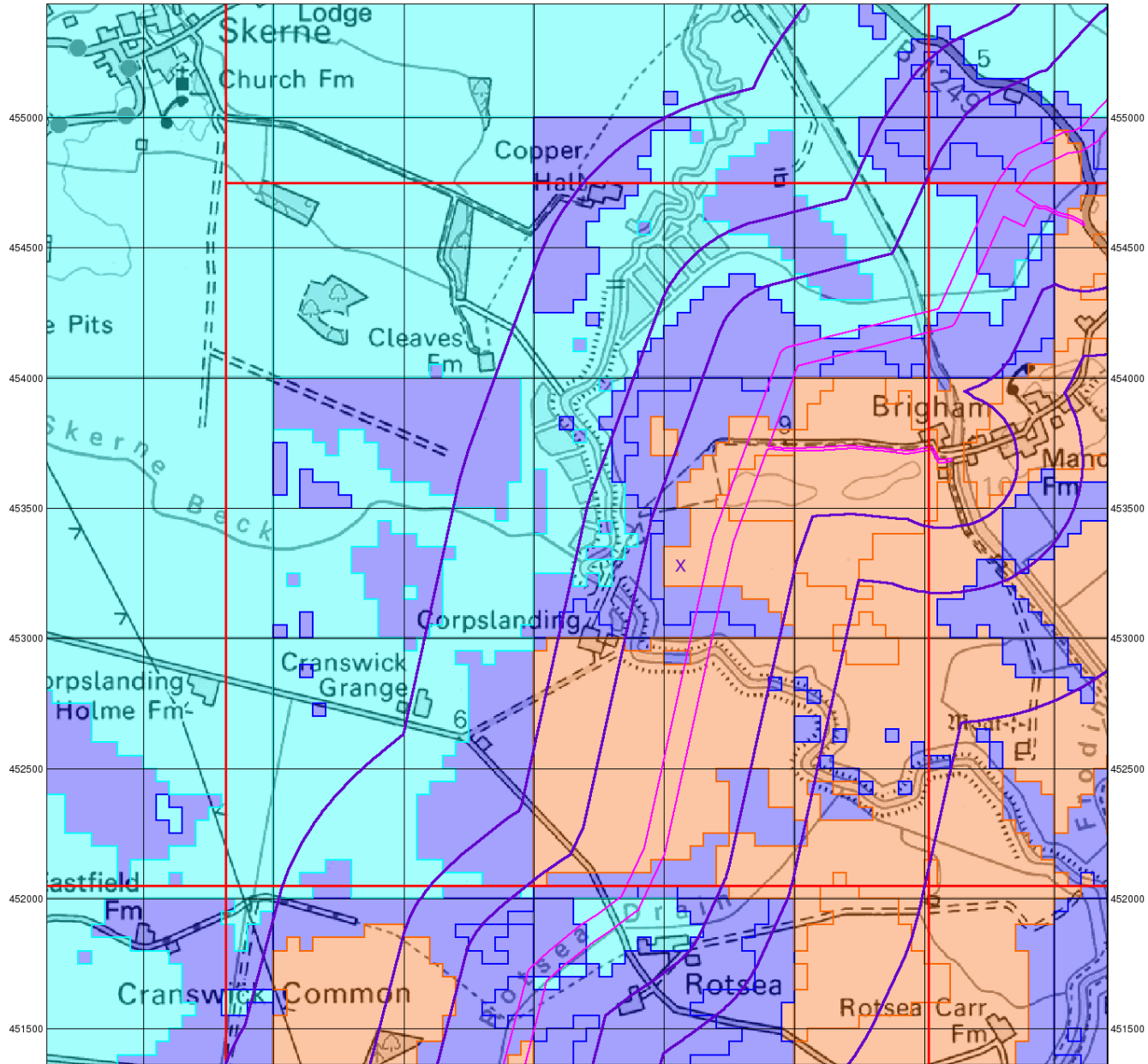

© Crown Copyright. All Rights Reserved. License Number 100022432.

0 1 km

Envirocheck®

● LANDMARK INFORMATION GROUP®

BGS Flood GFS Data

General

- Specified Site
- Specified Buffer(s)
- Bearing Reference Point
- Slice

Agency and Hydrological (Flood)

- Limited Potential for Groundwater Flooding to Occur
- Potential for Groundwater Flooding of Property Situated Below Ground Level
- Potential for Groundwater Flooding to Occur at Surface

Site Sensitivity Context Map - Slice C

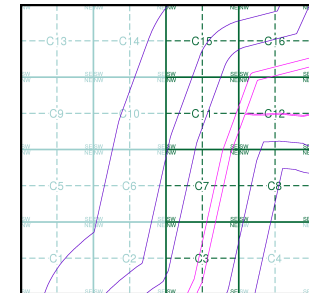

Order Details

Order Number: 201127465_1_1
 Customer Ref: PB8783-103-105
 National Grid Reference: 506560, 453280
 Slice: C
 Site Area (Ha): 72
 Search Buffer (m): 1000

Site Details

Hornsea Route

Landmark®
 ●●● INFORMATION GROUP

Tel: 0844 844 9952
 Fax: 0844 844 9951
 Web: www.envirocheck.co.uk

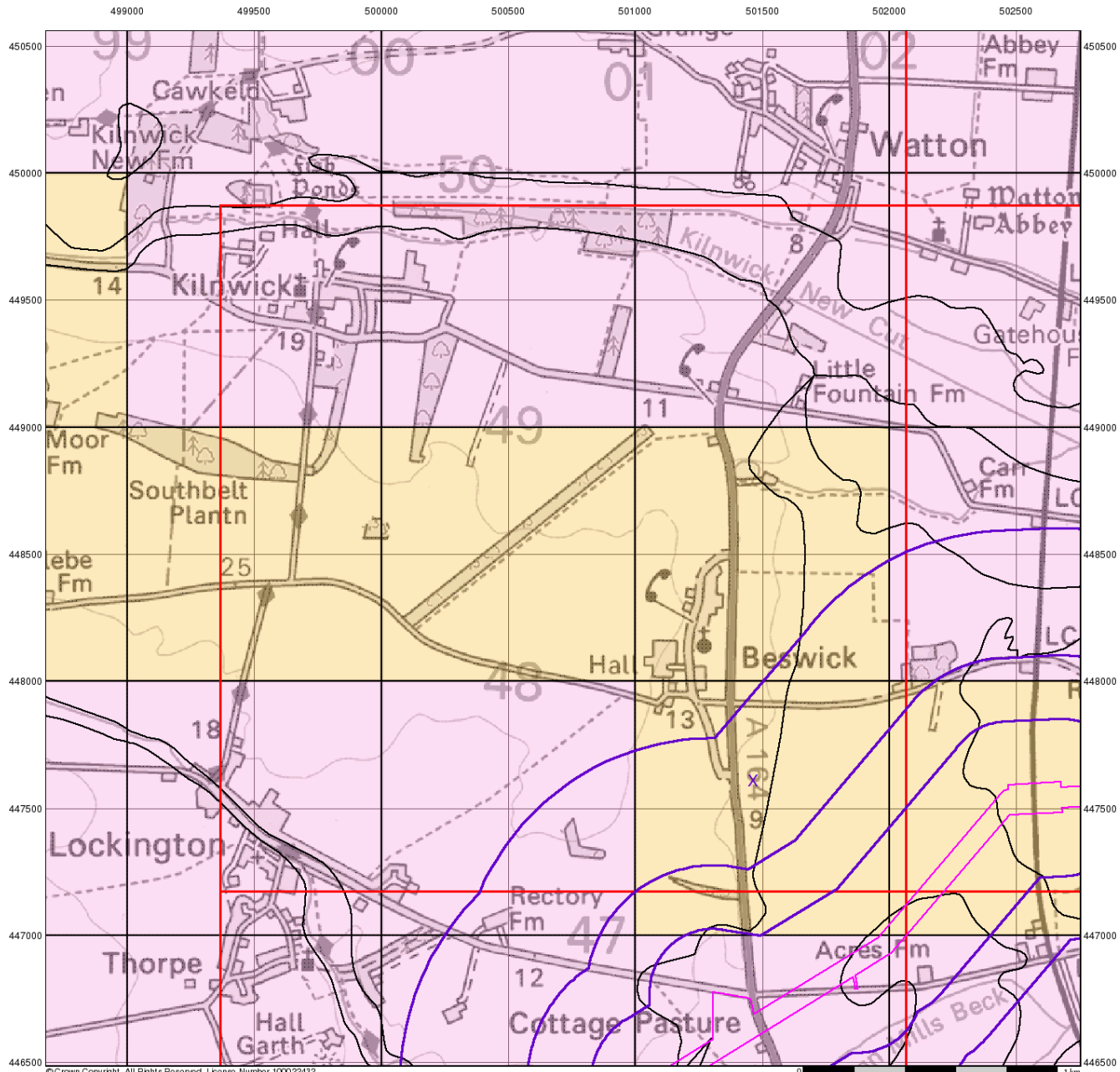

© Crown Copyright. All Rights Reserved. License Number 100022432.

Envirocheck®

LANDMARK INFORMATION GROUP®

Groundwater Vulnerability

General

- ◇ Specified Site
- ◇ Specified Buffer(s)
- X Bearing Reference Point
- Slice
- Map ID

Agency and Hydrological

Bedrock Aquifers

- High Vulnerability, Principal Aquifer
- High Vulnerability, Secondary Aquifer
- Medium Vulnerability, Principal Aquifer
- Medium Vulnerability, Secondary Aquifer
- Low Vulnerability, Principal Aquifer
- Low Vulnerability, Secondary Aquifer

Superficial Aquifers

- High Vulnerability, Principal Aquifer
- High Vulnerability, Secondary Aquifer
- Medium Vulnerability, Principal Aquifer
- Medium Vulnerability, Secondary Aquifer
- Low Vulnerability, Principal Aquifer
- Low Vulnerability, Secondary Aquifer

Unproductive Aquifer

Soluble Rock

Site Sensitivity Context Map - Slice C

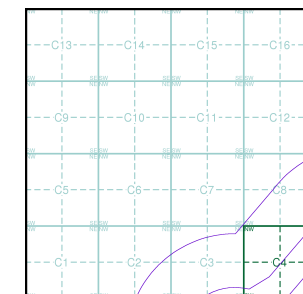

Order Details

Order Number: 201127555_1_1
 Customer Ref: PB8783-103-105
 National Grid Reference: 501460, 447610
 Slice: C
 Site Area (Ha): 62.79
 Search Buffer (m): 1000

Site Details

Hornsea Route

Landmark
 INFORMATION GROUP

Tel: 0844 844 9952
 Fax: 0844 844 9951
 Web: www.envirocheck.co.uk

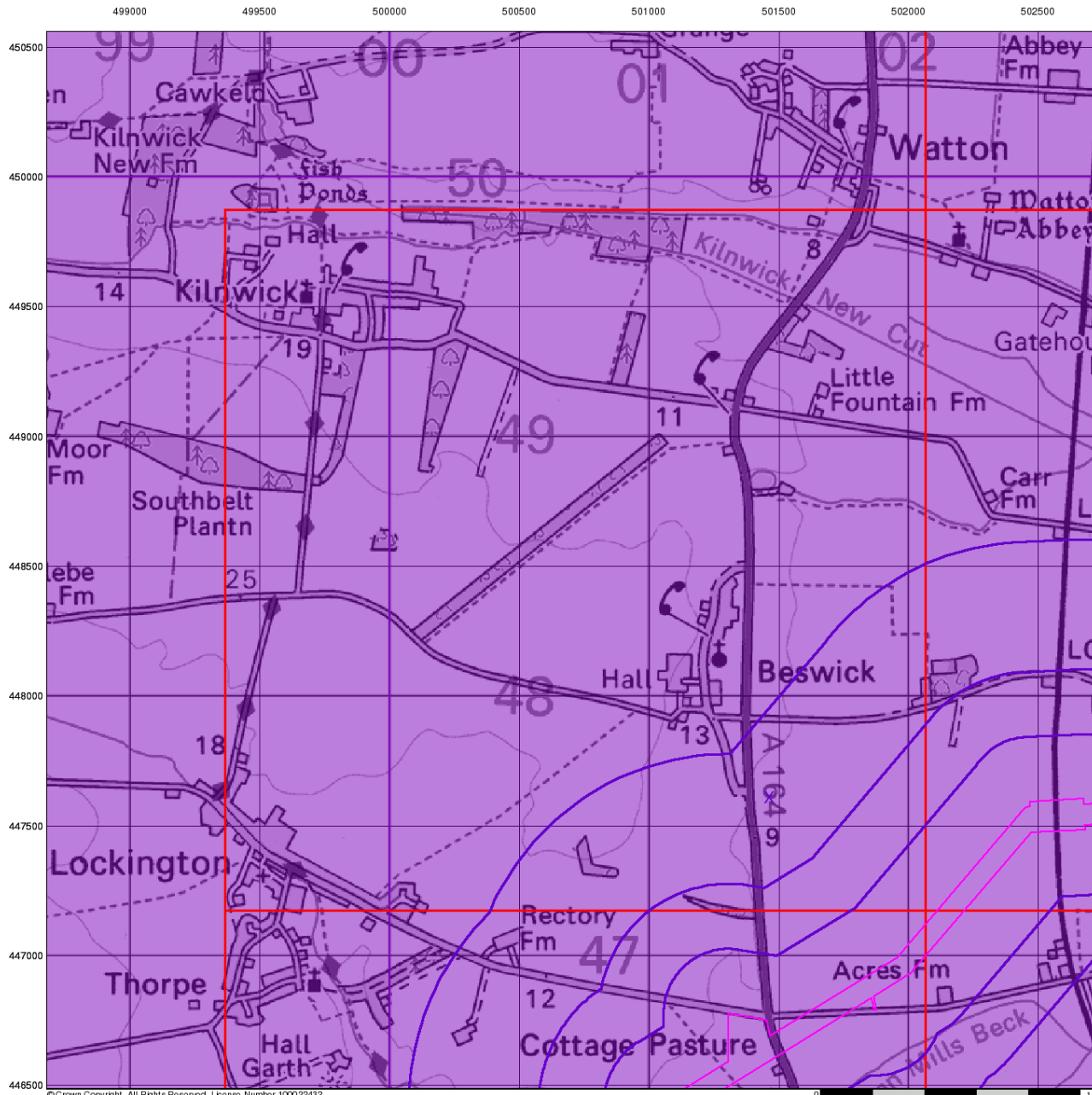

© Crown Copyright. All Rights Reserved. License Number 100022432.

0 1 km

Envirocheck[®]

● LANDMARK INFORMATION GROUP[®]

Bedrock Aquifer Designation

General

- ◇ Specified Site
- ◇ Specified Buffer(s)
- X Bearing Reference Point
- Slice
- B Map ID

Agency and Hydrological

Geological Classes

- Principal Aquifer
- Secondary A Aquifer
- Secondary B Aquifer
- Secondary Undifferentiated
- Unproductive Strata
- Unknown
- Unknown (Lakes and Landslip)

Site Sensitivity Context Map - Slice C

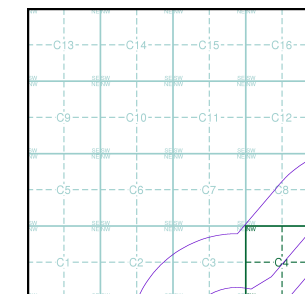

Order Details

Order Number: 201127555_1_1
 Customer Ref: PB8783-103-105
 National Grid Reference: 501460, 447610
 Slice: C
 Site Area (Ha): 62.79
 Search Buffer (m): 1000

Site Details

Hornsea Route

Landmark[®]
 ● LANDMARK INFORMATION GROUP

Tel: 0844 844 9952
 Fax: 0844 844 9951
 Web: www.envirocheck.co.uk

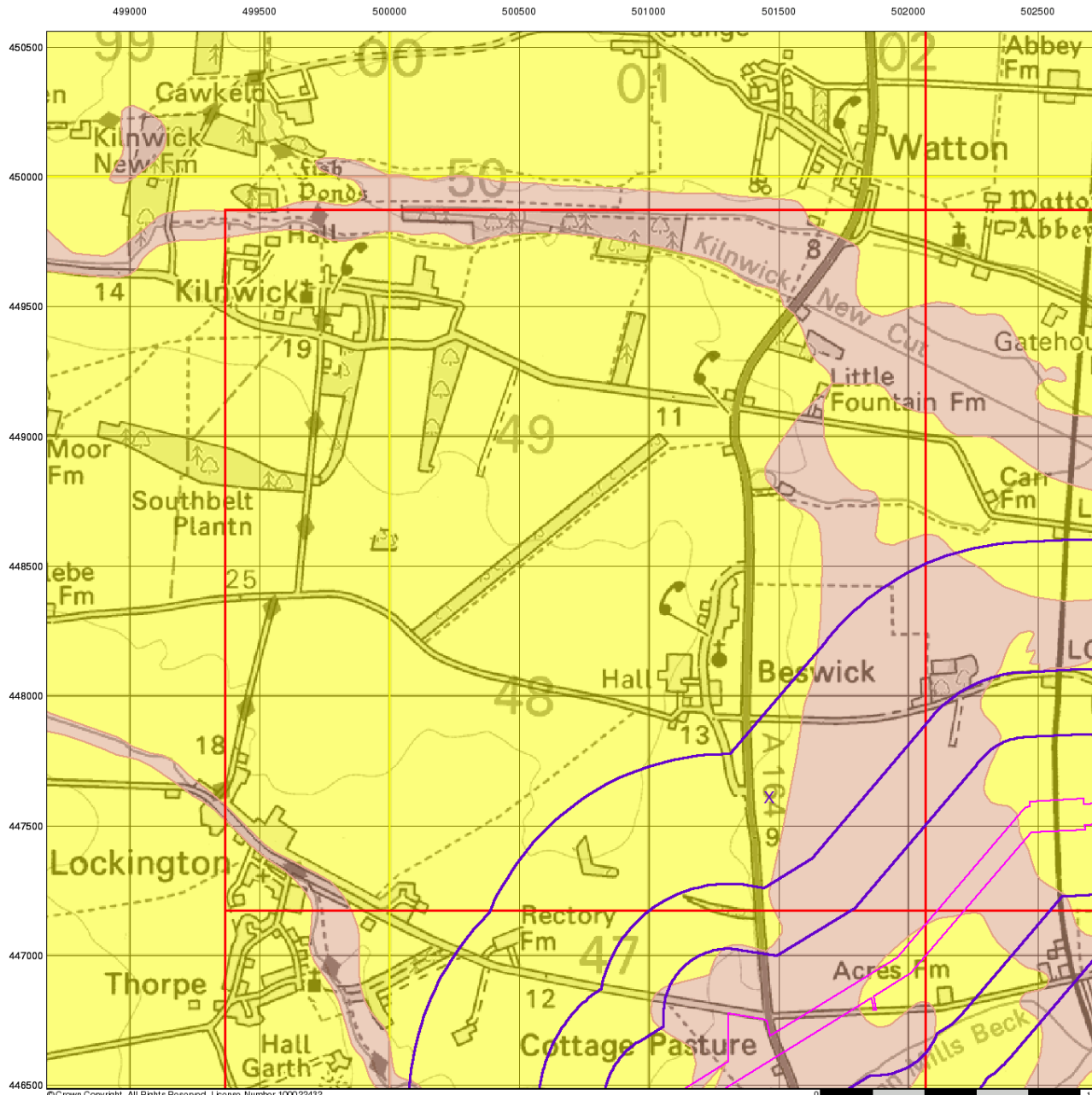

© Crown Copyright. All Rights Reserved. License Number 100022432.

Envirocheck[®]

● LANDMARK INFORMATION GROUP[®]

Superficial Aquifer Designation

General

- Specified Site
- Specified Buffer(s)
- Bearing Reference Point
- Slice
- Map ID

Agency and Hydrological

Geological Classes

- Principal Aquifer
- Secondary A Aquifer
- Secondary B Aquifer
- Secondary Undifferentiated
- Unproductive Strata
- Unknown
- Unknown (Lakes and Landslip)

Site Sensitivity Context Map - Slice C

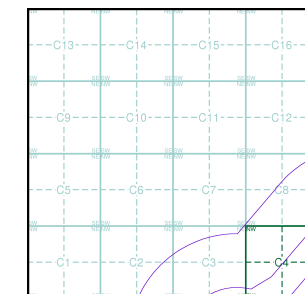

Order Details

Order Number: 201127555_1_1
 Customer Ref: PB8783-103-105
 National Grid Reference: 501460, 447610
 Slice: C
 Site Area (Ha): 62.79
 Search Buffer (m): 1000

Site Details

Hornsea Route

Landmark[®]
 ● LANDMARK INFORMATION GROUP

Tel: 0844 844 9952
 Fax: 0844 844 9951
 Web: www.envirocheck.co.uk

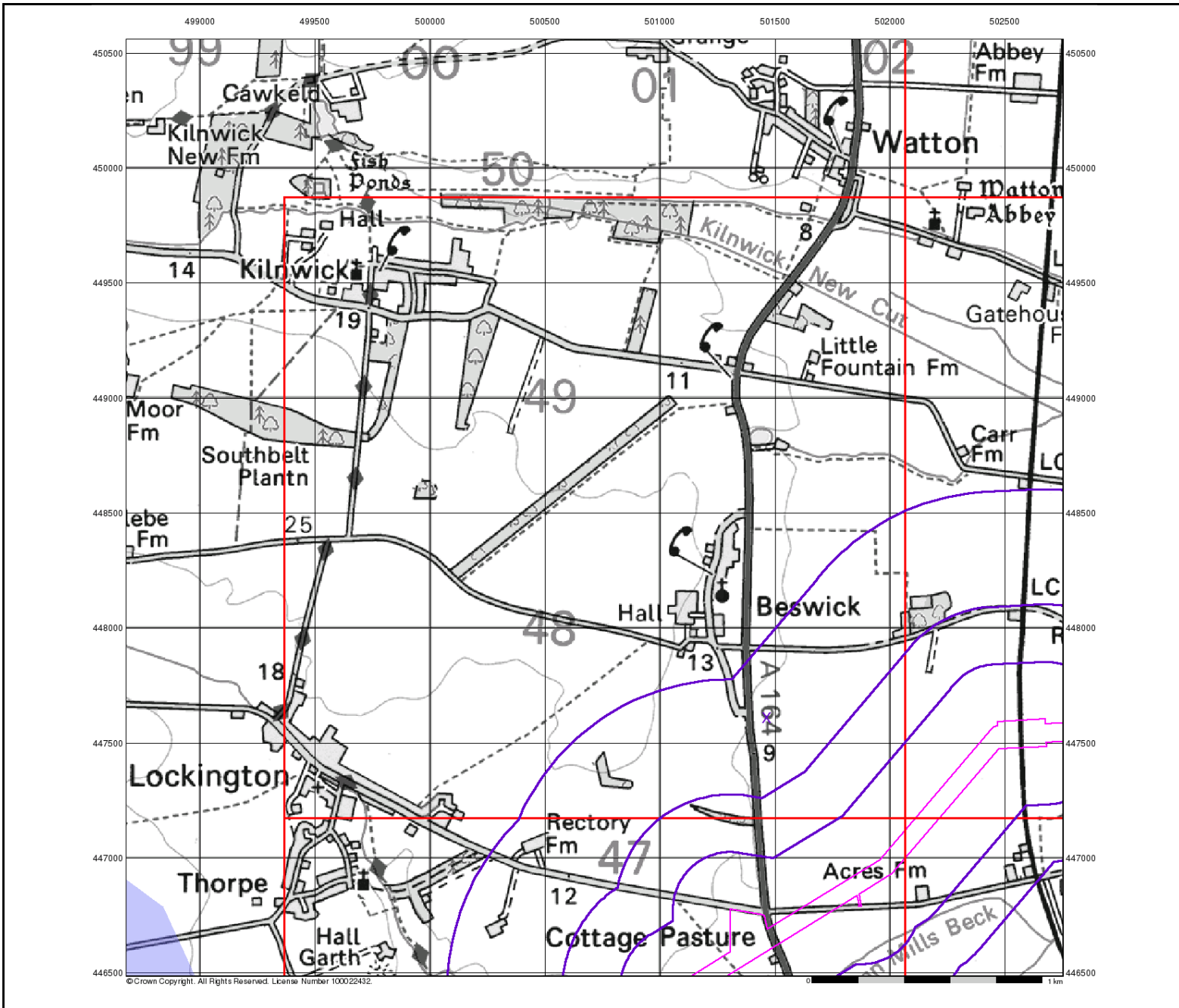

Envirocheck[®]

● LANDMARK INFORMATION GROUP[®]

Source Protection Zones

General

- Specified Site
- Specified Buffer(s)
- Bearing Reference Point
- Slice
- Map ID

Agency and Hydrological

- Inner zone (Zone 1)
- Inner zone - subsurface activity only (Zone 1c)
- Outer zone (Zone 2)
- Outer zone - subsurface activity only (Zone 2c)
- Total catchment (Zone 3)
- Total catchment - subsurface activity only (Zone 3c)
- Special interest (Zone 4)

Site Sensitivity Context Map - Slice C

Order Details

Order Number:	201127555_1_1
Customer Ref:	PB8783-103-105
National Grid Reference:	501460, 447610
Slice:	C
Site Area (Ha):	62.79
Search Buffer (m):	1000

Site Details
Hornsea Route

Landmark[®]
● LANDMARK INFORMATION GROUP

Tel: 0844 844 9952
Fax: 0844 844 9951
Web: www.envirocheck.co.uk

A Landmark Information Group Service v15.0 17-Apr-2019 Page 4 of 6

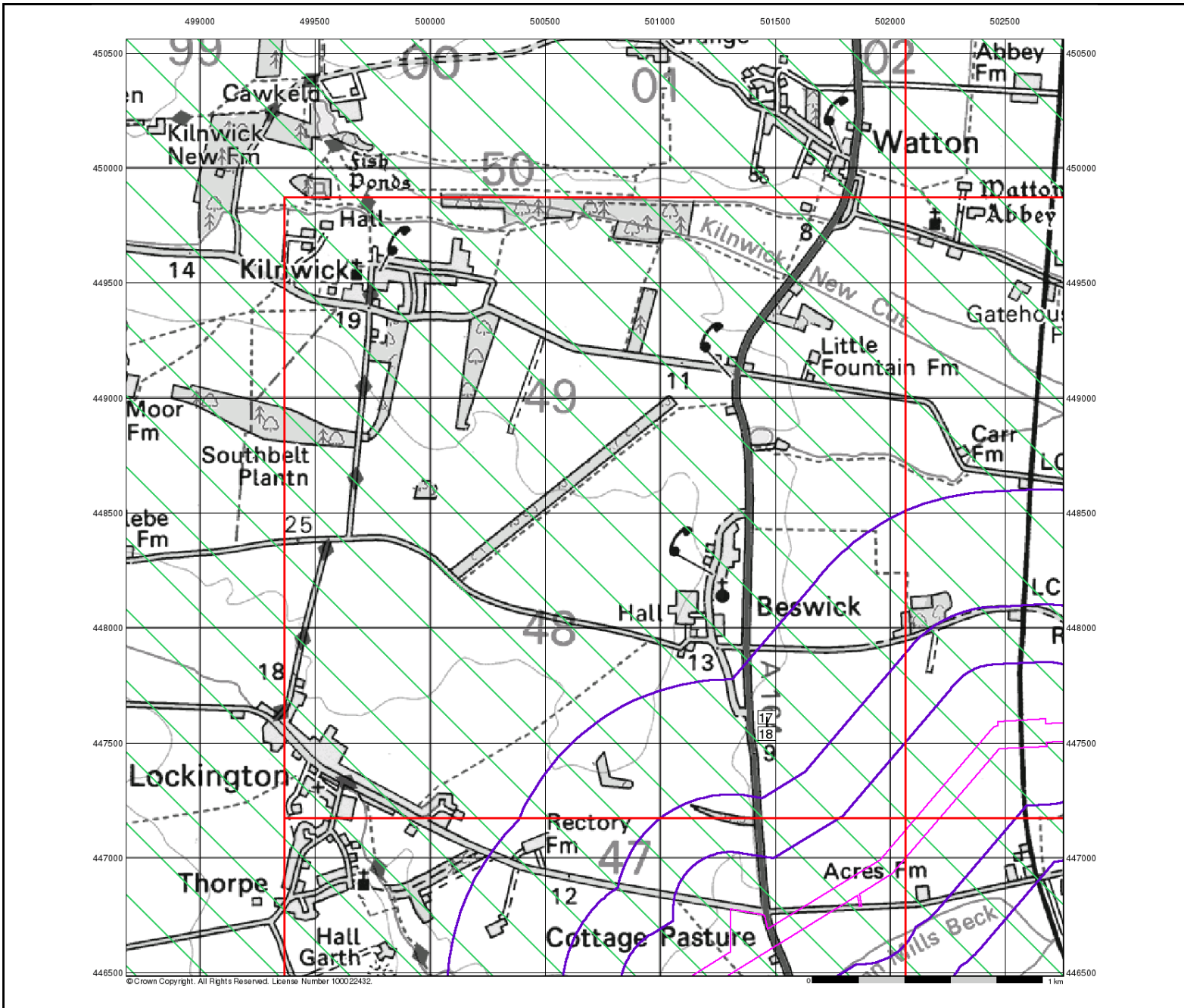

Envirocheck[®]

● LANDMARK INFORMATION GROUP[®]

Sensitive Land Uses

General

- ◇ Specified Site
- ◊ Specified Buffer(s)
- X Bearing Reference Point
- Slice
- B Map ID

Sensitive Land Uses

■ Ancient Woodland	N National Park
A Area of Adopted Green Belt	N Nitrate Sensitive Area
A Area of Unadopted Green Belt	N Nitrate Vulnerable Zone
A Area of Outstanding Natural Beauty	N Ramsar Site
A Environmentally Sensitive Area	N Site of Special Scientific Interest
A Forest Park	N Special Area of Conservation
A Local Nature Reserve	N Special Protection Area
A Marine Nature Reserve	A World Heritage Sites
A National Nature Reserve	

Site Sensitivity Context Map - Slice C

Order Details

Order Number:	201127555_1_1
Customer Ref:	PB8783-103-105
National Grid Reference:	501460, 447610
Slice:	C
Site Area (Ha):	62.79
Search Buffer (m):	1000

Site Details
Hornsea Route

Landmark[®]
● LANDMARK INFORMATION GROUP

Tel: 0844 844 9952
Fax: 0844 844 9951
Web: www.envirocheck.co.uk

A Landmark Information Group Service v15.0 17-Apr-2019 Page 5 of 6

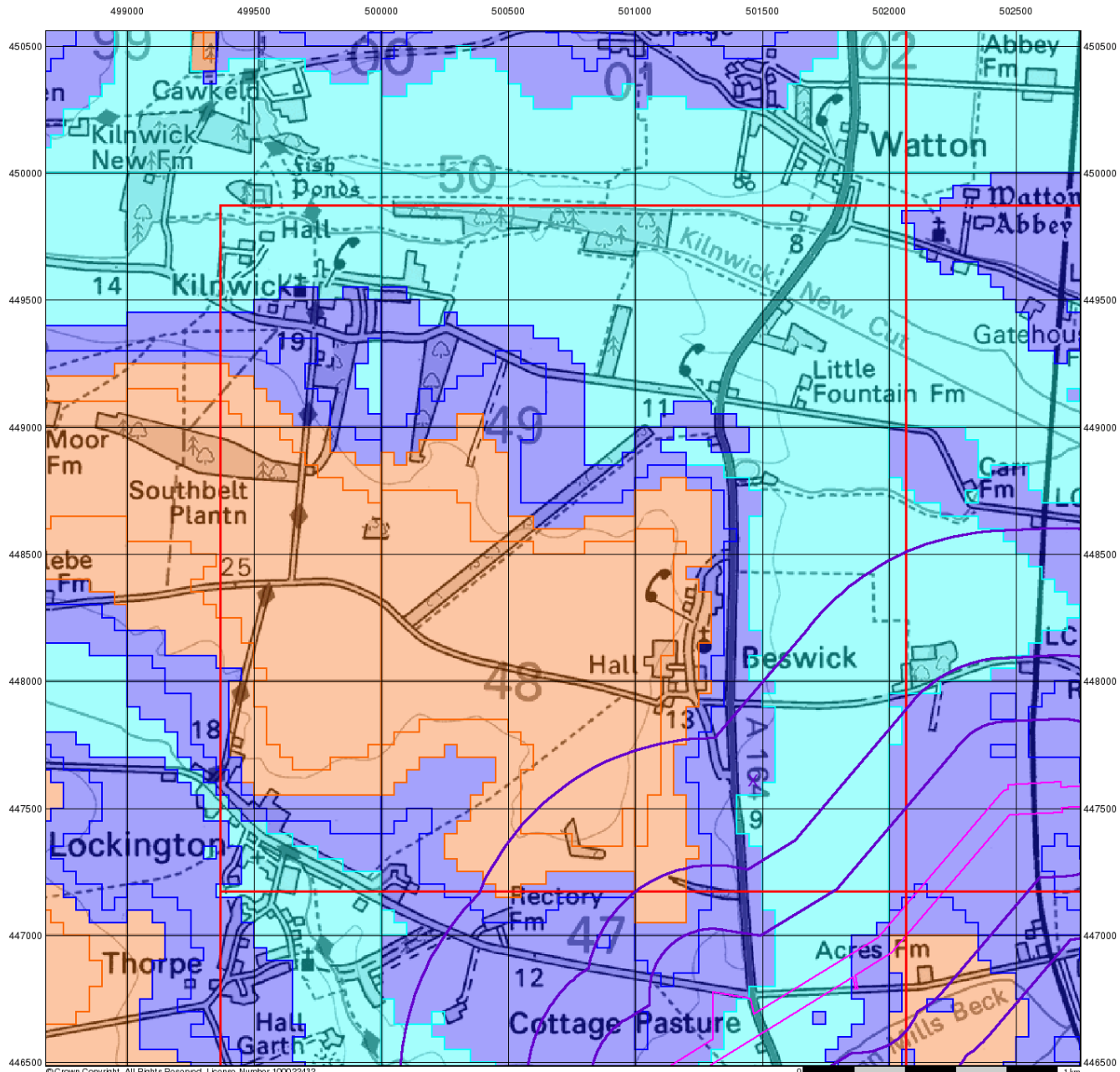

© Crown Copyright. All Rights Reserved. License Number 100022432.

Envirocheck®

LANDMARK INFORMATION GROUP®

BGS Flood GFS Data

General

- Specified Site
- Specified Buffer(s)
- Bearing Reference Point
- Slice

Agency and Hydrological (Flood)

- Limited Potential for Groundwater Flooding to Occur
- Potential for Groundwater Flooding of Property Situated Below Ground Level
- Potential for Groundwater Flooding to Occur at Surface

Site Sensitivity Context Map - Slice C

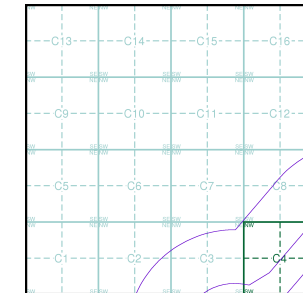

Order Details

Order Number: 201127555_1_1
 Customer Ref: PB8783-103-105
 National Grid Reference: 501460, 447610
 Slice: C
 Site Area (Ha): 62.79
 Search Buffer (m): 1000

Site Details

Hornsea Route

Landmark®
 LANDMARK INFORMATION GROUP

Tel: 0844 844 9952
 Fax: 0844 844 9951
 Web: www.envirocheck.co.uk

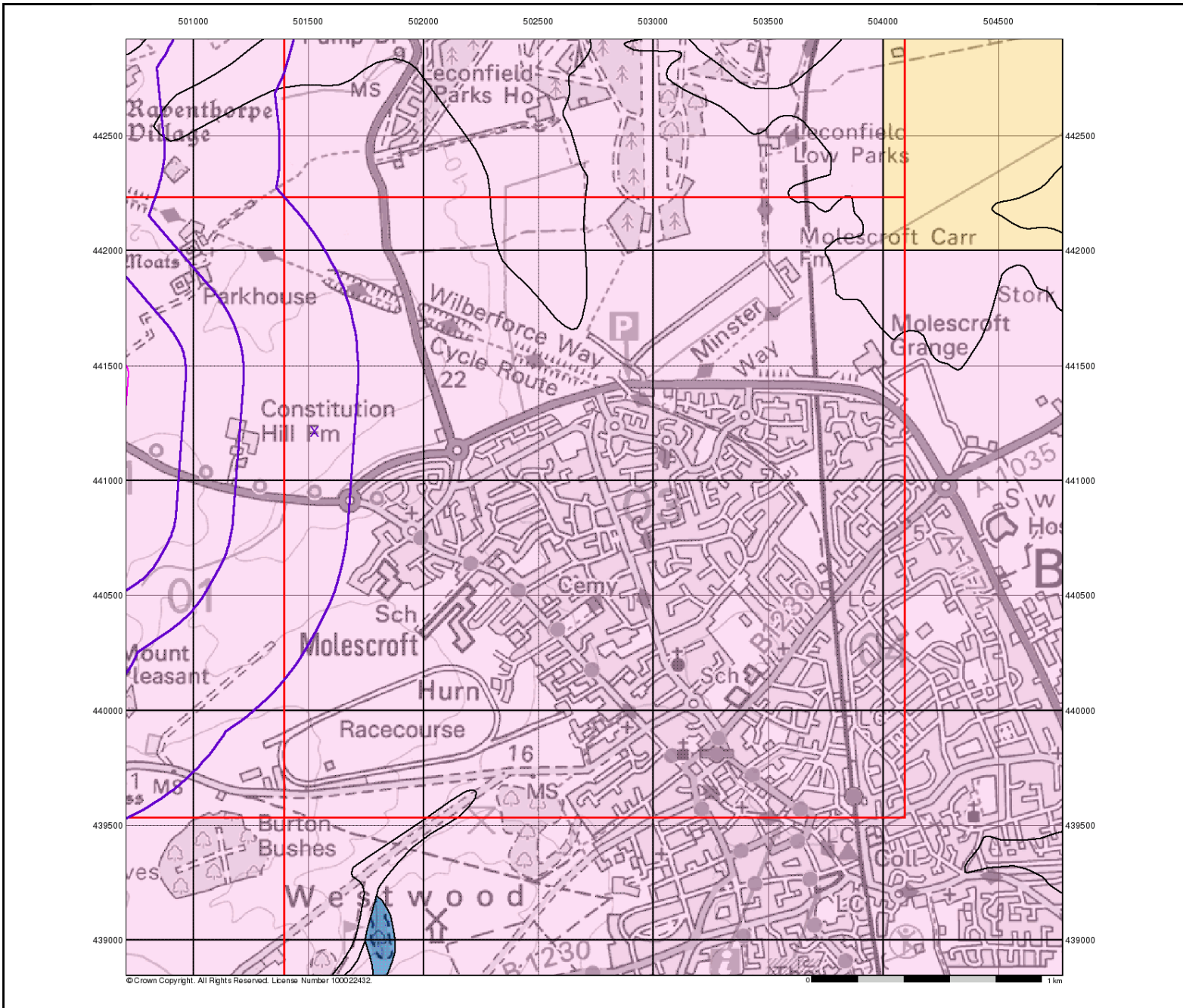

Envirocheck®

LANDMARK INFORMATION GROUP®

Groundwater Vulnerability

General

- Specified Site
- Specified Buffer(s)
- Bearing Reference Point
- Slice
- Map ID

Agency and Hydrological

Bedrock Aquifers		Superficial Aquifers	
High Vulnerability, Principal Aquifer	High Vulnerability, Secondary Aquifer	High Vulnerability, Principal Aquifer	High Vulnerability, Secondary Aquifer
Medium Vulnerability, Principal Aquifer	Medium Vulnerability, Secondary Aquifer	Medium Vulnerability, Principal Aquifer	Medium Vulnerability, Secondary Aquifer
Low Vulnerability, Principal Aquifer	Low Vulnerability, Secondary Aquifer	Low Vulnerability, Principal Aquifer	Low Vulnerability, Secondary Aquifer
Unproductive Aquifer	Soluble Rock		

Site Sensitivity Context Map - Slice C

Order Details

Order Number: 201127560_1_1
 Customer Ref: PB8783-103-105
 National Grid Reference: 501530, 441210
 Slice: C
 Site Area (Ha): 53.73
 Search Buffer (m): 1000

Site Details
 Hornsea Route

Landmark®
 INFORMATION GROUP

Tel: 0844 844 9952
 Fax: 0844 844 9951
 Web: www.envirocheck.co.uk

A Landmark Information Group Service v15.0 17-Apr-2019 Page 1 of 6

501000 501500 502000 502500 503000 503500 504000 504500

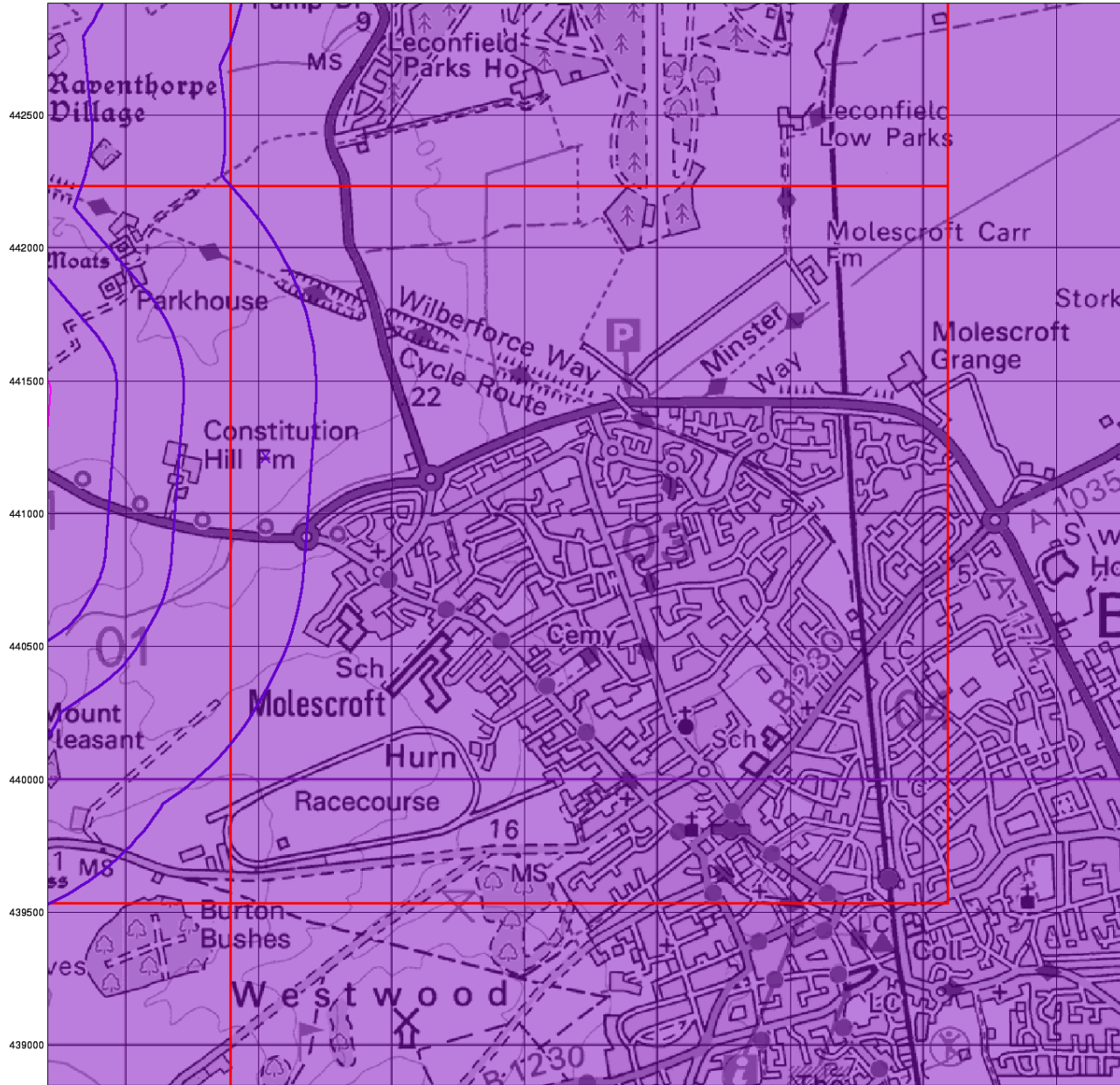

© Crown Copyright. All Rights Reserved. License Number 100022432.

0 1 km

Envirocheck®

● LANDMARK INFORMATION GROUP®

Bedrock Aquifer Designation

General

- Specified Site
- Specified Buffer(s)
- Bearing Reference Point
- Slice
- Map ID

Agency and Hydrological

Geological Classes

- Principal Aquifer
- Secondary A Aquifer
- Secondary B Aquifer
- Secondary Undifferentiated
- Unproductive Strata
- Unknown
- Unknown (Lakes and Landslip)

Site Sensitivity Context Map - Slice C

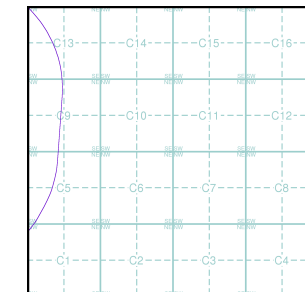

Order Details

Order Number: 201127560_1_1
 Customer Ref: PB8783-103-105
 National Grid Reference: 501530, 441210
 Slice: C
 Site Area (Ha): 53.73
 Search Buffer (m): 1000

Site Details

Hornsea Route

Landmark®
 ●●● INFORMATION GROUP

Tel: 0844 844 9952
 Fax: 0844 844 9951
 Web: www.envirocheck.co.uk

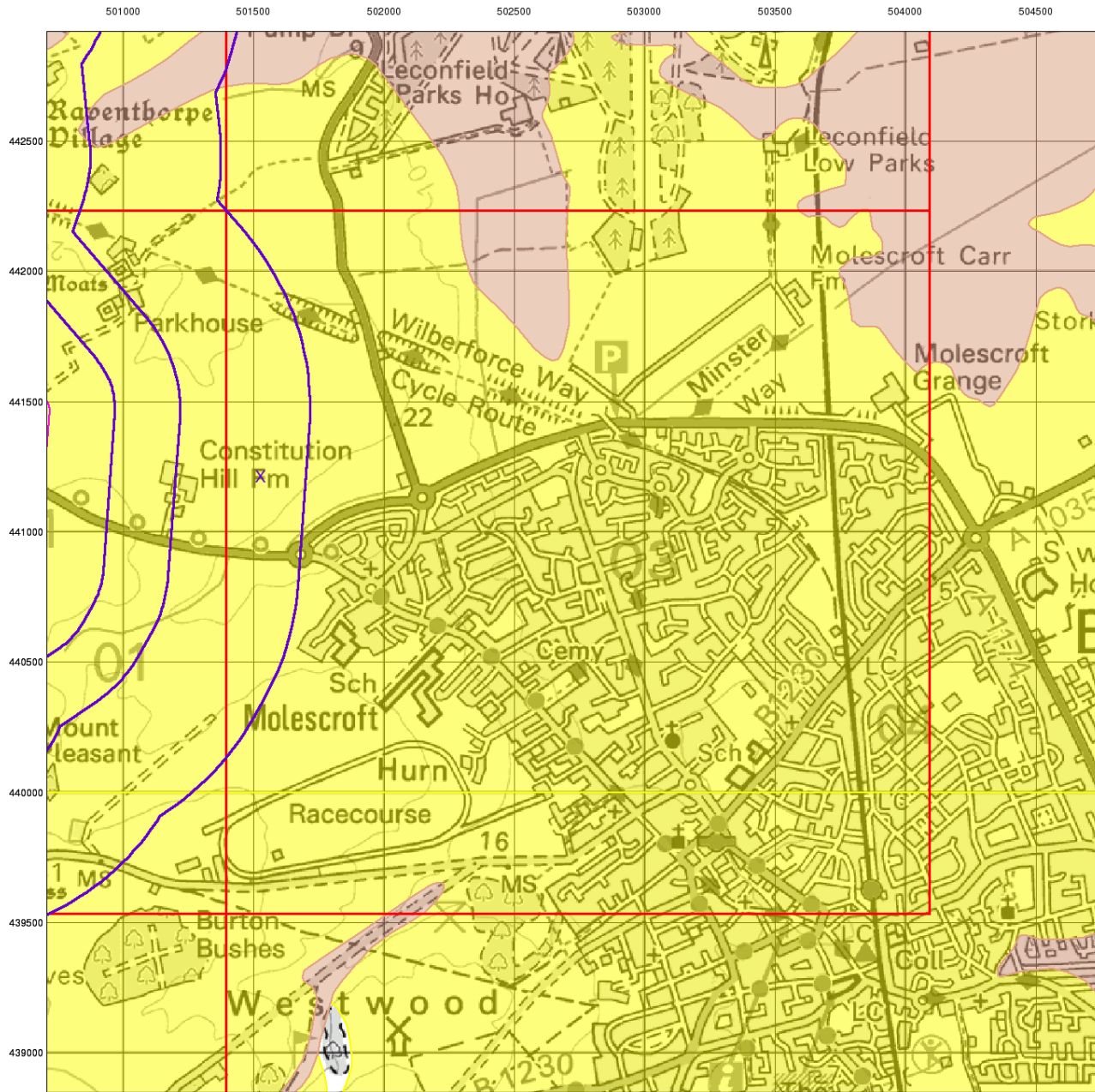

© Crown Copyright. All Rights Reserved. License Number 100022432.

0 1 km

Envirocheck[®]

LANDMARK INFORMATION GROUP[®]

Superficial Aquifer Designation

General

- Specified Site
- Specified Buffer(s)
- Bearing Reference Point
- Slice
- Map ID

Agency and Hydrological

Geological Classes

- Principal Aquifer
- Secondary A Aquifer
- Secondary B Aquifer
- Secondary Undifferentiated
- Unproductive Strata
- Unknown
- Unknown (Lakes and Landslip)

Site Sensitivity Context Map - Slice C

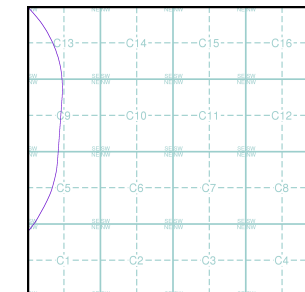

Order Details

Order Number: 201127560_1_1
 Customer Ref: PB8783-103-105
 National Grid Reference: 501530, 441210
 Slice: C
 Site Area (Ha): 53.73
 Search Buffer (m): 1000

Site Details

Hornsea Route

Landmark[®]
 LANDMARK INFORMATION GROUP

Tel: 0844 844 9952
 Fax: 0844 844 9951
 Web: www.envirocheck.co.uk

501000 501500 502000 502500 503000 503500 504000 504500



© Crown Copyright. All Rights Reserved. License Number 100022432.

0 1 km

Envirocheck®

● LANDMARK INFORMATION GROUP®

Source Protection Zones

General

- Specified Site
- Specified Buffer(s)
- Bearing Reference Point
- Slice
- Map ID

Agency and Hydrological

- Inner zone (Zone 1)
- Inner zone - subsurface activity only (Zone 1c)
- Outer zone (Zone 2)
- Outer zone - subsurface activity only (Zone 2c)
- Total catchment (Zone 3)
- Total catchment - subsurface activity only (Zone 3c)
- Special interest (Zone 4)

Site Sensitivity Context Map - Slice C

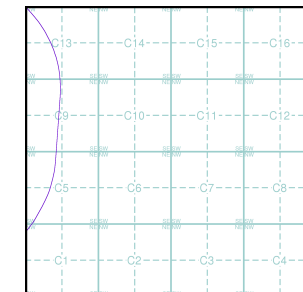

Order Details

Order Number: 201127560_1_1
 Customer Ref: PB8783-103-105
 National Grid Reference: 501530, 441210
 Slice: C
 Site Area (Ha): 53.73
 Search Buffer (m): 1000

Site Details

Hornsea Route

Landmark®
 ●●● INFORMATION GROUP

Tel: 0844 844 9952
 Fax: 0844 844 9951
 Web: www.envirocheck.co.uk

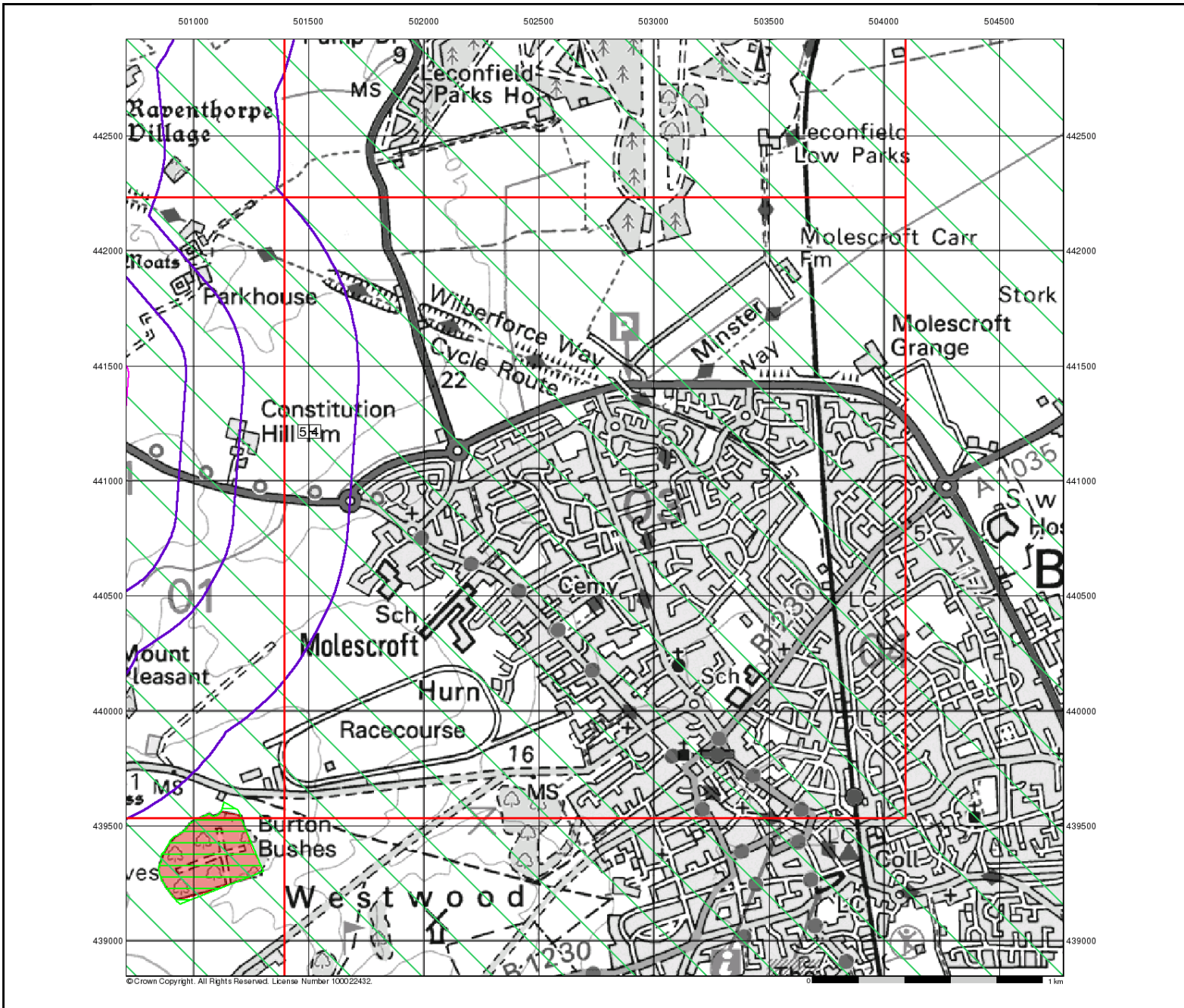

Envirocheck®

● LANDMARK INFORMATION GROUP®

Sensitive Land Uses

General

- Specified Site
- Specified Buffer(s)
- Bearing Reference Point
- Slice
- Map ID

Sensitive Land Uses

- Ancient Woodland
- Area of Adopted Green Belt
- Area of Unadopted Green Belt
- Area of Outstanding Natural Beauty
- Environmentally Sensitive Area
- Forest Park
- Local Nature Reserve
- Marine Nature Reserve
- National Nature Reserve
- National Park
- Nitrate Sensitive Area
- Nitrate Vulnerable Zone
- Ramsar Site
- Site of Special Scientific Interest
- Special Area of Conservation
- Special Protection Area
- World Heritage Sites

Site Sensitivity Context Map - Slice C

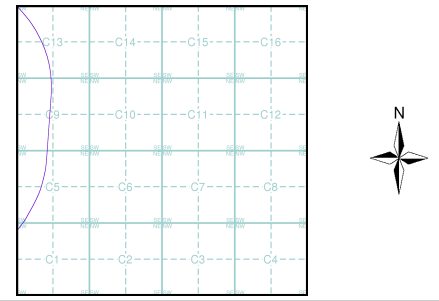

Order Details

Order Number: 201127560_1_1
 Customer Ref: PB8783-103-105
 National Grid Reference: 501530, 441210
 Slice: C
 Site Area (Ha): 53.73
 Search Buffer (m): 1000

Site Details

Hornsea Route

Landmark®
 ● LANDMARK INFORMATION GROUP

Tel: 0844 844 9952
 Fax: 0844 844 9951
 Web: www.envirocheck.co.uk

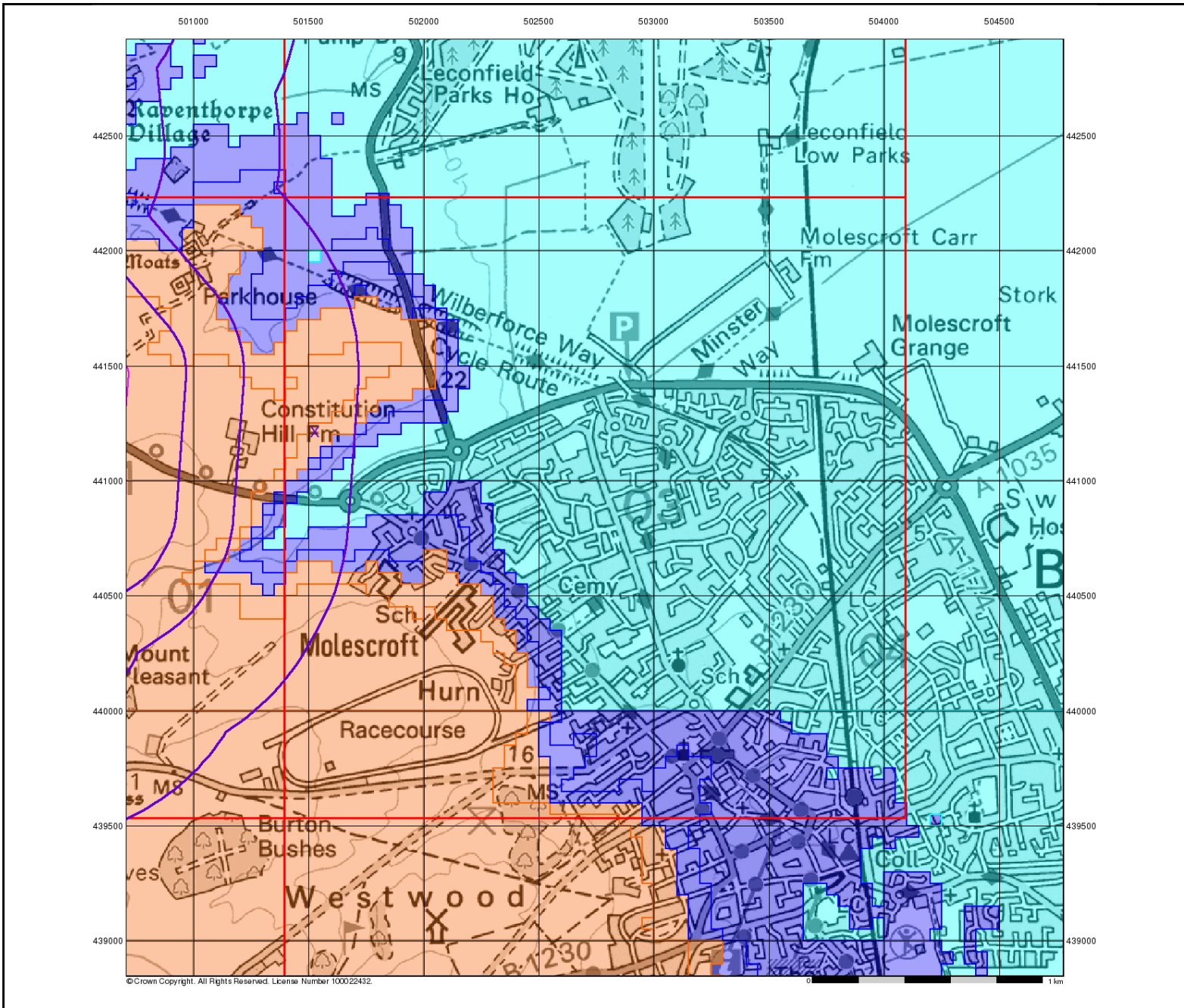

Envirocheck®

LANDMARK INFORMATION GROUP®

BGS Flood GFS Data

General

- Specified Site
- Specified Buffer(s)
- Bearing Reference Point
- Slice

Agency and Hydrological (Flood)

- Limited Potential for Groundwater Flooding to Occur
- Potential for Groundwater Flooding of Property Situated Below Ground Level
- Potential for Groundwater Flooding to Occur at Surface

Site Sensitivity Context Map - Slice C

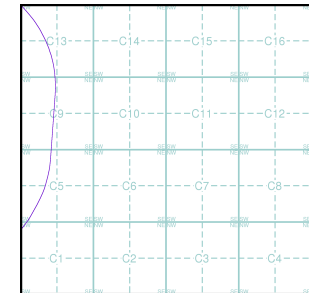

Order Details

Order Number: 201127560_1_1
 Customer Ref: PB8783-103-105
 National Grid Reference: 501530, 441210
 Slice: C
 Site Area (Ha): 53.73
 Search Buffer (m): 1000

Site Details

Hornsea Route

Landmark
 INFORMATION GROUP

Tel: 0844 844 9952
 Fax: 0844 844 9951
 Web: www.envirocheck.co.uk

© Crown Copyright. All Rights Reserved. License Number 100022432.

0 1 km

Historical Mapping Legends

Ordnance Survey County Series 1:10,560

	Gravel Pit		Sand Pit		Other Pits
	Quarry		Shingle		Orchard
	Osiers		Reeds		Marsh
	Mixed Wood		Deciduous		Brushwood
	Fir		Furze		Rough Pasture
	Arrow denotes flow of water		Trigonometrical Station		
	Site of Antiquities		Bench Mark		
	Pump, Guide Post, Signal Post		Well, Spring, Boundary Post		
	-285 Surface Level				
	Sketched Contour		Instrumental Contour		
	Main Roads		Minor Roads		
	Sunken Road		Raised Road		
	Road over Railway		Railway over River		
	Railway over Road		Level Crossing		
	Road over River or Canal		Road over Stream		
	Road over Stream				
	County Boundary (Geographical)				
	County & Civil Parish Boundary				
	Administrative County & Civil Parish Boundary				
	County Borough Boundary (England)				
	County Burgh Boundary (Scotland)				
	Rural District Boundary				
	Civil Parish Boundary				

Ordnance Survey Plan 1:10,000

	Chalk Pit, Clay Pit or Quarry		Gravel Pit
	Sand Pit		Disused Pit or Quarry
	Refuse or Slag Heap		Lake, Loch or Pond
	Dunes		Boulders
	Coniferous Trees		Non-Coniferous Trees
	Orchard		Scrub
	Coppice		Heath
	Rough Grassland		Marsh
	Reeds		Saltings
	Building		Glasshouse
	Sloping Masonry		Pylon
	Electricity Transmission Line		Pole
	Cutting		Embankment
	Standard Gauge Multiple Track		Standard Gauge Single Track
	Siding, Tramway or Mineral Line		Narrow Gauge
	Geographical County		
	Administrative County, County Borough or County of City		
	Municipal Borough, Urban or Rural District, Burgh or District Council		
	Borough, Burgh or County Constituency Shown only when not coincident with other boundaries		
	Civil Parish Shown alternately when coincidence of boundaries occurs		
	BP, BS Boundary Post or Stone		Pol Sta Police Station
	Ch Church		PO Post Office
	CH Club House		PC Public Convenience
	F E Sta Fire Engine Station		PH Public House
	FB Foot Bridge		SB Signal Box
	Fn Fountain		Spr Spring
	GP Guide Post		TCB Telephone Call Box
	MP Mile Post		TCP Telephone Call Post
	MS Mile Stone		W Well

1:10,000 Raster Mapping

	Gravel Pit		Refuse tip or slag heap
	Rock		Rock (scattered)
	Boulders		Boulders (scattered)
	Shingle		Mud
	Sand		Sand Pit
	Slopes		Top of cliff
	General detail		Underground detail
	Overhead detail		Narrow gauge railway
	Multi-track railway		Single track railway
	County boundary (England only)		Civil, parish or community boundary
	District, Unitary, Metropolitan, London Borough boundary		Constituency boundary
	Area of wooded vegetation		Non-coniferous trees
	Non-coniferous trees (scattered)		Coniferous trees
	Coniferous trees (scattered)		Positioned tree
	Orchard		Coppice or Osiers
	Rough Grassland		Heath
	Scrub		Marsh, Salt Marsh or Reeds
	Water feature		Flow arrows
	MHW(S) Mean high water (springs)		MLW(S) Mean low water (springs)
	Telephone line (where shown)		Electricity transmission line (with poles)
	Bench mark (where shown)		Triangulation station
	Point feature (e.g. Guide Post or Mile Stone)		Pylon, flare stack or lighting tower
	Site of (antiquity)		Glasshouse
	General Building		Important Building

Envirocheck®

LANDMARK INFORMATION GROUP®

Historical Mapping & Photography included:

Mapping Type	Scale	Date	Pg
Yorkshire	1:10,560	1854 - 1855	2
Yorkshire	1:10,560	1892 - 1894	3
Yorkshire	1:10,560	1911 - 1912	4
Yorkshire	1:10,560	1911	5
Yorkshire	1:10,560	1929	6
Yorkshire	1:10,560	1929	7
Yorkshire	1:10,560	1951	8
Ordnance Survey Plan	1:10,000	1956	9
Ordnance Survey Plan	1:10,000	1983	10
10K Raster Mapping	1:10,000	1999	11
Street View	Variable		12

Historical Map - Slice C

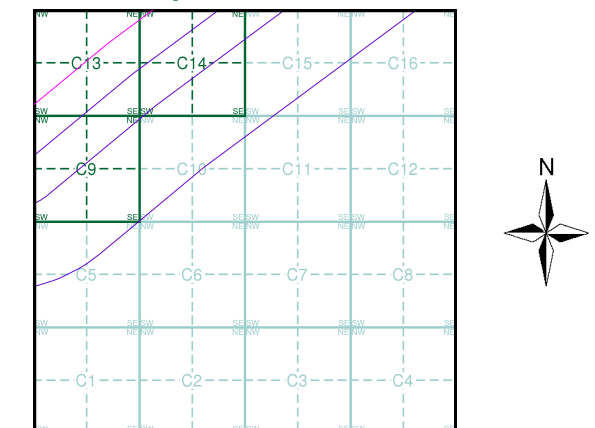

Order Details

Order Number: 201127462_1_1
 Customer Ref: PB8783-103-105
 National Grid Reference: 514690, 456000
 Slice: C
 Site Area (Ha): 2345.09
 Search Buffer (m): 1000

Site Details

Hornsea Route

Landmark
 INFORMATION GROUP

Tel: 0844 844 9952
 Fax: 0844 844 9951
 Web: www.envirocheck.co.uk

The historical maps shown were reproduced from maps predominantly held at the scale adopted for England, Wales and Scotland in the 1840's. In 1854 the 1:2,500 scale was adopted for mapping urban areas; these maps were used to update the 1:10,560 maps. The published date given therefore is often some years later than the surveyed date. Before 1938, all OS maps were based on the Cassini Projection, with independent surveys of a single county or group of counties, giving rise to significant inaccuracies in outlying areas. In the late 1940's, a Provisional Edition was produced, which updated the 1:10,560 mapping from a number of sources. The maps appear unfinished - with all military camps and other strategic sites removed. These maps were initially overprinted with the National Grid. In 1970, the first 1:10,000 maps were produced using the Transverse Mercator Projection. The revision process continued until recently, with new editions appearing every 10 years or so for urban areas.

Map Name(s) and Date(s)

16200 1854 1:10,560	16300 1854 1:10,560
17900 1854 1:10,560	18000 1855 1:10,560

Historical Map - Slice C

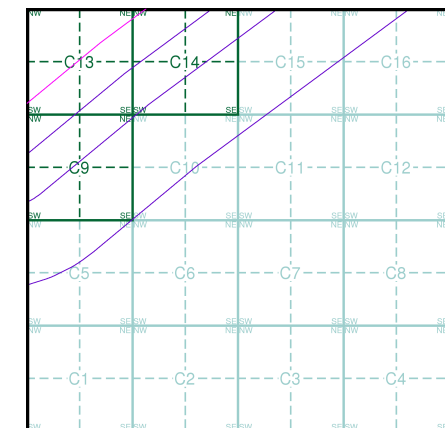

Order Details

Order Number: 201127462_1_1
 Customer Ref: PB8783-103-105
 National Grid Reference: 514690, 456000
 Slice: C
 Site Area (Ha): 2345.09
 Search Buffer (m): 1000

Site Details

Hornsea Route

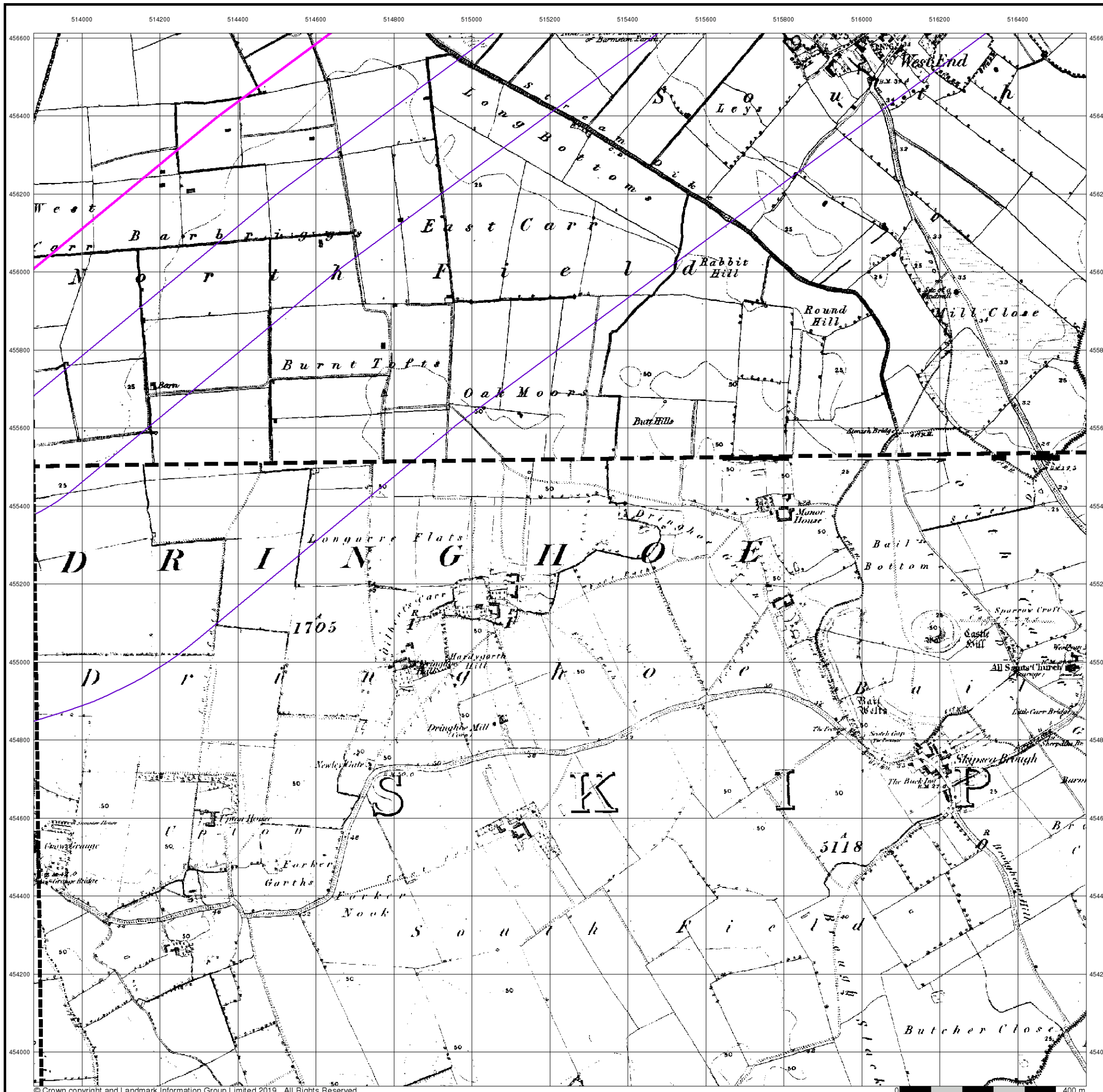

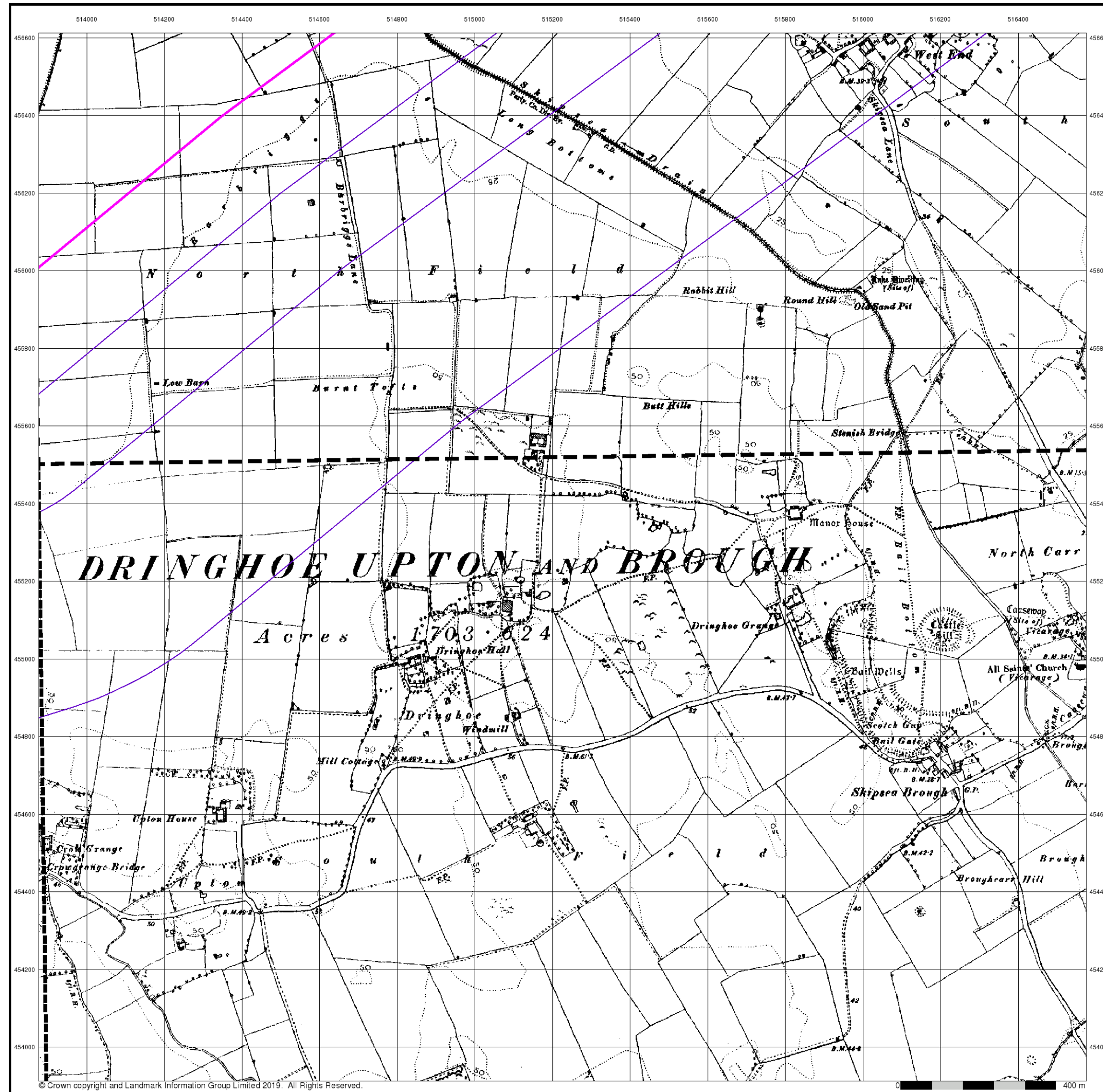

The historical maps shown were reproduced from maps predominantly held at the scale adopted for England, Wales and Scotland in the 1840's. In 1854 the 1:2,500 scale was adopted for mapping urban areas; these maps were used to update the 1:10,560 maps. The published date given therefore is often some years later than the surveyed date. Before 1938, all OS maps were based on the Cassini Projection, with independent surveys of a single county or group of counties, giving rise to significant inaccuracies in outlying areas. In the late 1940's, a Provisional Edition was produced, which updated the 1:10,560 mapping from a number of sources. The maps appear unfinished - with all military camps and other strategic sites removed. These maps were initially overprinted with the National Grid. In 1970, the first 1:10,000 maps were produced using the Transverse Mercator Projection. The revision process continued until recently, with new editions appearing every 10 years or so for urban areas.

Map Name(s) and Date(s)

162SE 1892 1:10,560	163SW 1893 1:10,560
179NE 1894 1:10,560	180NW 1892 1:10,560

Historical Map - Slice C

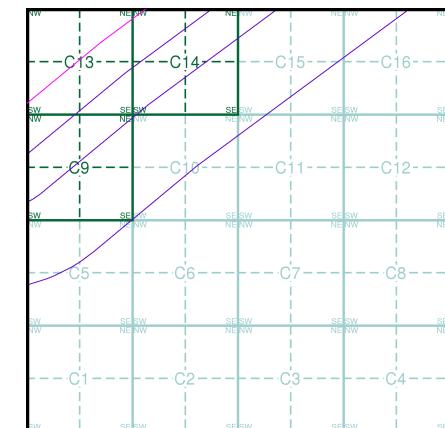

Order Details

Order Number: 201127462_1_1
 Customer Ref: PB8783-103-105
 National Grid Reference: 514690, 456000
 Slice: C
 Site Area (Ha): 2345.09
 Search Buffer (m): 1000

Site Details

Hornsea Route

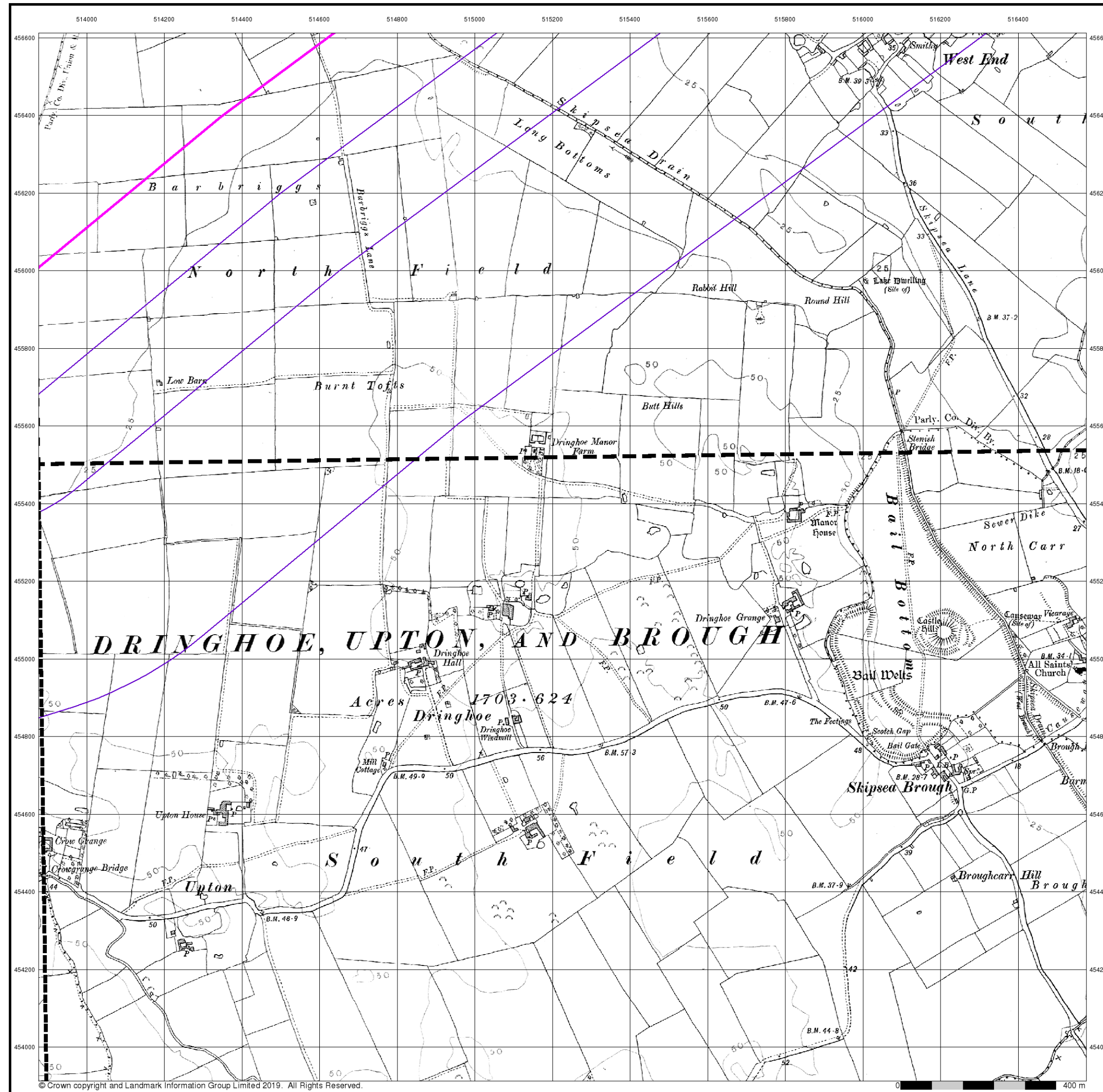

Yorkshire
Published 1911 - 1912
Source map scale - 1:10,560

The historical maps shown were reproduced from maps predominantly held at the scale adopted for England, Wales and Scotland in the 1840's. In 1854 the 1:2,500 scale was adopted for mapping urban areas; these maps were used to update the 1:10,560 maps. The published date given therefore is often some years later than the surveyed date. Before 1938, all OS maps were based on the Cassini Projection, with independent surveys of a single county or group of counties, giving rise to significant inaccuracies in outlying areas. In the late 1940's, a Provisional Edition was produced, which updated the 1:10,560 mapping from a number of sources. The maps appear unfinished - with all military camps and other strategic sites removed. These maps were initially overprinted with the National Grid. In 1970, the first 1:10,000 maps were produced using the Transverse Mercator Projection. The revision process continued until recently, with new editions appearing every 10 years or so for urban areas.

Map Name(s) and Date(s)

162SE 1912 1:10,560	163SW 1911 1:10,560
179NE 1911 1:10,560	180NW 1911 1:10,560

Historical Map - Slice C

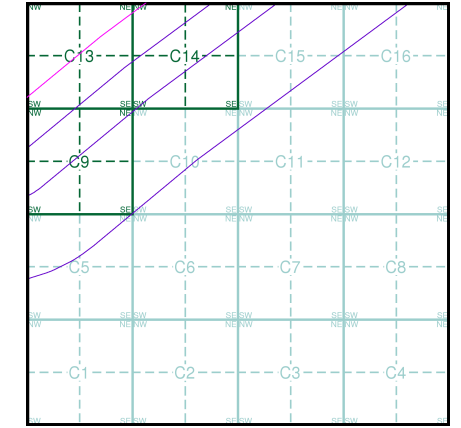

Order Details
 Order Number: 201127462_1_1
 Customer Ref: PB8783-103-105
 National Grid Reference: 514690, 456000
 Slice: C
 Site Area (Ha): 2345.09
 Search Buffer (m): 1000

Site Details
 Hornsea Route

Yorkshire

Published 1911

Source map scale - 1:10,560

The historical maps shown were reproduced from maps predominantly held at the scale adopted for England, Wales and Scotland in the 1840's. In 1854 the 1:2,500 scale was adopted for mapping urban areas; these maps were used to update the 1:10,560 maps. The published date given therefore is often some years later than the surveyed date. Before 1938, all OS maps were based on the Cassini Projection, with independent surveys of a single county or group of counties, giving rise to significant inaccuracies in outlying areas. In the late 1940's, a Provisional Edition was produced, which updated the 1:10,560 mapping from a number of sources. The maps appear unfinished - with all military camps and other strategic sites removed. These maps were initially overprinted with the National Grid. In 1970, the first 1:10,000 maps were produced using the Transverse Mercator Projection. The revision process continued until recently, with new editions appearing every 10 years or so for urban areas.

Map Name(s) and Date(s)

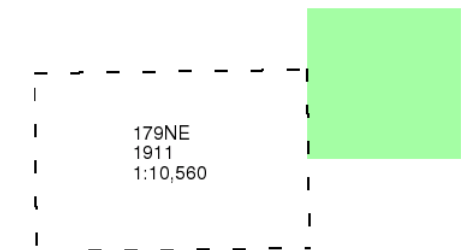

Historical Map - Slice C

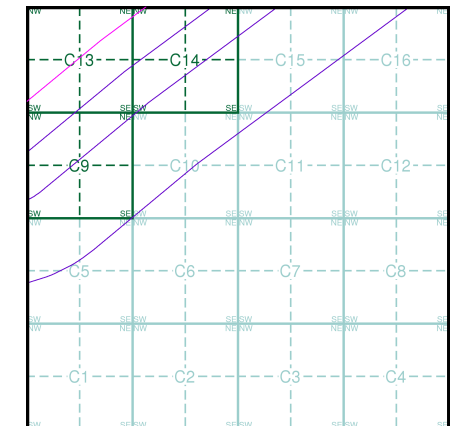

Order Details

Order Number: 201127462_1_1
Customer Ref: PB8783-103-105
National Grid Reference: 514690, 456000
Slice: C
Site Area (Ha): 2345.09
Search Buffer (m): 1000

Site Details

Hornsea Route

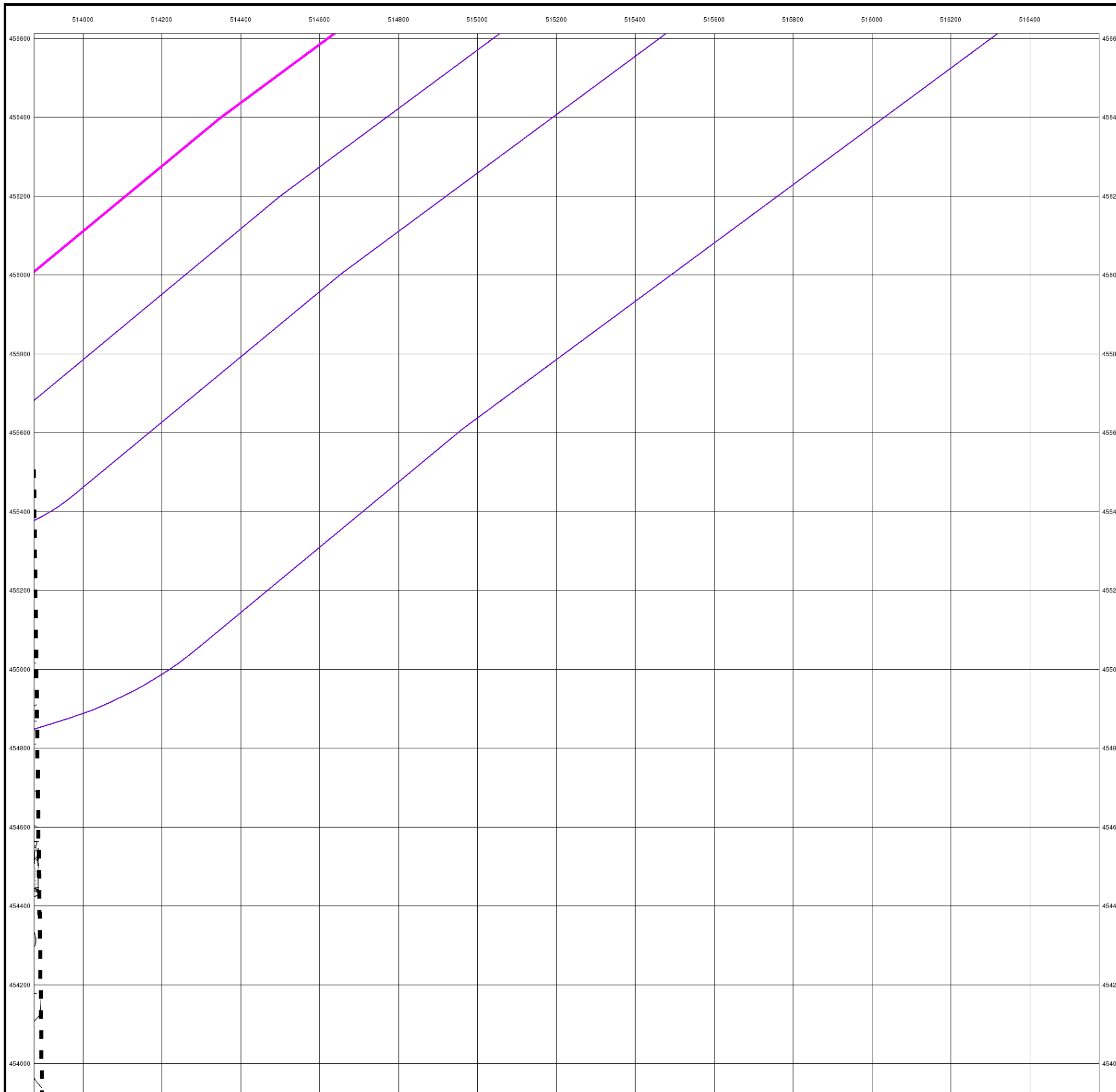

The historical maps shown were reproduced from maps predominantly held at the scale adopted for England, Wales and Scotland in the 1840's. In 1854 the 1:2,500 scale was adopted for mapping urban areas; these maps were used to update the 1:10,560 maps. The published date given therefore is often some years later than the surveyed date. Before 1938, all OS maps were based on the Cassini Projection, with independent surveys of a single county or group of counties, giving rise to significant inaccuracies in outlying areas. In the late 1940's, a Provisional Edition was produced, which updated the 1:10,560 mapping from a number of sources. The maps appear unfinished - with all military camps and other strategic sites removed. These maps were initially overprinted with the National Grid. In 1970, the first 1:10,000 maps were produced using the Transverse Mercator Projection. The revision process continued until recently, with new editions appearing every 10 years or so for urban areas.

Map Name(s) and Date(s)

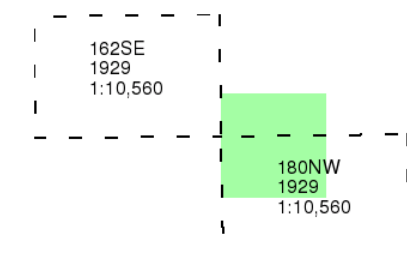

Historical Map - Slice C

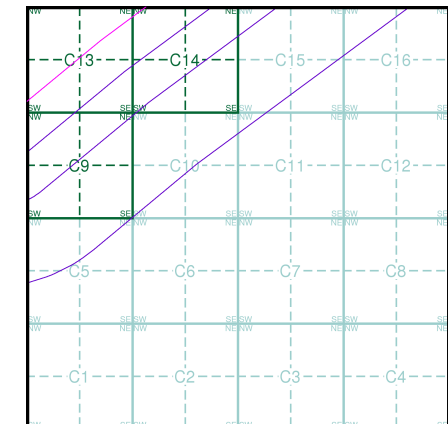

Order Details

Order Number: 201127462_1_1
 Customer Ref: PB8783-103-105
 National Grid Reference: 514690, 456000
 Slice: C
 Site Area (Ha): 2345.09
 Search Buffer (m): 1000

Site Details

Hornsea Route

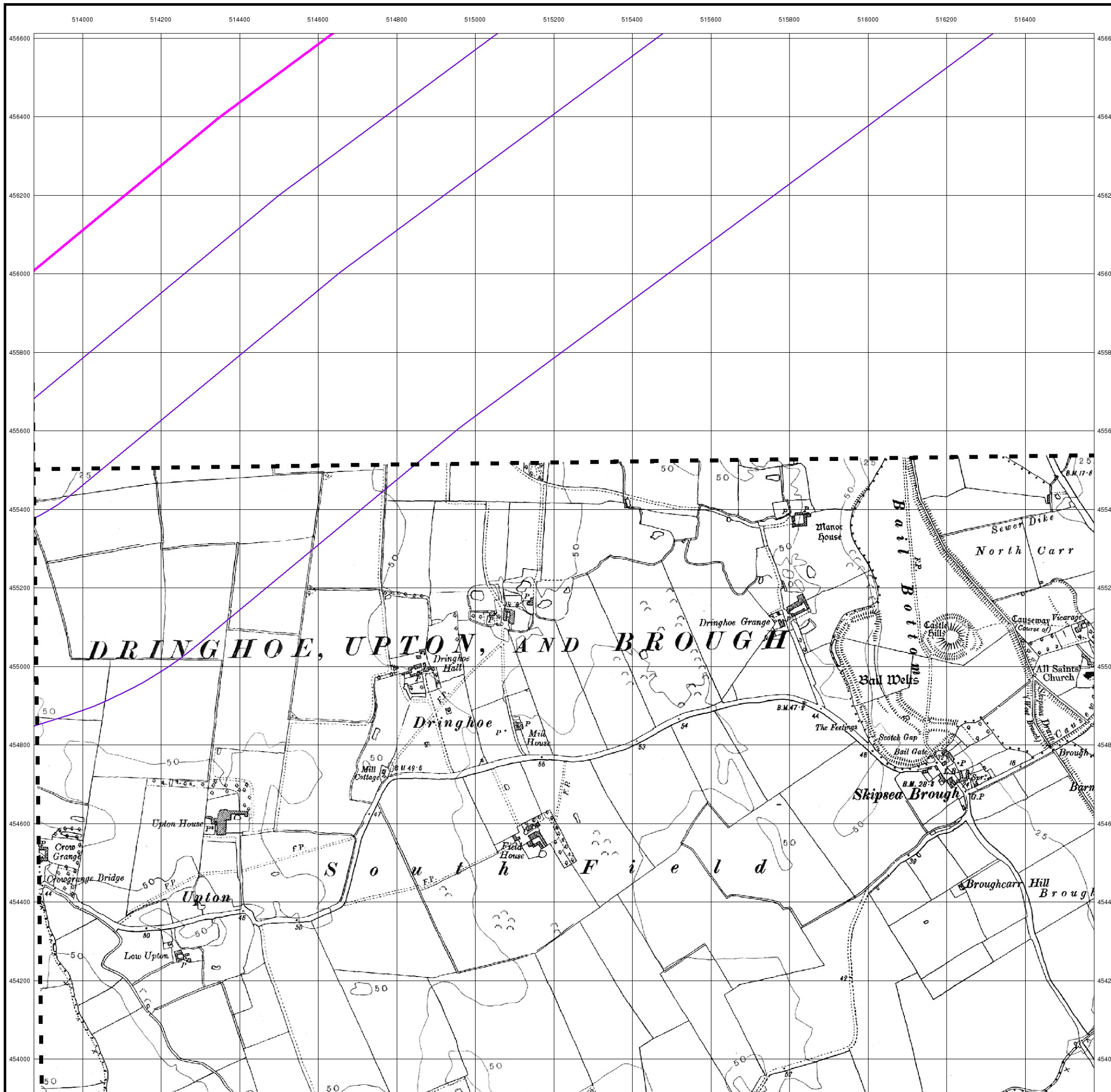

Yorkshire

Published 1929

Source map scale - 1:10,560

The historical maps shown were reproduced from maps predominantly held at the scale adopted for England, Wales and Scotland in the 1840's. In 1854 the 1:2,500 scale was adopted for mapping urban areas; these maps were used to update the 1:10,560 maps. The published date given therefore is often some years later than the surveyed date. Before 1938, all OS maps were based on the Cassini Projection, with independent surveys of a single county or group of counties, giving rise to significant inaccuracies in outlying areas. In the late 1940's, a Provisional Edition was produced, which updated the 1:10,560 mapping from a number of sources. The maps appear unfinished - with all military camps and other strategic sites removed. These maps were initially overprinted with the National Grid. In 1970, the first 1:10,000 maps were produced using the Transverse Mercator Projection. The revision process continued until recently, with new editions appearing every 10 years or so for urban areas.

Map Name(s) and Date(s)

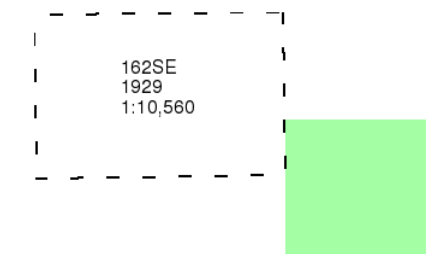

Historical Map - Slice C

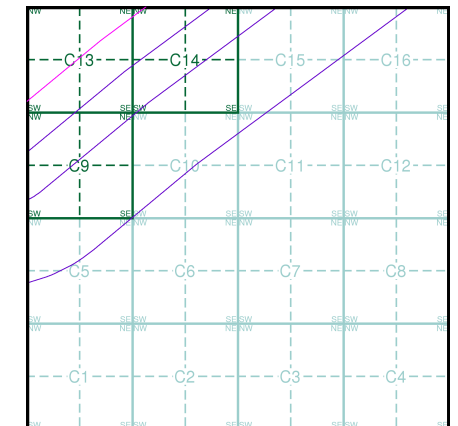

Order Details

Order Number: 201127462_1_1
 Customer Ref: PB8783-103-105
 National Grid Reference: 514690, 456000
 Slice: C
 Site Area (Ha): 2345.09
 Search Buffer (m): 1000

Site Details

Hornsea Route

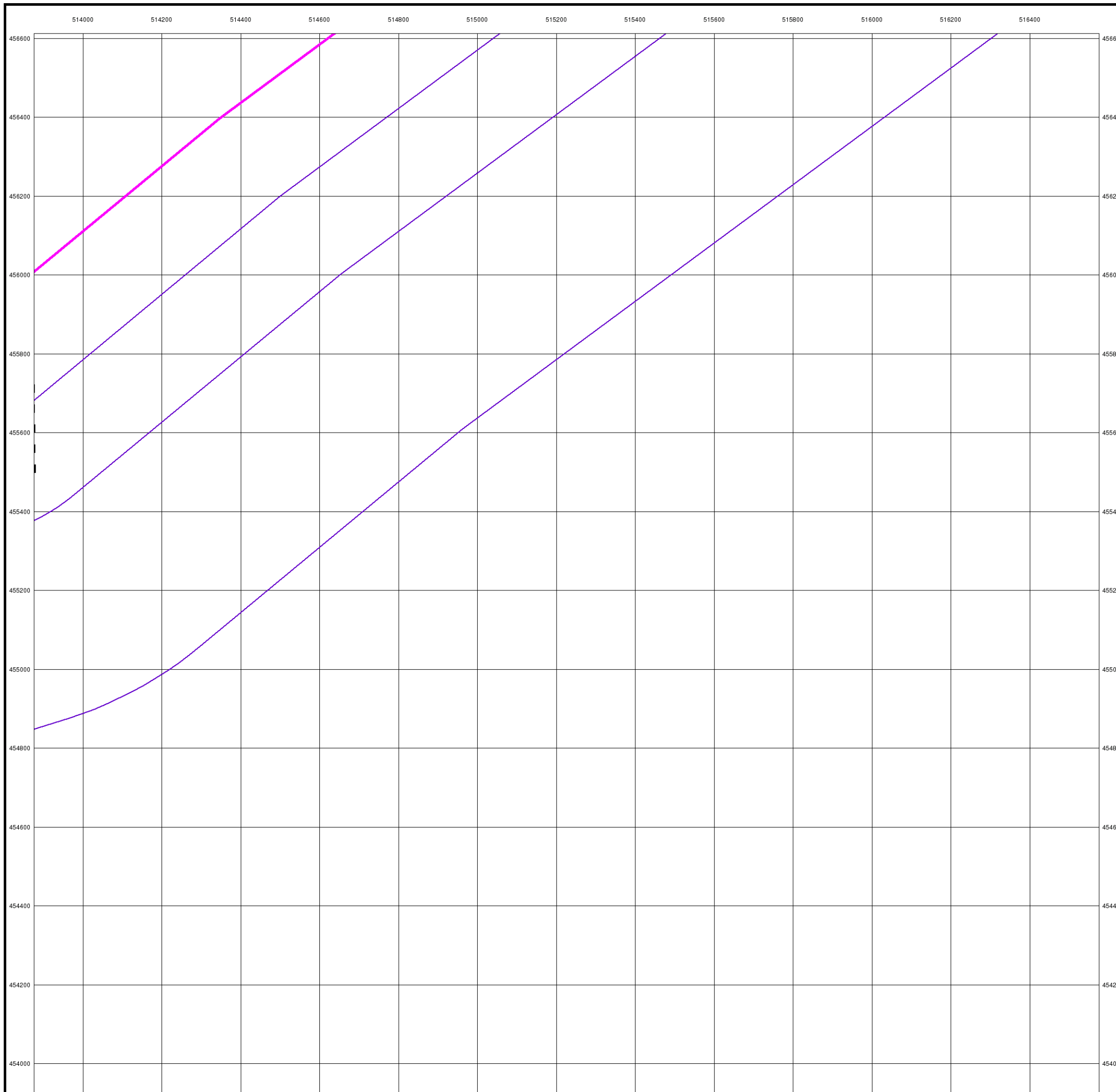

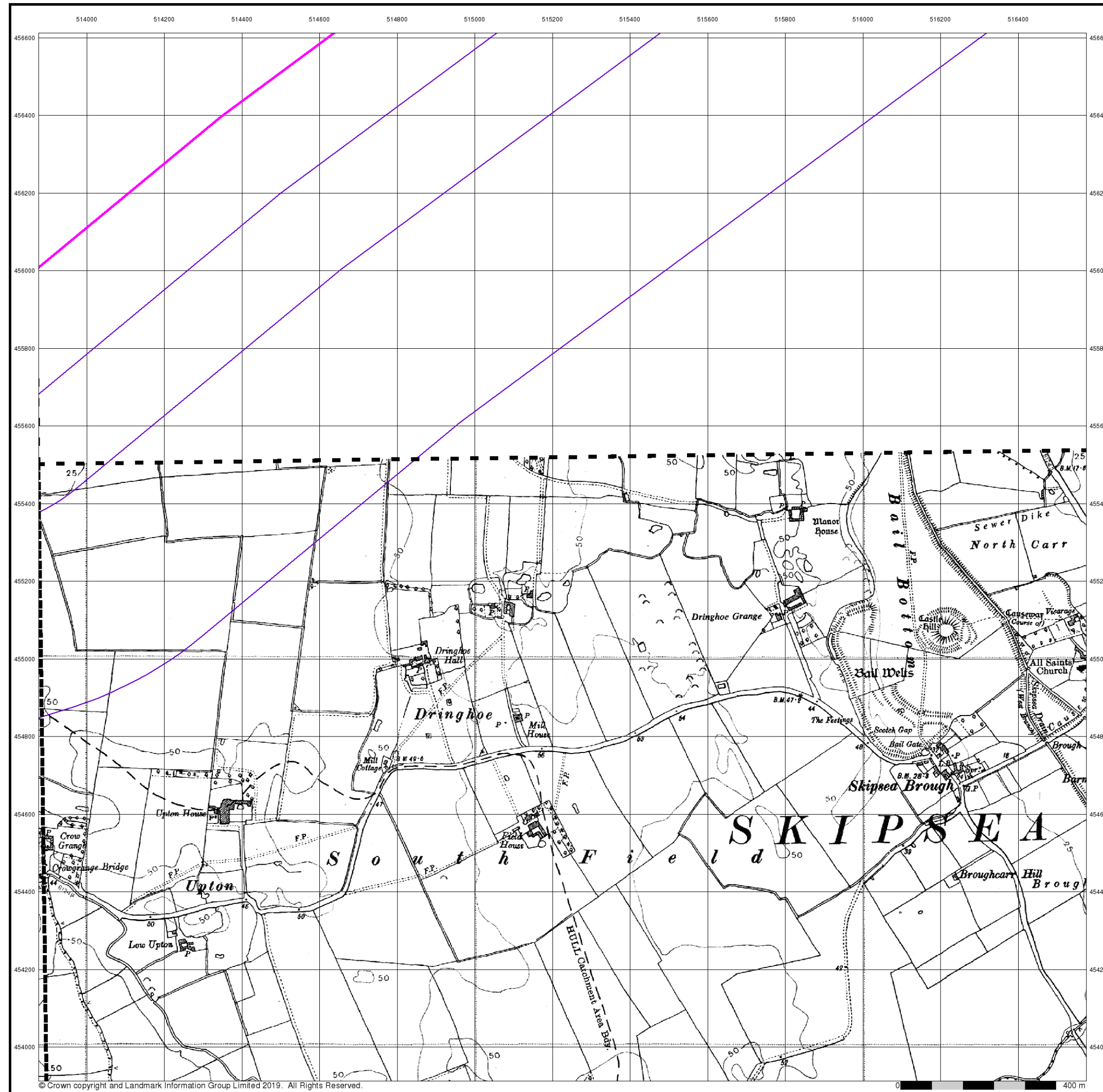

© Crown copyright and Landmark Information Group Limited 2019. All Rights Reserved.

Envirocheck®

LANDMARK INFORMATION GROUP®

Yorkshire

Published 1951

Source map scale - 1:10,560

The historical maps shown were reproduced from maps predominantly held at the scale adopted for England, Wales and Scotland in the 1840's. In 1854 the 1:2,500 scale was adopted for mapping urban areas; these maps were used to update the 1:10,560 maps. The published date given therefore is often some years later than the surveyed date. Before 1938, all OS maps were based on the Cassini Projection, with independent surveys of a single county or group of counties, giving rise to significant inaccuracies in outlying areas. In the late 1940's, a Provisional Edition was produced, which updated the 1:10,560 mapping from a number of sources. The maps appear unfinished - with all military camps and other strategic sites removed. These maps were initially overprinted with the National Grid. In 1970, the first 1:10,000 maps were produced using the Transverse Mercator Projection. The revision process continued until recently, with new editions appearing every 10 years or so for urban areas.

Map Name(s) and Date(s)

162SE 1951 1:10,560	180NW 1951 1:10,560
179NE 1951 1:10,560	

Historical Map - Slice C

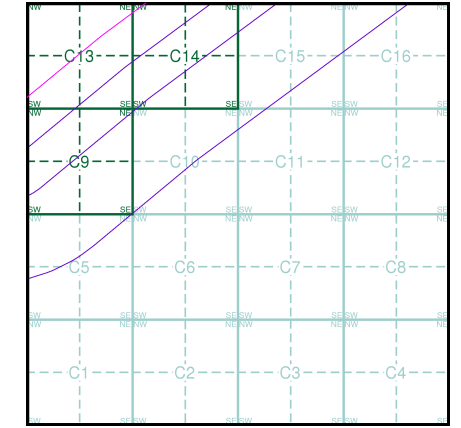

Order Details

Order Number: 201127462_1_1
 Customer Ref: PB8783-103-105
 National Grid Reference: 514690, 456000
 Slice: C
 Site Area (Ha): 2345.09
 Search Buffer (m): 1000

Site Details

Hornsea Route

Landmark
 INFORMATION GROUP

Tel: 0844 844 9952
 Fax: 0844 844 9951
 Web: www.envirocheck.co.uk

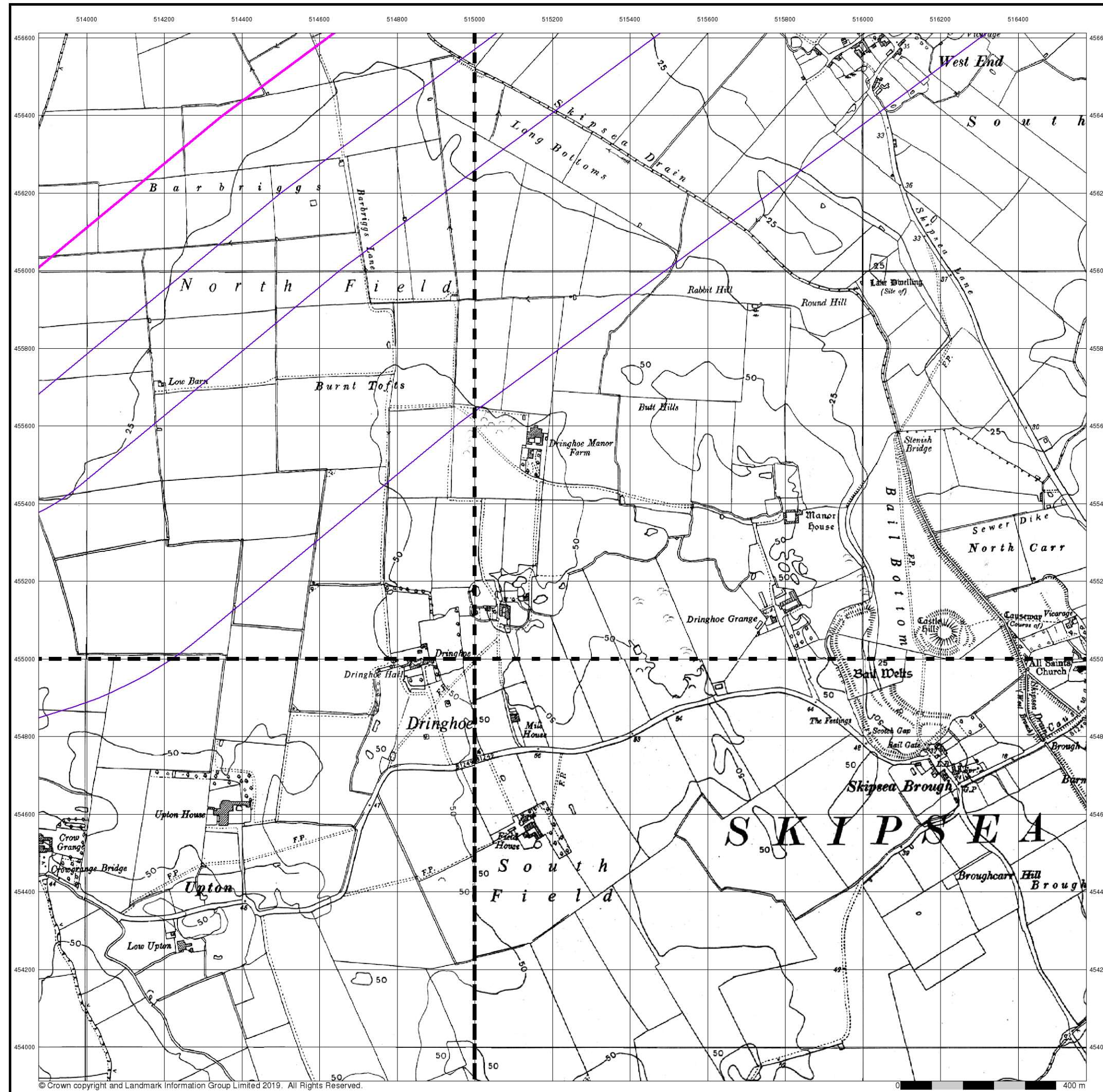

© Crown copyright and Landmark Information Group Limited 2019. All Rights Reserved.

Envirocheck®

LANDMARK INFORMATION GROUP®

Ordnance Survey Plan

Published 1956

Source map scale - 1:10,000

The historical maps shown were reproduced from maps predominantly held at the scale adopted for England, Wales and Scotland in the 1840's. In 1854 the 1:2,500 scale was adopted for mapping urban areas; these maps were used to update the 1:10,560 maps. The published date given therefore is often some years later than the surveyed date. Before 1938, all OS maps were based on the Cassini Projection, with independent surveys of a single county or group of counties, giving rise to significant inaccuracies in outlying areas. In the late 1940's, a Provisional Edition was produced, which updated the 1:10,560 mapping from a number of sources. The maps appear unfinished - with all military camps and other strategic sites removed. These maps were initially overprinted with the National Grid. In 1970, the first 1:10,000 maps were produced using the Transverse Mercator Projection. The revision process continued until recently, with new editions appearing every 10 years or so for urban areas.

Map Name(s) and Date(s)

TA15NW	TA15NE
1956	1956
1:10,560	1:10,560
TA15SW	TA15SE
1956	1956
1:10,560	1:10,560

Historical Map - Slice C

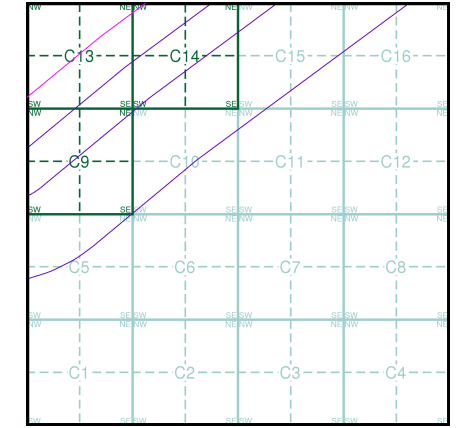

Order Details

Order Number: 201127462_1_1
 Customer Ref: PB8783-103-105
 National Grid Reference: 514690, 456000
 Slice: C
 Site Area (Ha): 2345.09
 Search Buffer (m): 1000

Site Details

Hornsea Route

Landmark®
 INFORMATION GROUP

Tel: 0844 844 9952
 Fax: 0844 844 9951
 Web: www.envirocheck.co.uk

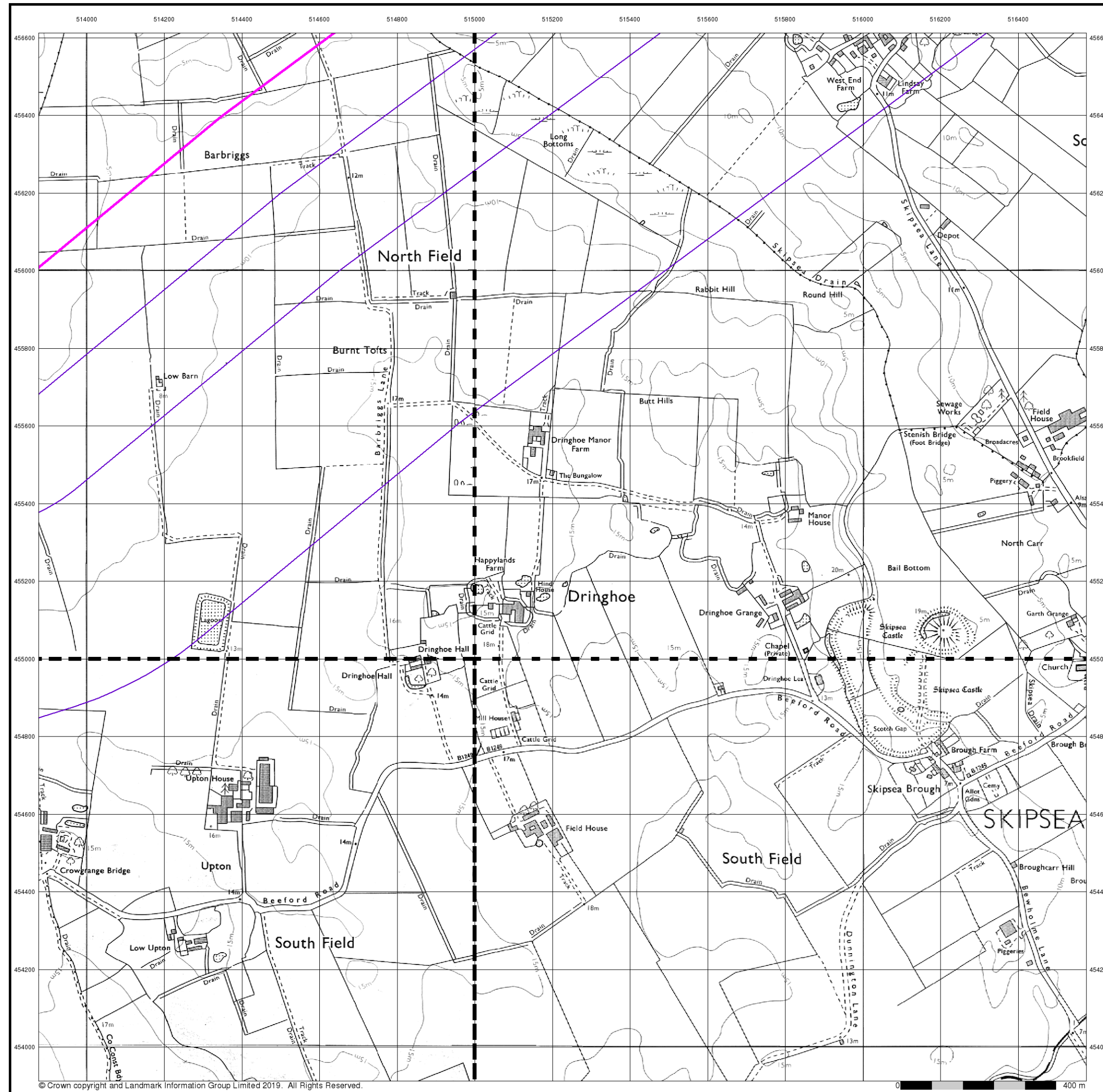

Ordnance Survey Plan

Published 1983

Source map scale - 1:10,000

The historical maps shown were reproduced from maps predominantly held at the scale adopted for England, Wales and Scotland in the 1840's. In 1854 the 1:2,500 scale was adopted for mapping urban areas; these maps were used to update the 1:10,560 maps. The published date given therefore is often some years later than the surveyed date. Before 1938, all OS maps were based on the Cassini Projection, with independent surveys of a single county or group of counties, giving rise to significant inaccuracies in outlying areas. In the late 1940's, a Provisional Edition was produced, which updated the 1:10,560 mapping from a number of sources. The maps appear unfinished - with all military camps and other strategic sites removed. These maps were initially overprinted with the National Grid. In 1970, the first 1:10,000 maps were produced using the Transverse Mercator Projection. The revision process continued until recently, with new editions appearing every 10 years or so for urban areas.

Map Name(s) and Date(s)

TA15NW 1983 1:10,000	TA15NE 1983 1:10,000
TA15SW 1983 1:10,000	TA15SE 1983 1:10,000

Historical Map - Slice C

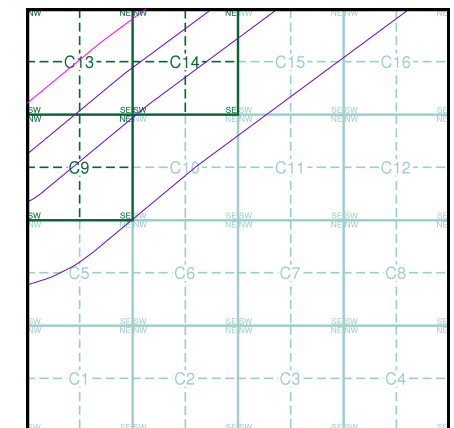

Order Details

Order Number: 201127462_1_1
 Customer Ref: PB8783-103-105
 National Grid Reference: 514690, 456000
 Slice: C
 Site Area (Ha): 2345.09
 Search Buffer (m): 1000

Site Details

Hornsea Route

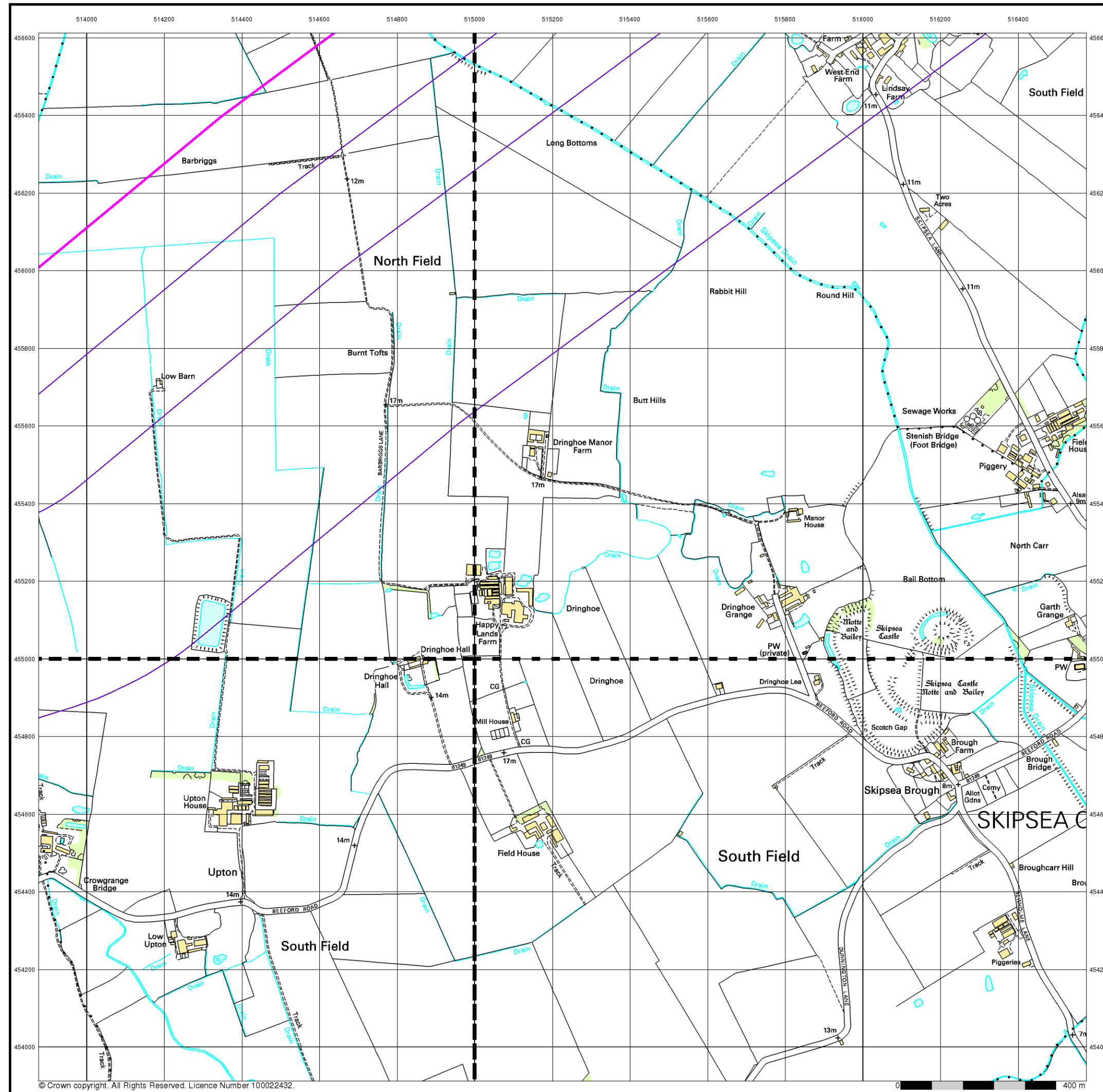

10k Raster Mapping
Published 1999
Source map scale - 1:10,000

The historical maps shown were produced from the Ordnance Survey's 1:10,000 colour raster mapping. These maps are derived from Landplan which replaced the old 1:10,000 maps originally published in 1970. The data is highly detailed showing buildings, fences and field boundaries as well as all roads, tracks and paths. Road names are also included together with the relevant road number and classification. Boundary information depiction includes county, unitary authority, district, civil parish and constituency.

Map Name(s) and Date(s)

TA15NW	TA15NE
1999	1999
1:10,000	1:10,000
TA15SW	TA15SE
1999	1999
1:10,000	1:10,000

Historical Map - Slice C

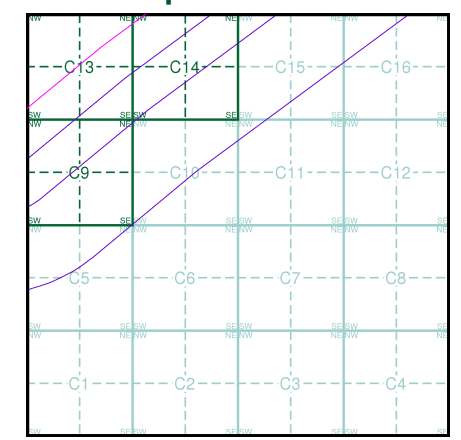

Order Details

Order Number: 201127462_1_1
 Customer Ref: PB8783-103-105
 National Grid Reference: 514690, 456000
 Slice: C
 Site Area (Ha): 2345.09
 Search Buffer (m): 1000

Site Details

Hornsea Route

Street View

Published 2019

Source map scale - 1:10,000

Street View is a street-level map for the whole of Great Britain produced by the Ordnance Survey. These maps are provided at a nominal scale of 1:10,000

Map Name(s) and Date(s)



Street View Map - Slice C

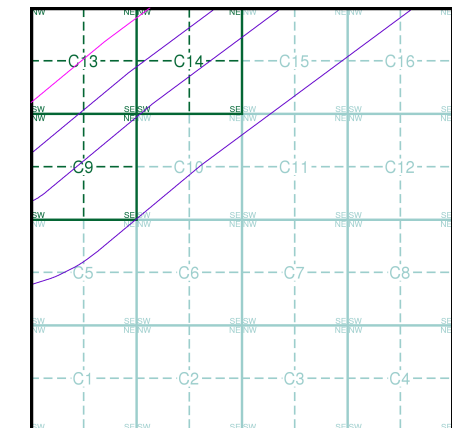

Order Details

Order Number: 201127462_1_1
Customer Ref: PB8783-103-105
National Grid Reference: 514690, 456000
Slice: C
Site Area (Ha): 2345.09
Search Buffer (m): 1000

Site Details

Hornsea Route

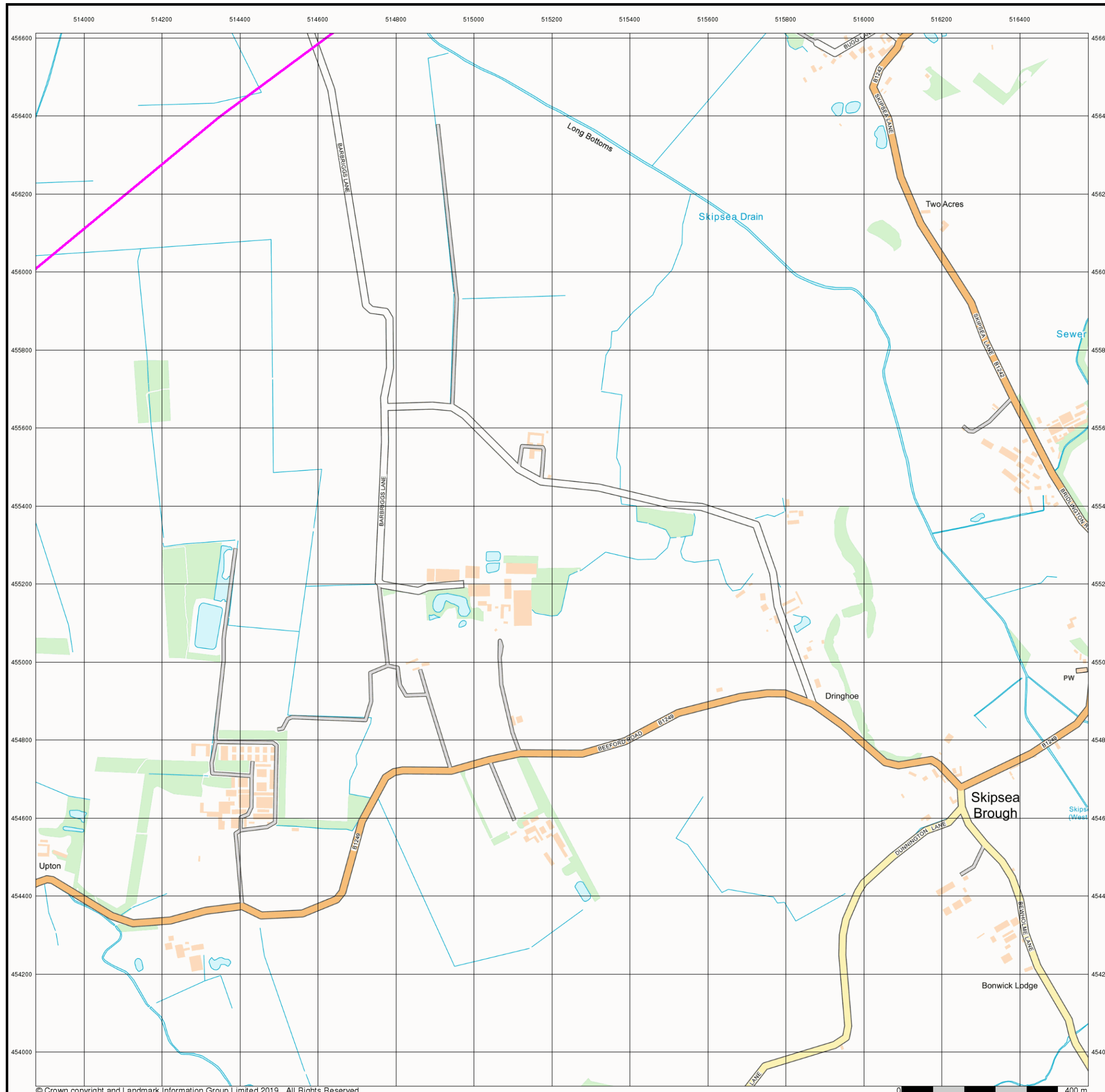

Historical Mapping Legends

Ordnance Survey County Series 1:10,560

- Gravel Pit
- Sand Pit
- Other Pits
- Quarry
- Shingle
- Orchard
- Osiers
- Reeds
- Marsh
- Mixed Wood
- Deciduous
- Brushwood
- Fir
- Furze
- Rough Pasture
- Arrow denotes flow of water
- Trigonometrical Station
- Site of Antiquities
- Bench Mark
- Pump, Guide Post, Signal Post
- Well, Spring, Boundary Post
- 285** Surface Level
- Sketched Contour
- Instrumental Contour
- Main Roads
- Minor Roads
- Sunken Road
- Raised Road
- Road over Railway
- Railway over River
- Railway over Road
- Level Crossing
- Road over River or Canal
- Road over Stream
- Road over Stream
- County Boundary (Geographical)
- County & Civil Parish Boundary
- Administrative County & Civil Parish Boundary
- County Borough Boundary (England)
- County Burgh Boundary (Scotland)
- Rural District Boundary
- Civil Parish Boundary

Ordnance Survey Plan 1:10,000

- Chalk Pit, Clay Pit or Quarry
- Gravel Pit
- Sand Pit
- Disused Pit or Quarry
- Refuse or Slag Heap
- Lake, Loch or Pond
- Dunes
- Boulders
- Coniferous Trees
- Non-Coniferous Trees
- Orchard
- Scrub
- Coppice
- Bracken
- Heath
- Rough Grassland
- Marsh
- Reeds
- Saltings
- Building
- Glasshouse
- Sloping Masonry
- Pylon
- Electricity Transmission Line
- Pole
- Cutting
- Embankment
- Road Under
- Road Over
- Level Crossing
- Foot Bridge
- Standard Gauge Multiple Track
- Standard Gauge Single Track
- Siding, Tramway or Mineral Line
- Narrow Gauge
- Geographical County
- Administrative County, County Borough or County of City
- Municipal Borough, Urban or Rural District, Burgh or District Council
- Borough, Burgh or County Constituency
- Civil Parish
- BP, BS Boundary Post or Stone
- Ch Church
- CH Club House
- F E Sta Fire Engine Station
- FB Foot Bridge
- Fn Fountain
- GP Guide Post
- MP Mile Post
- MS Mile Stone
- Pol Sta Police Station
- PO Post Office
- PC Public Convenience
- PH Public House
- SB Signal Box
- Spr Spring
- TCB Telephone Call Box
- TCP Telephone Call Post
- W Well

1:10,000 Raster Mapping

- Gravel Pit
- Refuse tip or slag heap
- Rock
- Rock (scattered)
- Boulders
- Boulders (scattered)
- Shingle
- Mud
- Mud
- Sand Pit
- Sand
- Sand Pit
- Slopes
- Top of cliff
- General detail
- Underground detail
- Overhead detail
- Narrow gauge railway
- Multi-track railway
- Single track railway
- County boundary (England only)
- Civil, parish or community boundary
- District, Unitary, Metropolitan, London Borough boundary
- Constituency boundary
- Area of wooded vegetation
- Non-coniferous trees
- Non-coniferous trees (scattered)
- Coniferous trees
- Coniferous trees (scattered)
- Positioned tree
- Orchard
- Coppice or Osiers
- Rough Grassland
- Heath
- Scrub
- Marsh, Salt Marsh or Reeds
- Water feature
- Flow arrows
- MHW(S) Mean high water (springs)
- MLW(S) Mean low water (springs)
- Telephone line (where shown)
- Electricity transmission line (with poles)
- Bench mark (where shown)
- Triangulation station
- Point feature (e.g. Guide Post or Mile Stone)
- Pylon, flare stack or lighting tower
- Site of (antiquity)
- Glasshouse
- General Building
- Important Building

Historical Mapping & Photography included:

Mapping Type	Scale	Date	Pg
Yorkshire	1:10,560	1854	2
Yorkshire	1:10,560	1892	3
Yorkshire	1:10,560	1911	4
Yorkshire	1:10,560	1951	5
Ordnance Survey Plan	1:10,000	1956	6
Ordnance Survey Plan	1:10,000	1982	7
10K Raster Mapping	1:10,000	1999	8
Street View	Variable		9

Historical Map - Slice C

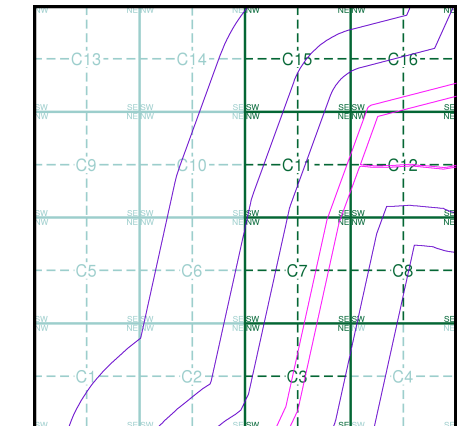

Order Details

Order Number: 201127465_1_1
 Customer Ref: PB8783-103-105
 National Grid Reference: 506560, 453280
 Slice: C
 Site Area (Ha): 72.
 Search Buffer (m): 1000

Site Details

Hornsea Route

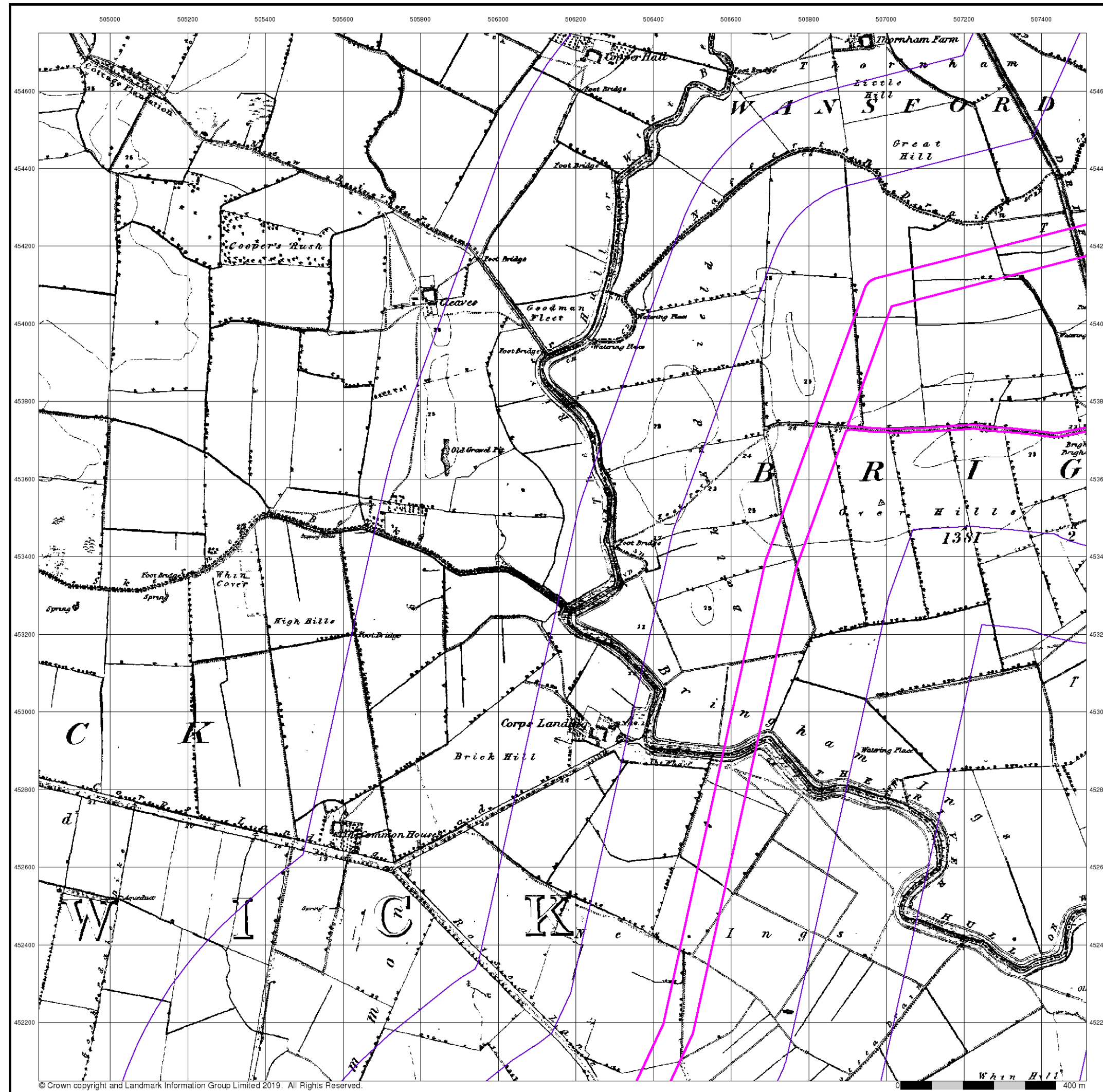

Envirocheck®

LANDMARK INFORMATION GROUP®

Yorkshire

Published 1854

Source map scale - 1:10,560

The historical maps shown were reproduced from maps predominantly held at the scale adopted for England, Wales and Scotland in the 1840's. In 1854 the 1:2,500 scale was adopted for mapping urban areas; these maps were used to update the 1:10,560 maps. The published date given therefore is often some years later than the surveyed date. Before 1938, all OS maps were based on the Cassini Projection, with independent surveys of a single county or group of counties, giving rise to significant inaccuracies in outlying areas. In the late 1940's, a Provisional Edition was produced, which updated the 1:10,560 mapping from a number of sources. The maps appear unfinished - with all military camps and other strategic sites removed. These maps were initially overprinted with the National Grid. In 1970, the first 1:10,000 maps were produced using the Transverse Mercator Projection. The revision process continued until recently, with new editions appearing every 10 years or so for urban areas.

Map Name(s) and Date(s)

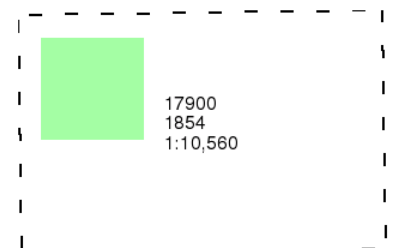

Historical Map - Slice C

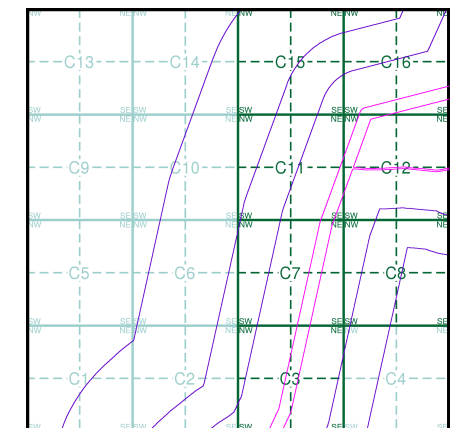

Order Details

Order Number: 201127465_1_1
 Customer Ref: PB8783-103-105
 National Grid Reference: 506560, 453280
 Slice: C
 Site Area (Ha): 72
 Search Buffer (m): 1000

Site Details

Hornsea Route

Landmark®
 INFORMATION GROUP

Tel: 0844 844 9952
 Fax: 0844 844 9951
 Web: www.envirocheck.co.uk

The historical maps shown were reproduced from maps predominantly held at the scale adopted for England, Wales and Scotland in the 1840's. In 1854 the 1:2,500 scale was adopted for mapping urban areas; these maps were used to update the 1:10,560 maps. The published date given therefore is often some years later than the surveyed date. Before 1938, all OS maps were based on the Cassini Projection, with independent surveys of a single county or group of counties, giving rise to significant inaccuracies in outlying areas. In the late 1940's, a Provisional Edition was produced, which updated the 1:10,560 mapping from a number of sources. The maps appear unfinished - with all military camps and other strategic sites removed. These maps were initially overprinted with the National Grid. In 1970, the first 1:10,000 maps were produced using the Transverse Mercator Projection. The revision process continued until recently, with new editions appearing every 10 years or so for urban areas.

Map Name(s) and Date(s)

179NW	1892	1:10,560
179SW	1892	1:10,560

Historical Map - Slice C

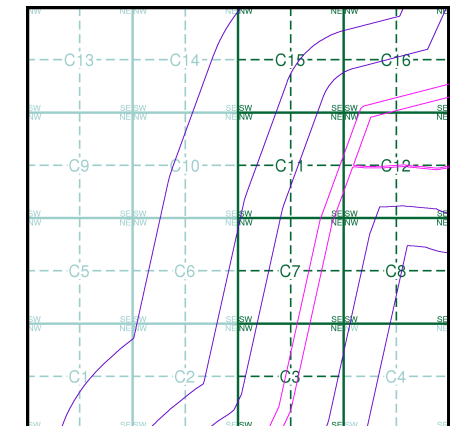

Order Details

Order Number: 201127465_1_1
 Customer Ref: PB8783-103-105
 National Grid Reference: 506560, 453280
 Slice: C
 Site Area (Ha): 72
 Search Buffer (m): 1000

Site Details

Hornsea Route

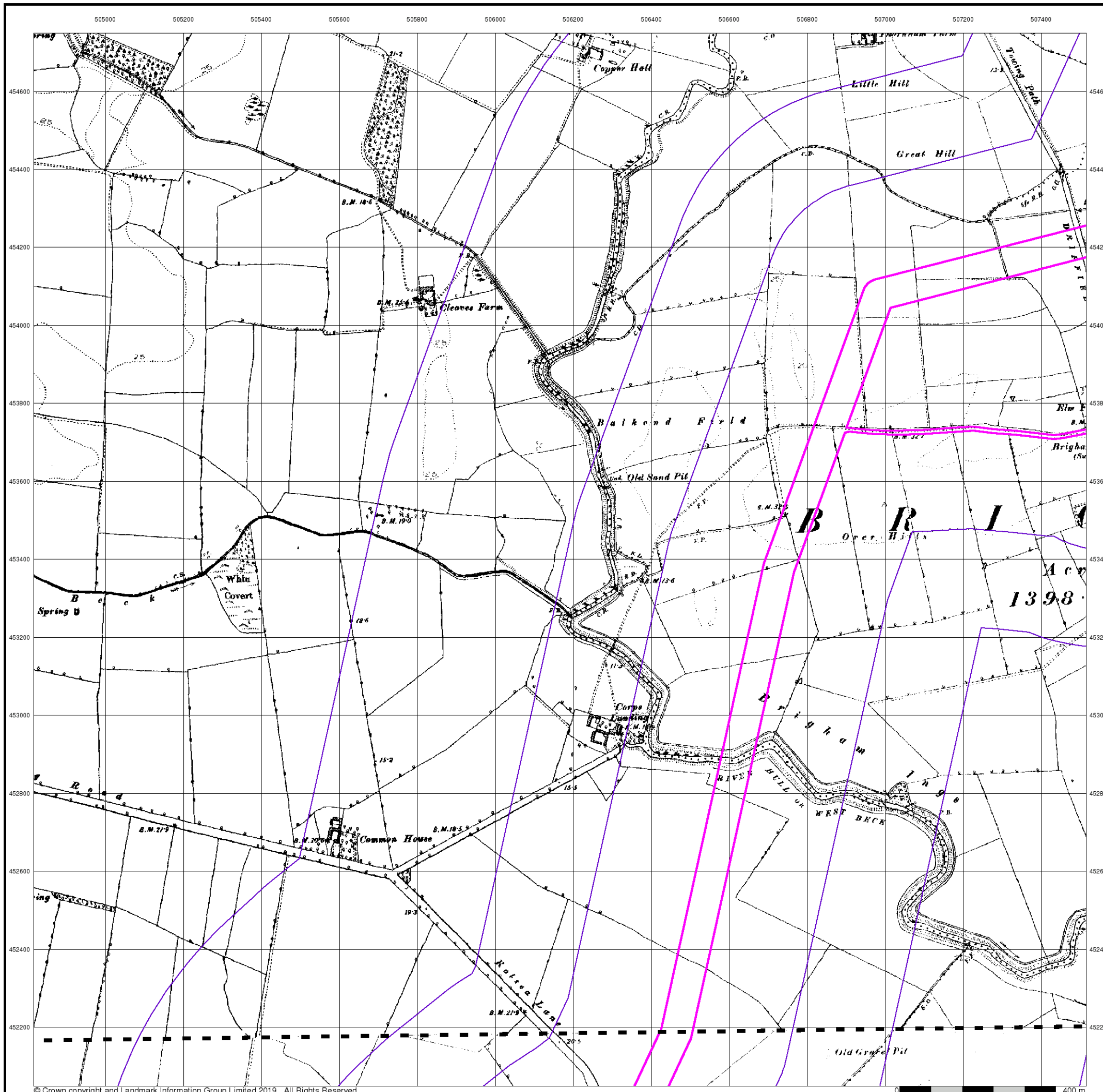

The historical maps shown were reproduced from maps predominantly held at the scale adopted for England, Wales and Scotland in the 1840's. In 1854 the 1:2,500 scale was adopted for mapping urban areas; these maps were used to update the 1:10,560 maps. The published date given therefore is often some years later than the surveyed date. Before 1938, all OS maps were based on the Cassini Projection, with independent surveys of a single county or group of counties, giving rise to significant inaccuracies in outlying areas. In the late 1940's, a Provisional Edition was produced, which updated the 1:10,560 mapping from a number of sources. The maps appear unfinished - with all military camps and other strategic sites removed. These maps were initially overprinted with the National Grid. In 1970, the first 1:10,000 maps were produced using the Transverse Mercator Projection. The revision process continued until recently, with new editions appearing every 10 years or so for urban areas.

Map Name(s) and Date(s)

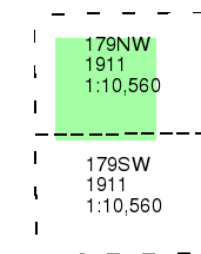

Historical Map - Slice C

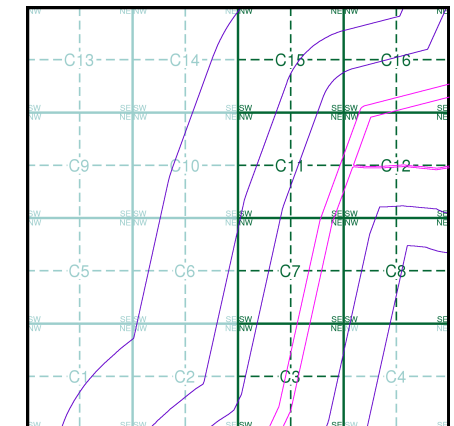

Order Details

Order Number: 201127465_1_1
 Customer Ref: PB8783-103-105
 National Grid Reference: 506560, 453280
 Slice: C
 Site Area (Ha): 72
 Search Buffer (m): 1000

Site Details

Hornsea Route

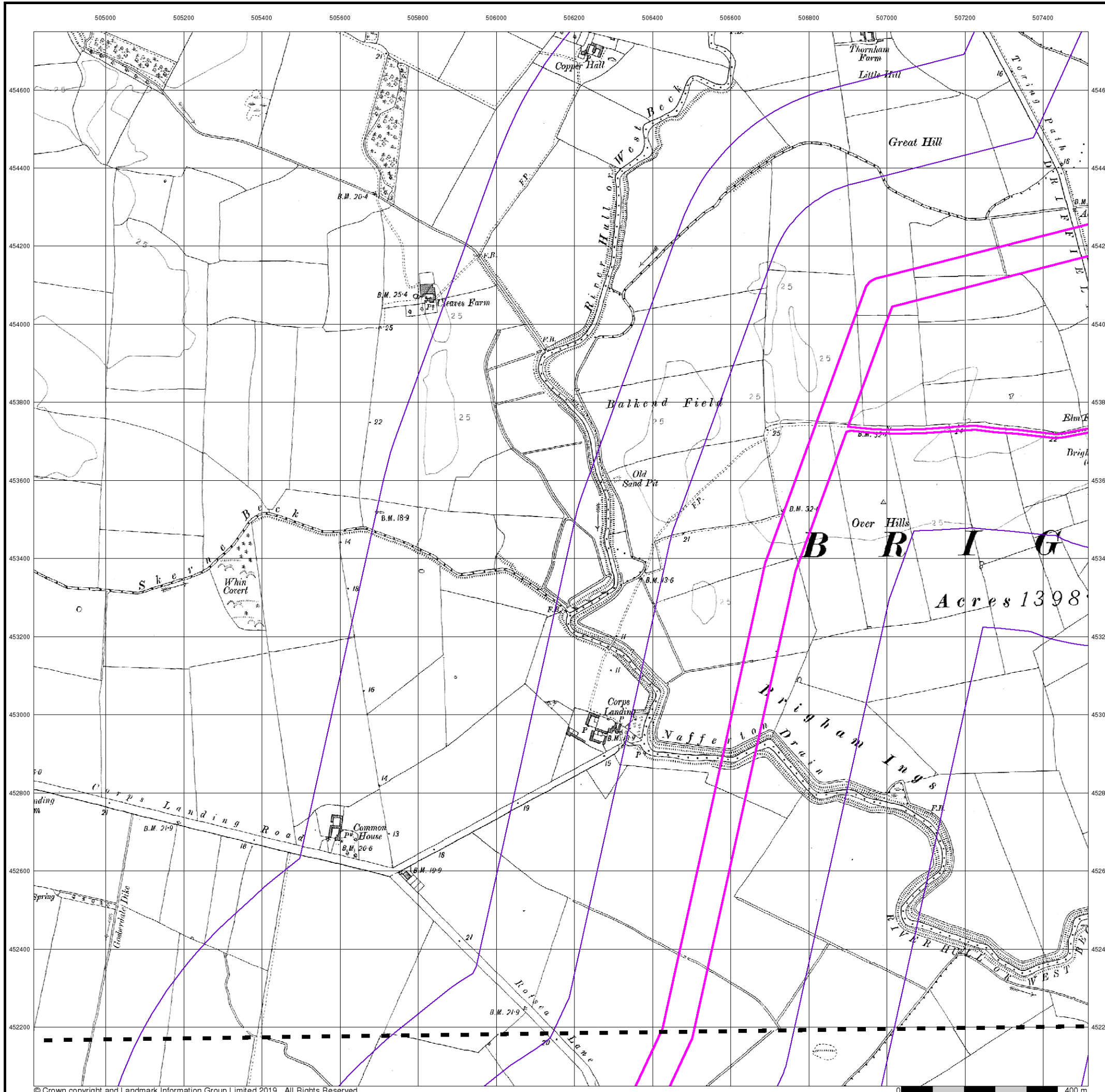

The historical maps shown were reproduced from maps predominantly held at the scale adopted for England, Wales and Scotland in the 1840's. In 1854 the 1:2,500 scale was adopted for mapping urban areas; these maps were used to update the 1:10,560 maps. The published date given therefore is often some years later than the surveyed date. Before 1938, all OS maps were based on the Cassini Projection, with independent surveys of a single county or group of counties, giving rise to significant inaccuracies in outlying areas. In the late 1940's, a Provisional Edition was produced, which updated the 1:10,560 mapping from a number of sources. The maps appear unfinished - with all military camps and other strategic sites removed. These maps were initially overprinted with the National Grid. In 1970, the first 1:10,000 maps were produced using the Transverse Mercator Projection. The revision process continued until recently, with new editions appearing every 10 years or so for urban areas.

Map Name(s) and Date(s)

179NW	1951	1:10,560
179SW	1951	1:10,560

Historical Map - Slice C

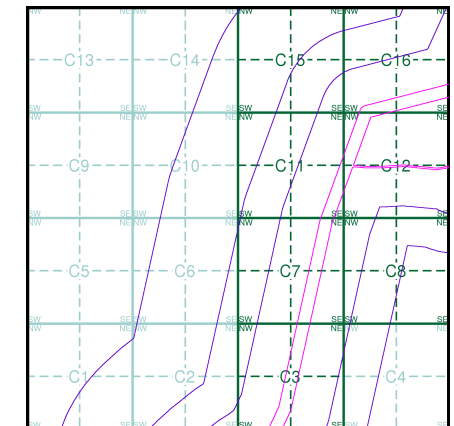

Order Details

Order Number: 201127465_1_1
 Customer Ref: PB8783-103-105
 National Grid Reference: 506560, 453280
 Slice: C
 Site Area (Ha): 72
 Search Buffer (m): 1000

Site Details

Hornsea Route

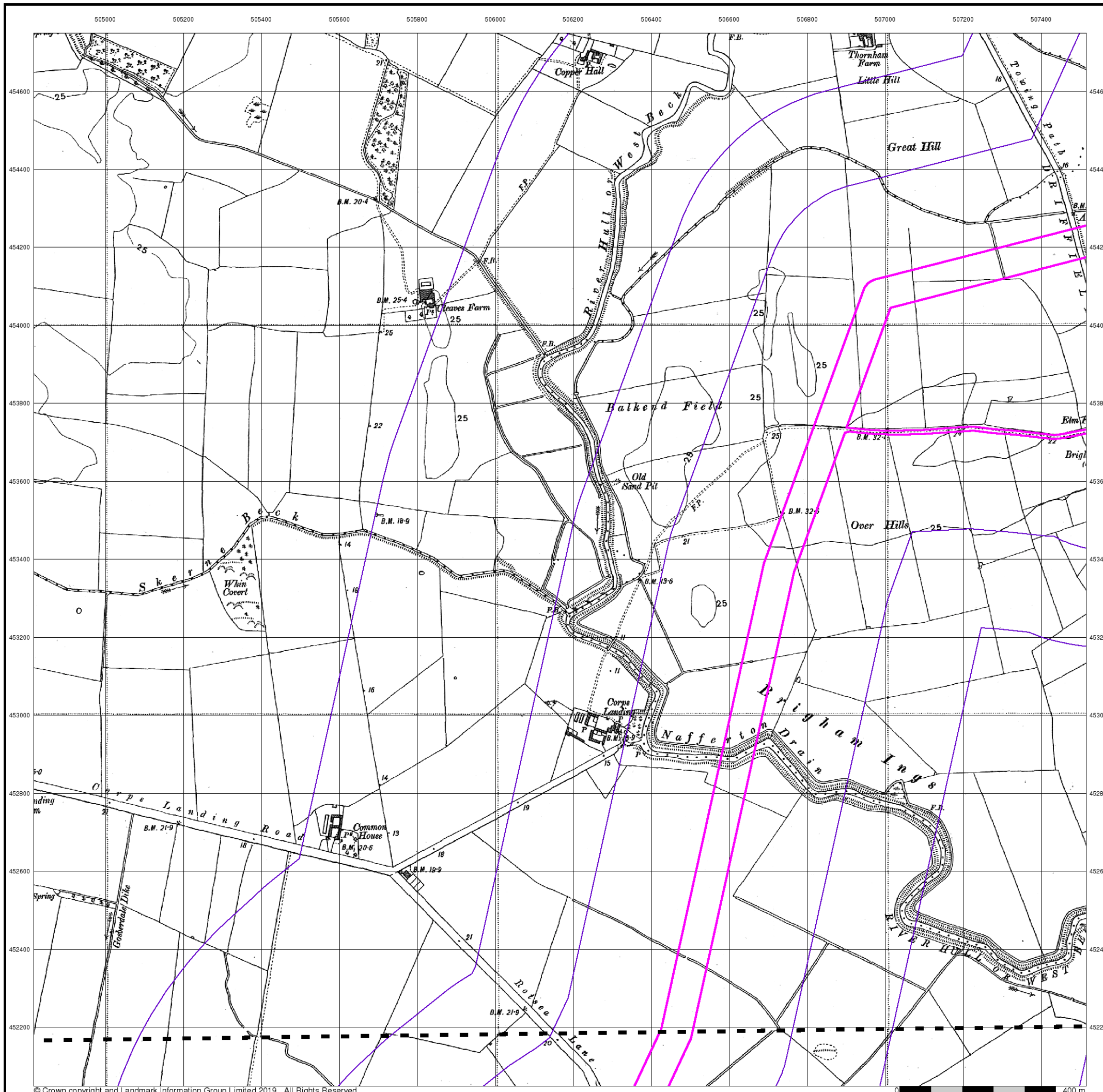

Ordnance Survey Plan

Published 1956

Source map scale - 1:10,000

The historical maps shown were reproduced from maps predominantly held at the scale adopted for England, Wales and Scotland in the 1840's. In 1854 the 1:2,500 scale was adopted for mapping urban areas; these maps were used to update the 1:10,560 maps. The published date given therefore is often some years later than the surveyed date. Before 1938, all OS maps were based on the Cassini Projection, with independent surveys of a single county or group of counties, giving rise to significant inaccuracies in outlying areas. In the late 1940's, a Provisional Edition was produced, which updated the 1:10,560 mapping from a number of sources. The maps appear unfinished - with all military camps and other strategic sites removed. These maps were initially overprinted with the National Grid. In 1970, the first 1:10,000 maps were produced using the Transverse Mercator Projection. The revision process continued until recently, with new editions appearing every 10 years or so for urban areas.

Map Name(s) and Date(s)

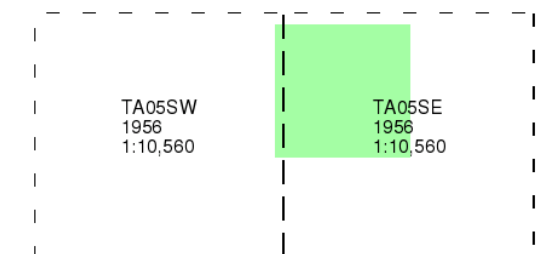

Historical Map - Slice C

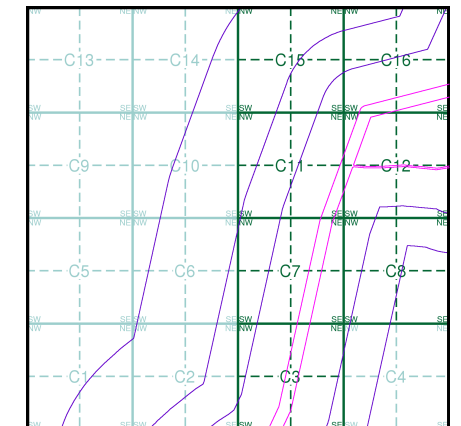

Order Details

Order Number: 201127465_1_1
 Customer Ref: PB8783-103-105
 National Grid Reference: 506560, 453280
 Slice: C
 Site Area (Ha): 72.
 Search Buffer (m): 1000

Site Details

Hornsea Route

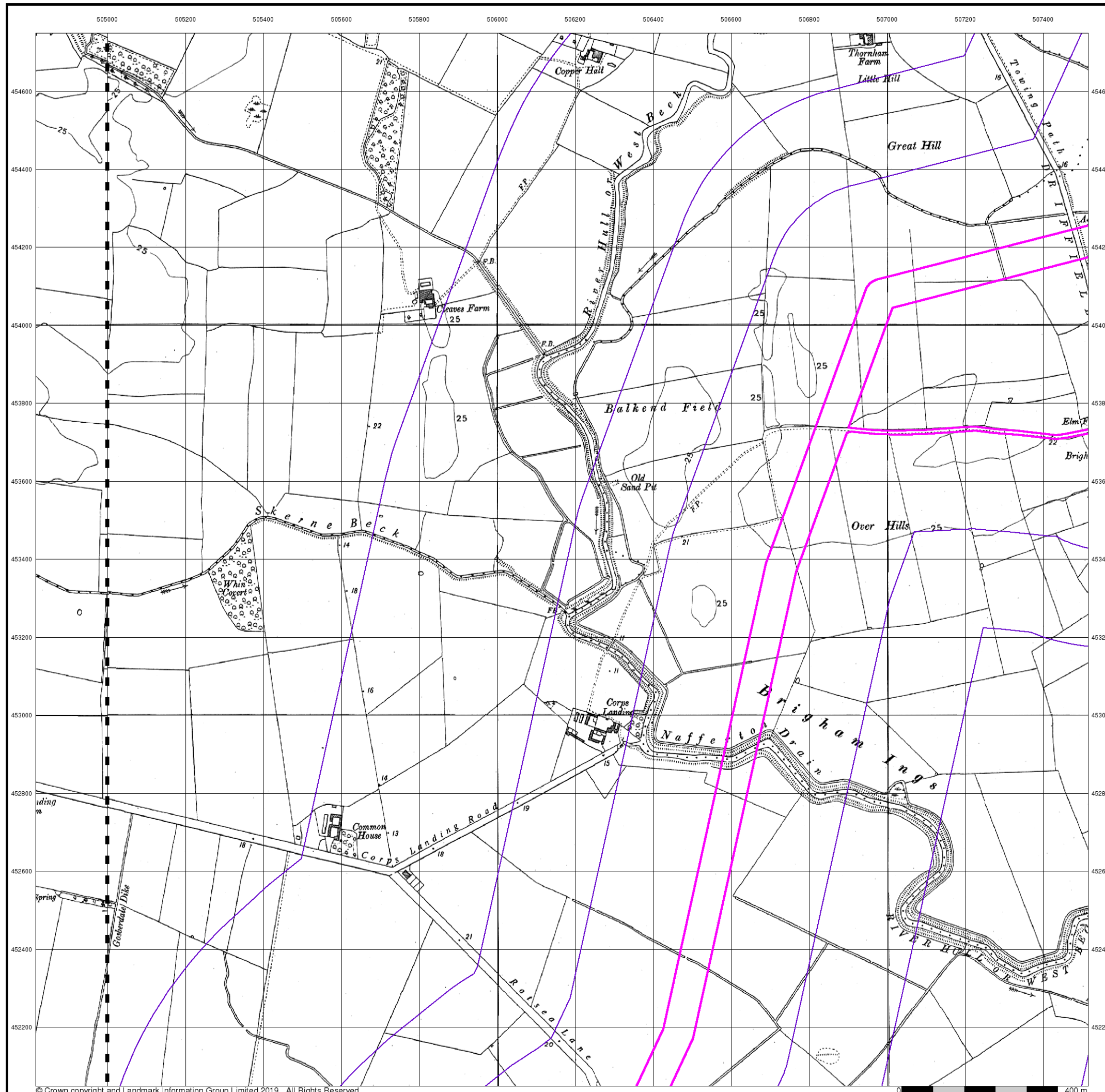

Ordnance Survey Plan

Published 1982

Source map scale - 1:10,000

The historical maps shown were reproduced from maps predominantly held at the scale adopted for England, Wales and Scotland in the 1840's. In 1854 the 1:2,500 scale was adopted for mapping urban areas; these maps were used to update the 1:10,560 maps. The published date given therefore is often some years later than the surveyed date. Before 1938, all OS maps were based on the Cassini Projection, with independent surveys of a single county or group of counties, giving rise to significant inaccuracies in outlying areas. In the late 1940's, a Provisional Edition was produced, which updated the 1:10,560 mapping from a number of sources. The maps appear unfinished - with all military camps and other strategic sites removed. These maps were initially overprinted with the National Grid. In 1970, the first 1:10,000 maps were produced using the Transverse Mercator Projection. The revision process continued until recently, with new editions appearing every 10 years or so for urban areas.

Map Name(s) and Date(s)

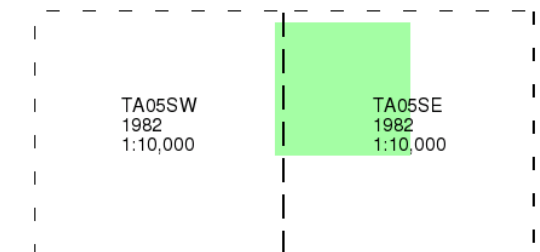

Historical Map - Slice C

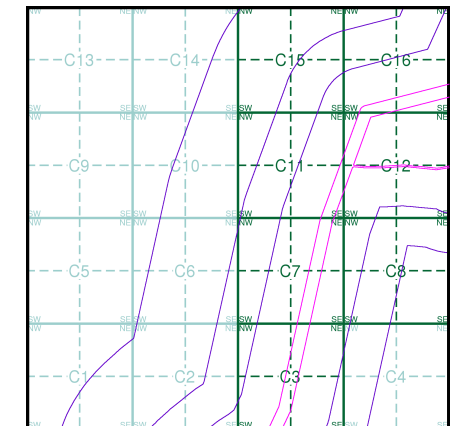

Order Details

Order Number: 201127465_1_1
 Customer Ref: PB8783-103-105
 National Grid Reference: 506560, 453280
 Slice: C
 Site Area (Ha): 72.
 Search Buffer (m): 1000

Site Details

Hornsea Route

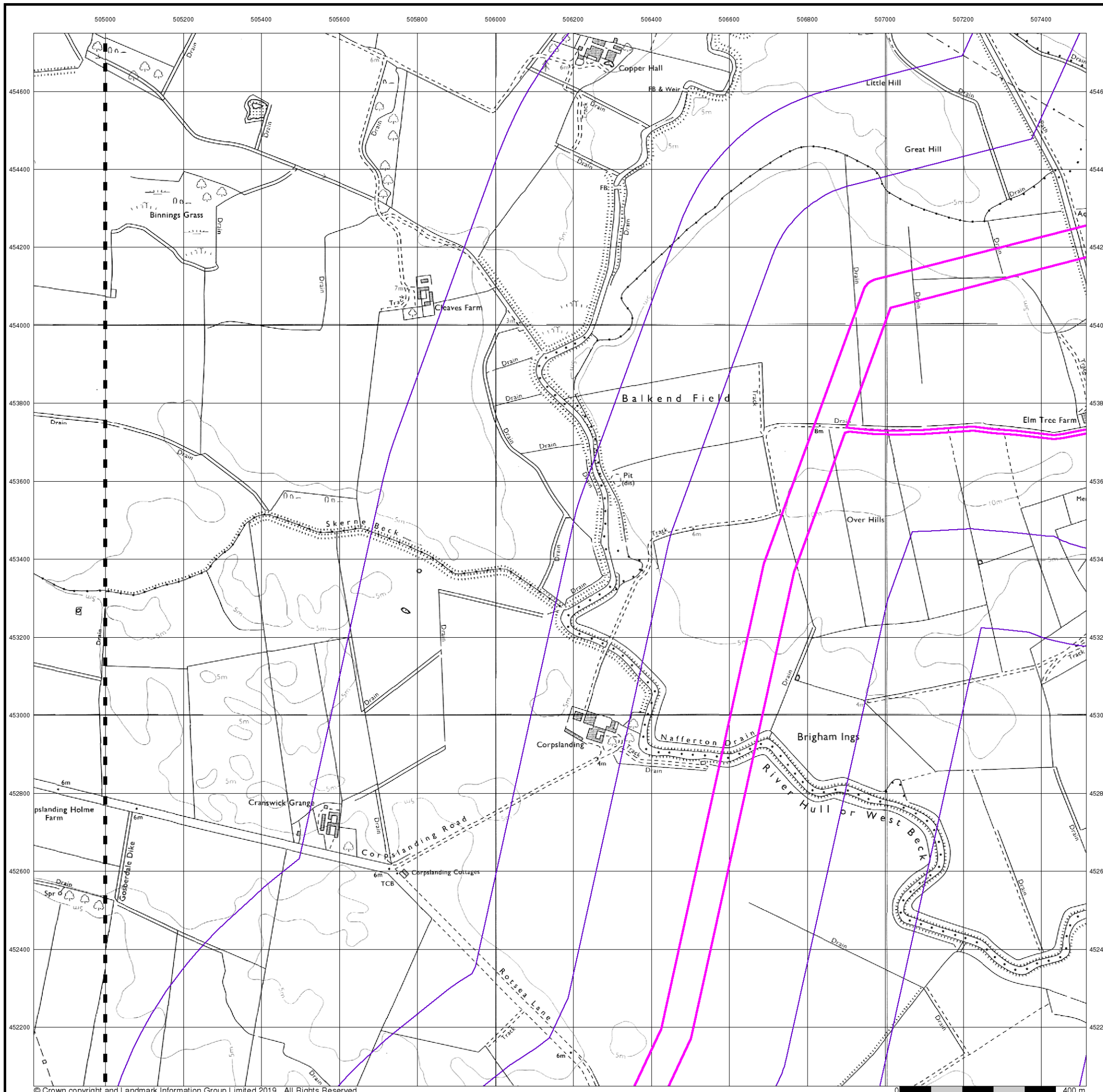

10k Raster Mapping

Published 1999

Source map scale - 1:10,000

The historical maps shown were produced from the Ordnance Survey's 1:10,000 colour raster mapping. These maps are derived from Landplan which replaced the old 1:10,000 maps originally published in 1970. The data is highly detailed showing buildings, fences and field boundaries as well as all roads, tracks and paths. Road names are also included together with the relevant road number and classification. Boundary information depiction includes county, unitary authority, district, civil parish and constituency.

Map Name(s) and Date(s)

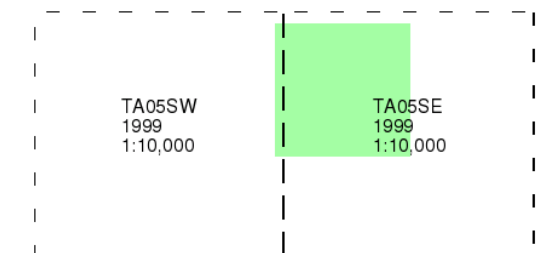

Historical Map - Slice C

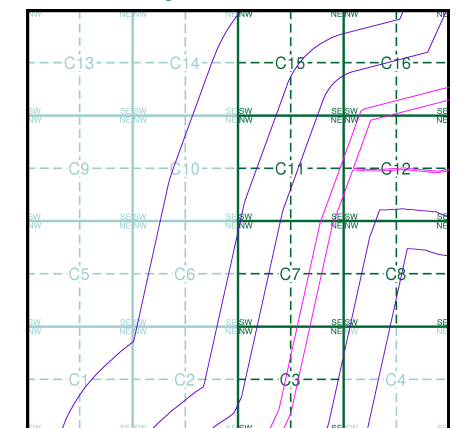

Order Details

Order Number: 201127465_1_1
 Customer Ref: PB8783-103-105
 National Grid Reference: 506560, 453280
 Slice: C
 Site Area (Ha): 72.
 Search Buffer (m): 1000

Site Details

Hornsea Route

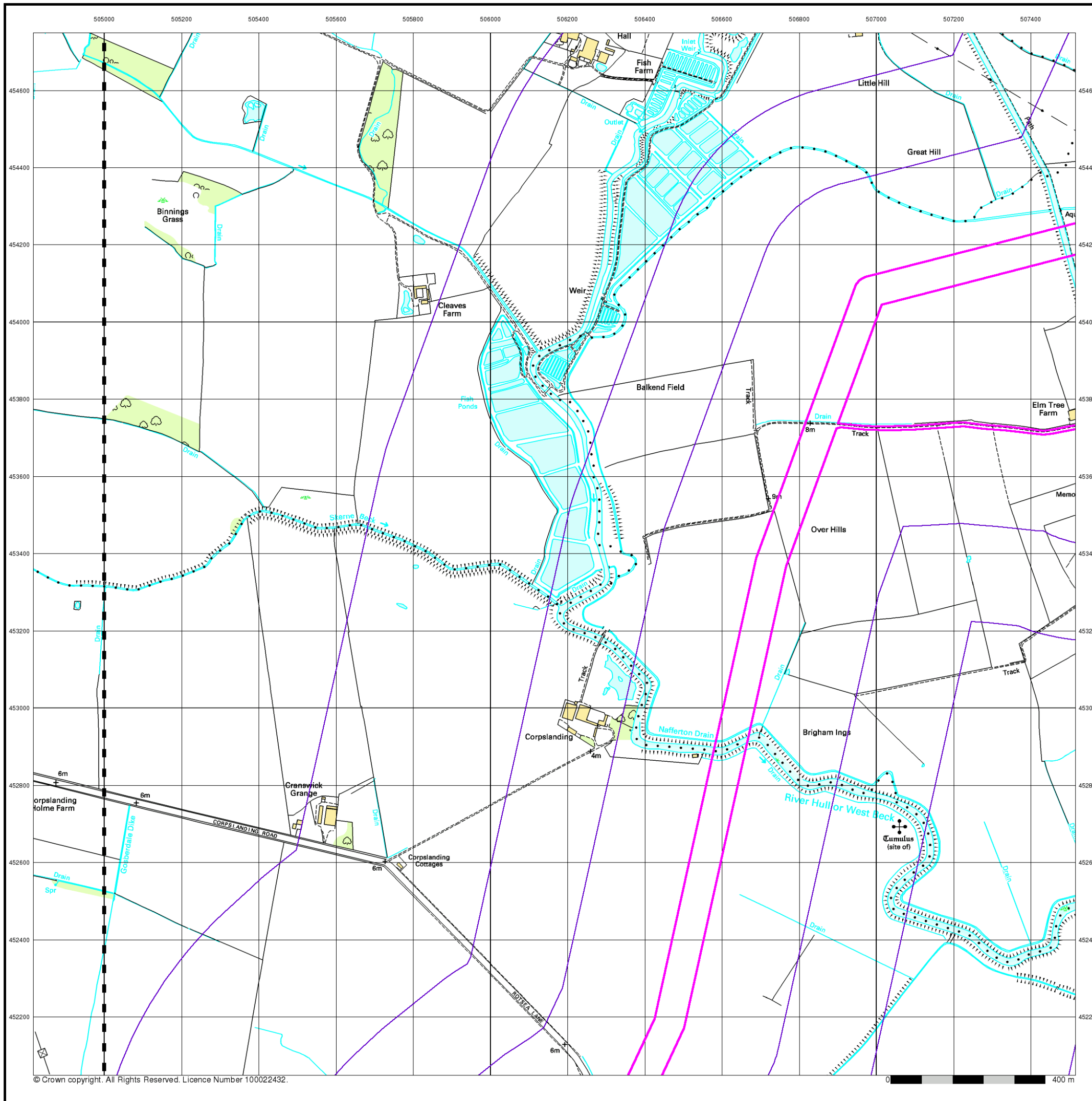

Street View

Published 2019

Source map scale - 1:10,000

Street View is a street-level map for the whole of Great Britain produced by the Ordnance Survey. These maps are provided at a nominal scale of 1:10,000

Map Name(s) and Date(s)



Street View Map - Slice C

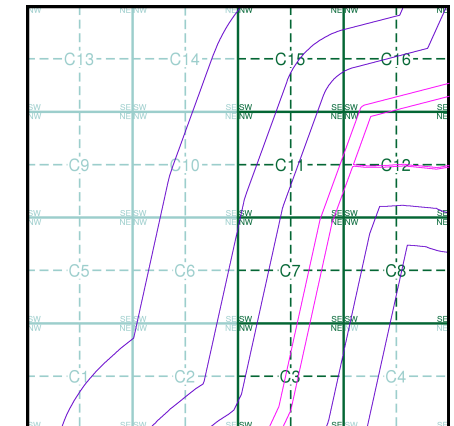

Order Details

Order Number: 201127465_1_1
Customer Ref: PB8783-103-105
National Grid Reference: 506560, 453280
Slice: C
Site Area (Ha): 72.
Search Buffer (m): 1000

Site Details

Hornsea Route

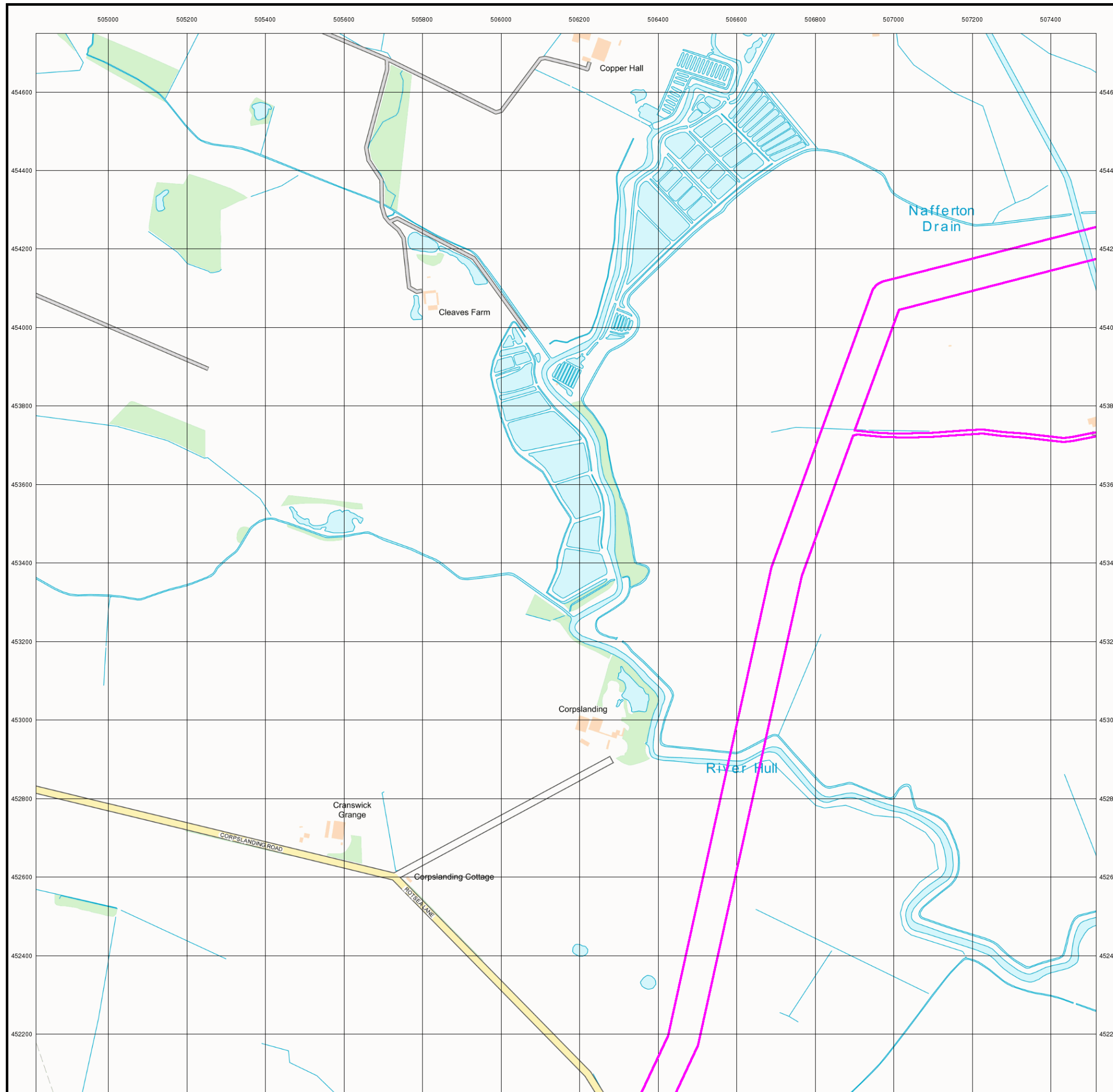

Historical Mapping Legends

Ordnance Survey County Series 1:10,560

	Gravel Pit		Sand Pit		Other Pits
	Quarry		Shingle		Orchard
	Osiers		Reeds		Marsh
	Mixed Wood		Deciduous		Brushwood
	Fir		Furze		Rough Pasture
	Arrow denotes flow of water		Trigonometrical Station		
	Site of Antiquities		Bench Mark		
	Pump, Guide Post, Signal Post		Well, Spring, Boundary Post		
	-285 Surface Level				
	Sketched Contour		Instrumental Contour		
	Main Roads		Minor Roads		
	Sunken Road		Raised Road		
	Road over Railway		Railway over River		
	Railway over Road		Level Crossing		
	Road over River or Canal		Road over Stream		
	Road over Stream				
	County Boundary (Geographical)				
	County & Civil Parish Boundary				
	Administrative County & Civil Parish Boundary				
	County Borough Boundary (England)				
	County Burgh Boundary (Scotland)				
	Rural District Boundary				
	Civil Parish Boundary				

Ordnance Survey Plan 1:10,000

	Chalk Pit, Clay Pit or Quarry		Gravel Pit
	Sand Pit		Disused Pit or Quarry
	Refuse or Slag Heap		Lake, Loch or Pond
	Dunes		Boulders
	Coniferous Trees		Non-Coniferous Trees
	Orchard		Scrub
	Coppice		Heath
	Rough Grassland		Marsh
	Reeds		Saltings
	Building		Glasshouse
	Sloping Masonry		Pylon
	Electricity Transmission Line		Pole
	Cutting		Embankment
	Standard Gauge Multiple Track		Standard Gauge Single Track
	Siding, Tramway or Mineral Line		Narrow Gauge
	Geographical County		
	Administrative County, County Borough or County of City		
	Municipal Borough, Urban or Rural District, Burgh or District Council		
	Borough, Burgh or County Constituency Shown only when not coincident with other boundaries		
	Civil Parish Shown alternately when coincidence of boundaries occurs		
	BP, BS Boundary Post or Stone		Pol Sta Police Station
	Ch Church		PO Post Office
	CH Club House		PC Public Convenience
	F E Sta Fire Engine Station		PH Public House
	FB Foot Bridge		SB Signal Box
	Fn Fountain		Spr Spring
	GP Guide Post		TCB Telephone Call Box
	MP Mile Post		TCP Telephone Call Post
	MS Mile Stone		W Well

1:10,000 Raster Mapping

	Gravel Pit		Refuse tip or slag heap
	Rock		Rock (scattered)
	Boulders		Boulders (scattered)
	Shingle		Mud
	Sand		Sand Pit
	Slopes		Top of cliff
	General detail		Underground detail
	Overhead detail		Narrow gauge railway
	Multi-track railway		Single track railway
	County boundary (England only)		Civil, parish or community boundary
	District, Unitary, Metropolitan, London Borough boundary		Constituency boundary
	Area of wooded vegetation		Non-coniferous trees
	Non-coniferous trees (scattered)		Coniferous trees
	Coniferous trees (scattered)		Positioned tree
	Orchard		Coppice or Osiers
	Rough Grassland		Heath
	Scrub		Marsh, Salt Marsh or Reeds
	Water feature		Flow arrows
	MHW(S) Mean high water (springs)		MLW(S) Mean low water (springs)
	Telephone line (where shown)		Electricity transmission line (with poles)
	Bench mark (where shown)		Triangulation station
	Point feature (e.g. Guide Post or Mile Stone)		Pylon, flare stack or lighting tower
	Site of (antiquity)		Glasshouse
	General Building		Important Building

Envirocheck®

LANDMARK INFORMATION GROUP®

Historical Mapping & Photography included:

Mapping Type	Scale	Date	Pg
Yorkshire	1:10,560	1855	2
Yorkshire	1:10,560	1892	3
Yorkshire	1:10,560	1911	4
Yorkshire	1:10,560	1951 - 1953	5
Ordnance Survey Plan	1:10,000	1956	6
Ordnance Survey Plan	1:10,000	1978	7
Ordnance Survey Plan	1:10,000	1983	8
10K Raster Mapping	1:10,000	1999	9
Street View	Variable		10

Historical Map - Slice C

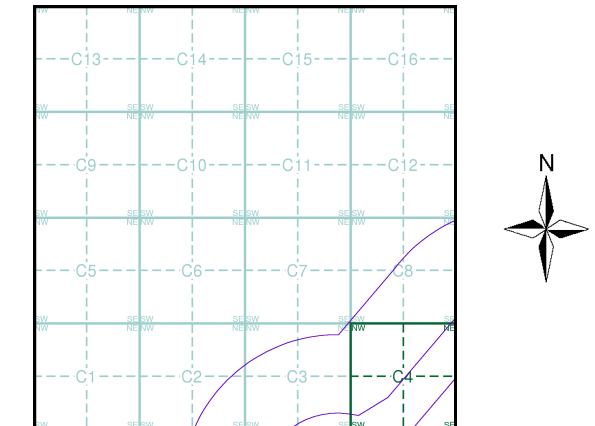

Order Details

Order Number: 201127555_1_1
 Customer Ref: PB8783-103-105
 National Grid Reference: 501460, 447610
 Slice: C
 Site Area (Ha): 62.79
 Search Buffer (m): 1000

Site Details

Hornsea Route

Landmark
 INFORMATION GROUP

Tel: 0844 844 9952
 Fax: 0844 844 9951
 Web: www.envirocheck.co.uk

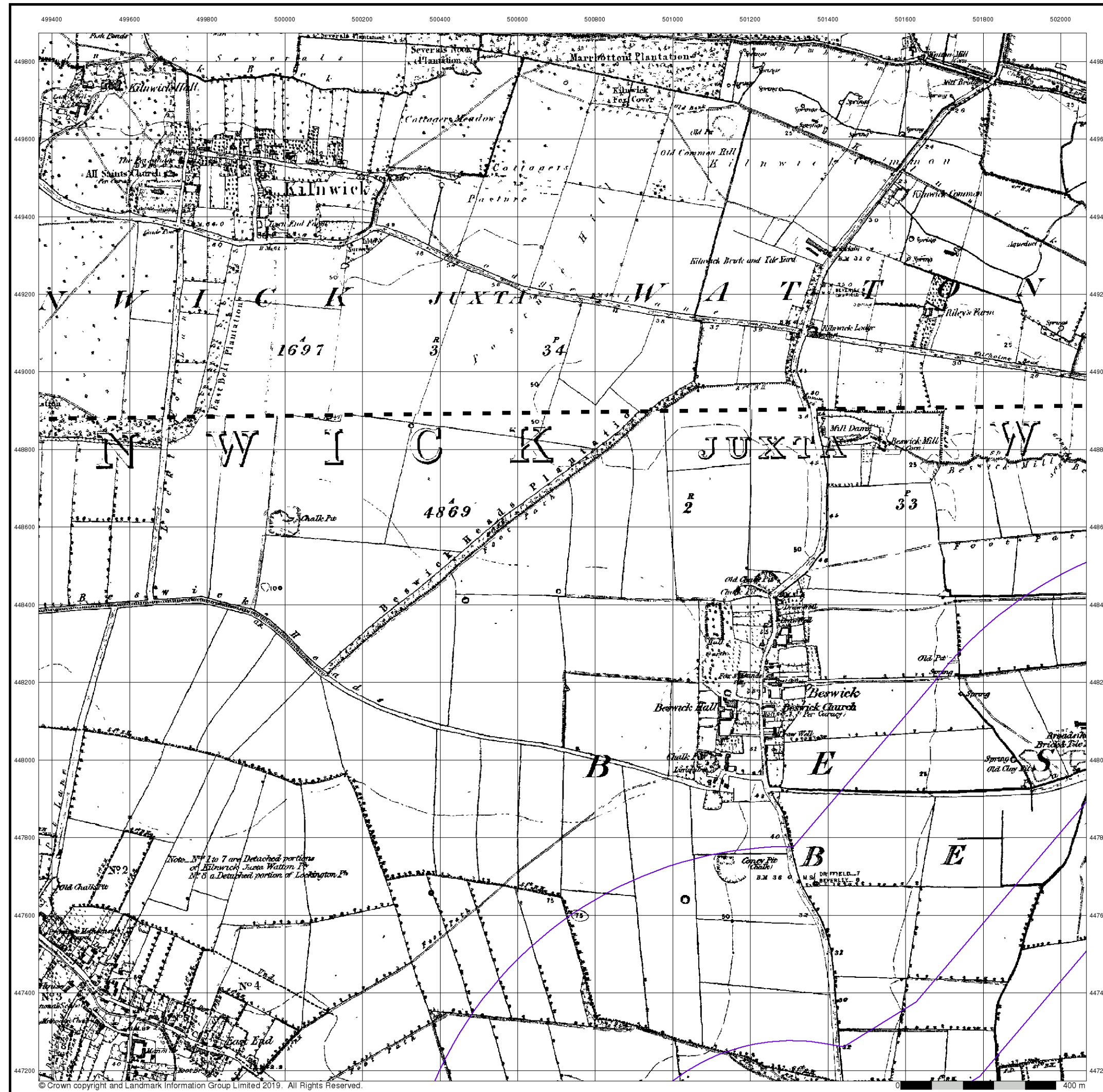

The historical maps shown were reproduced from maps predominantly held at the scale adopted for England, Wales and Scotland in the 1840's. In 1854 the 1:2,500 scale was adopted for mapping urban areas; these maps were used to update the 1:10,560 maps. The published date given therefore is often some years later than the surveyed date. Before 1938, all OS maps were based on the Cassini Projection, with independent surveys of a single county or group of counties, giving rise to significant inaccuracies in outlying areas. In the late 1940's, a Provisional Edition was produced, which updated the 1:10,560 mapping from a number of sources. The maps appear unfinished - with all military camps and other strategic sites removed. These maps were initially overprinted with the National Grid. In 1970, the first 1:10,000 maps were produced using the Transverse Mercator Projection. The revision process continued until recently, with new editions appearing every 10 years or so for urban areas.

Map Name(s) and Date(s)

17800	1855	1:10,560
19500	1855	1:10,560

Historical Map - Slice C

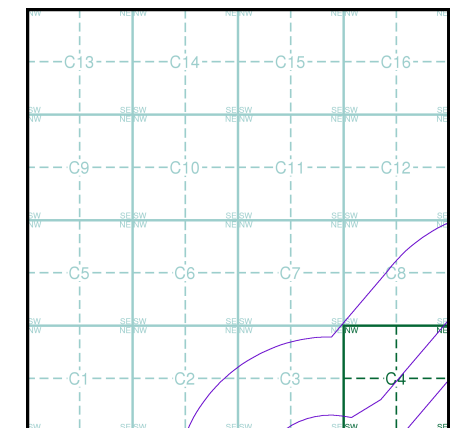

Order Details

Order Number: 201127555_1_1
 Customer Ref: PB8783-103-105
 National Grid Reference: 501460, 447610
 Slice: C
 Site Area (Ha): 62.79
 Search Buffer (m): 1000

Site Details

Hornsea Route

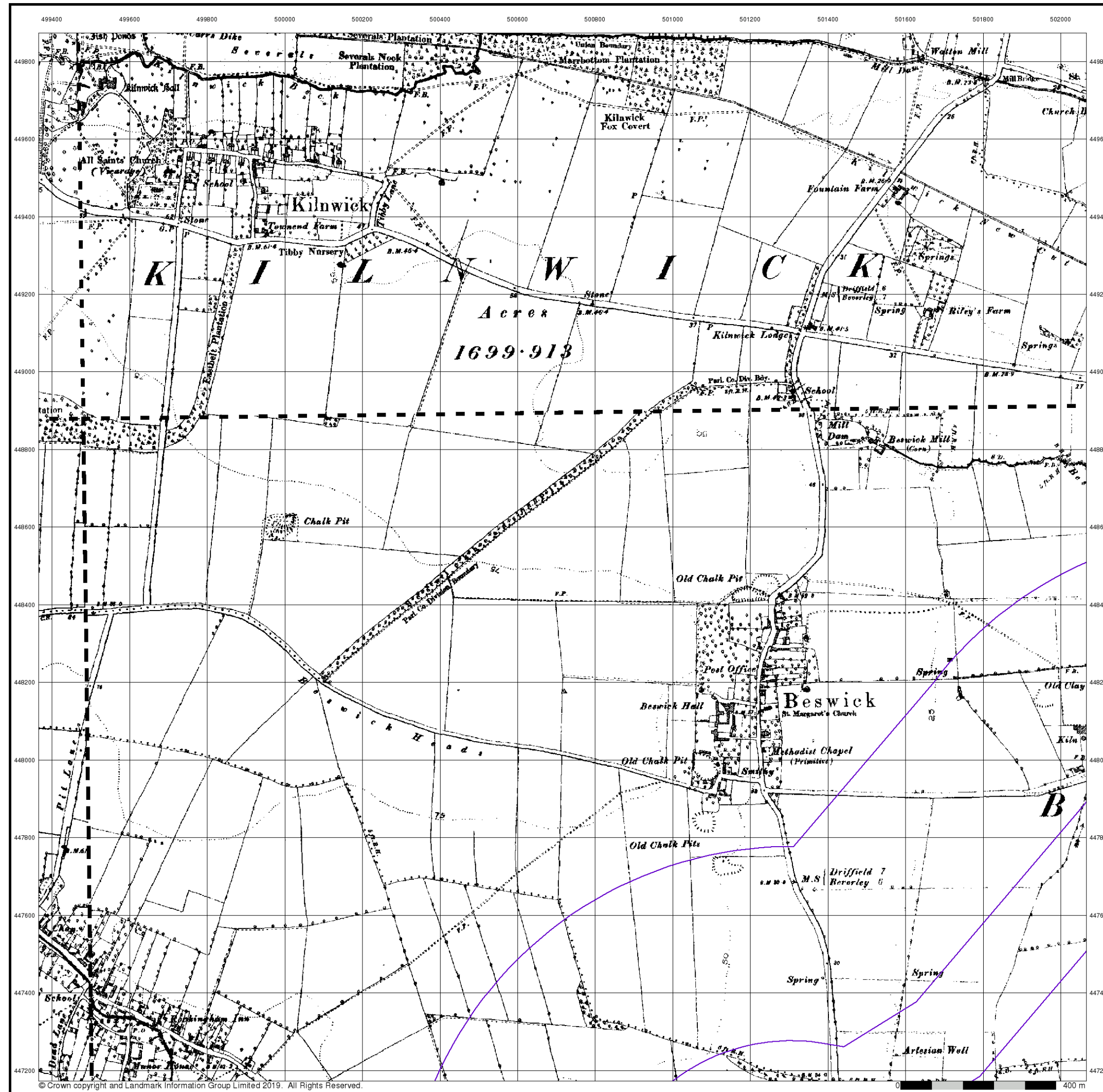

Envirocheck®

LANDMARK INFORMATION GROUP®

Yorkshire

Published 1892

Source map scale - 1:10,560

The historical maps shown were reproduced from maps predominantly held at the scale adopted for England, Wales and Scotland in the 1840's. In 1854 the 1:2,500 scale was adopted for mapping urban areas; these maps were used to update the 1:10,560 maps. The published date given therefore is often some years later than the surveyed date. Before 1938, all OS maps were based on the Cassini Projection, with independent surveys of a single county or group of counties, giving rise to significant inaccuracies in outlying areas. In the late 1940's, a Provisional Edition was produced, which updated the 1:10,560 mapping from a number of sources. The maps appear unfinished - with all military camps and other strategic sites removed. These maps were initially overprinted with the National Grid. In 1970, the first 1:10,000 maps were produced using the Transverse Mercator Projection. The revision process continued until recently, with new editions appearing every 10 years or so for urban areas.

Map Name(s) and Date(s)

178SW 1892 1:10,560	178SE 1892 1:10,560
195NW 1892 1:10,560	195NE 1892 1:10,560

Historical Map - Slice C

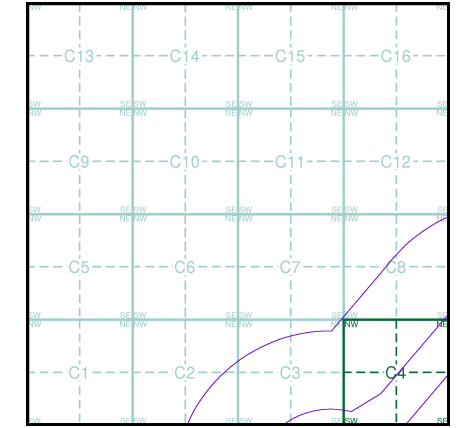

Order Details

Order Number: 201127555_1_1
 Customer Ref: PB8783-103-105
 National Grid Reference: 501460, 447610
 Slice: C
 Site Area (Ha): 62.79
 Search Buffer (m): 1000

Site Details

Hornsea Route

Landmark
 INFORMATION GROUP

Tel: 0844 844 9952
 Fax: 0844 844 9951
 Web: www.envirocheck.co.uk

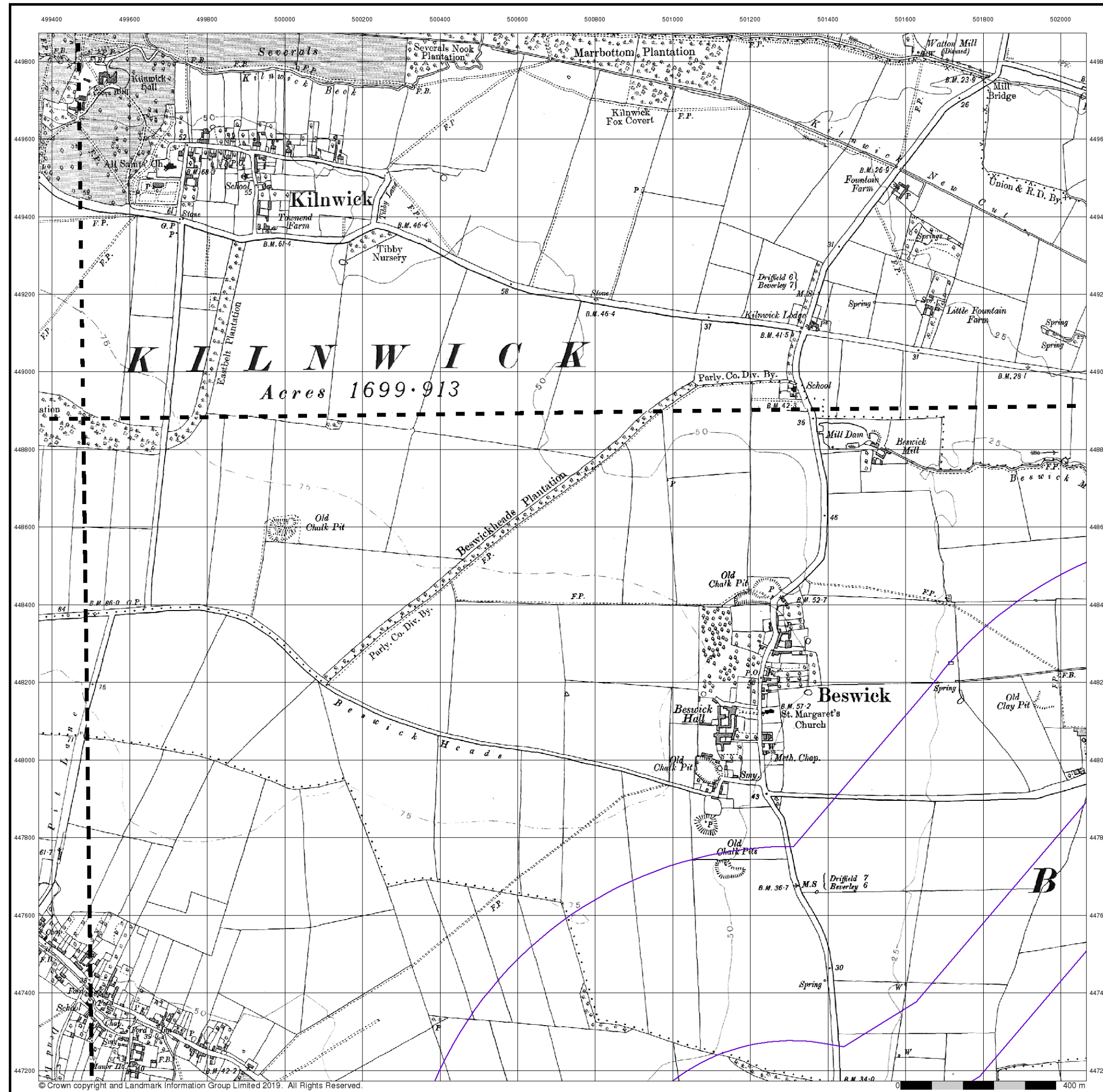

Envirocheck®

LANDMARK INFORMATION GROUP®

Yorkshire

Published 1911

Source map scale - 1:10,560

The historical maps shown were reproduced from maps predominantly held at the scale adopted for England, Wales and Scotland in the 1840's. In 1854 the 1:2,500 scale was adopted for mapping urban areas; these maps were used to update the 1:10,560 maps. The published date given therefore is often some years later than the surveyed date. Before 1938, all OS maps were based on the Cassini Projection, with independent surveys of a single county or group of counties, giving rise to significant inaccuracies in outlying areas. In the late 1940's, a Provisional Edition was produced, which updated the 1:10,560 mapping from a number of sources. The maps appear unfinished - with all military camps and other strategic sites removed. These maps were initially overprinted with the National Grid. In 1970, the first 1:10,000 maps were produced using the Transverse Mercator Projection. The revision process continued until recently, with new editions appearing every 10 years or so for urban areas.

Map Name(s) and Date(s)

178SW 1911 1:10,560	178SE 1911 1:10,560
195NW 1911 1:10,560	195NE 1911 1:10,560

Historical Map - Slice C

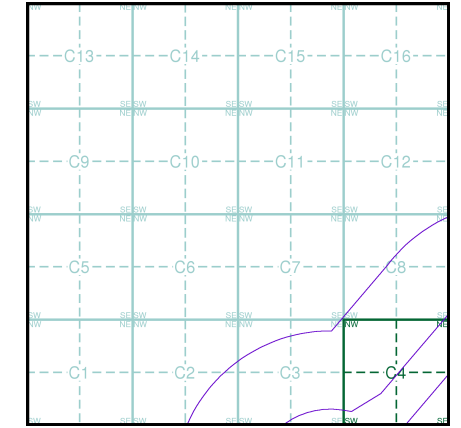

Order Details

Order Number: 201127555_1_1
 Customer Ref: PB8783-103-105
 National Grid Reference: 501460, 447610
 Slice: C
 Site Area (Ha): 62.79
 Search Buffer (m): 1000

Site Details

Hornsea Route

Landmark
 INFORMATION GROUP

Tel: 0844 844 9952
 Fax: 0844 844 9951
 Web: www.envirocheck.co.uk

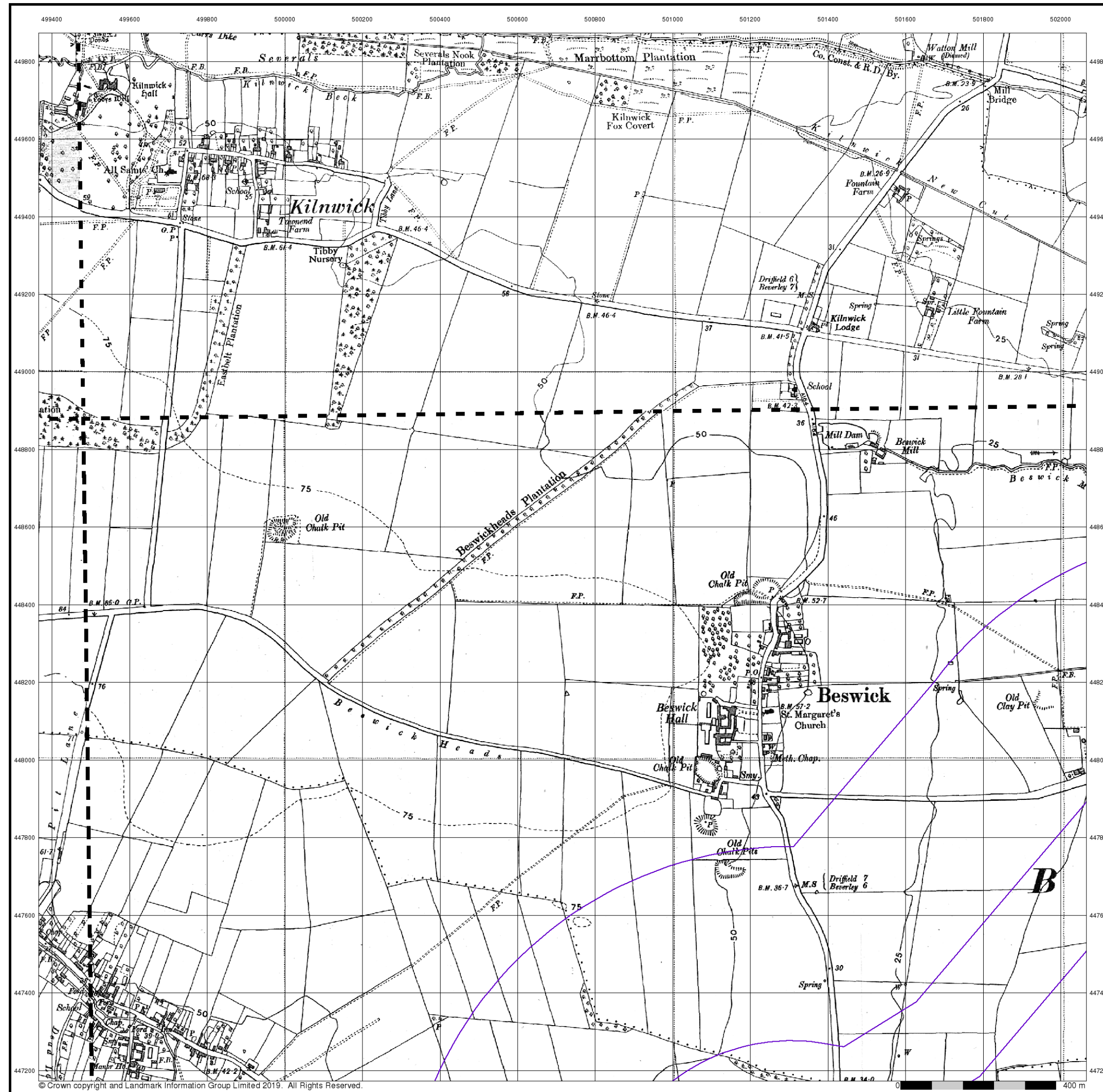

Envirocheck

LANDMARK INFORMATION GROUP

Yorkshire

Published 1951 - 1953

Source map scale - 1:10,560

The historical maps shown were reproduced from maps predominantly held at the scale adopted for England, Wales and Scotland in the 1840's. In 1854 the 1:2,500 scale was adopted for mapping urban areas; these maps were used to update the 1:10,560 maps. The published date given therefore is often some years later than the surveyed date. Before 1938, all OS maps were based on the Cassini Projection, with independent surveys of a single county or group of counties, giving rise to significant inaccuracies in outlying areas. In the late 1940's, a Provisional Edition was produced, which updated the 1:10,560 mapping from a number of sources. The maps appear unfinished - with all military camps and other strategic sites removed. These maps were initially overprinted with the National Grid. In 1970, the first 1:10,000 maps were produced using the Transverse Mercator Projection. The revision process continued until recently, with new editions appearing every 10 years or so for urban areas.

Map Name(s) and Date(s)

178SW 1953 1:10,560	178SE 1951 1:10,560
195NW 1952 1:10,560	195NE 1951 1:10,560

Historical Map - Slice C

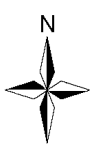
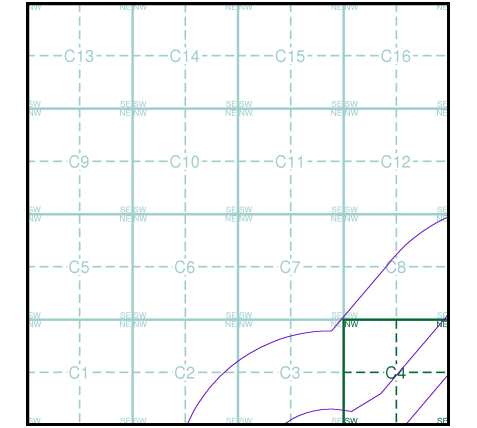

Order Details

Order Number: 201127555_1_1
 Customer Ref: PB8783-103-105
 National Grid Reference: 501460, 447610
 Slice: C
 Site Area (Ha): 62.79
 Search Buffer (m): 1000

Site Details

Hornsea Route

Landmark
 INFORMATION GROUP

Tel: 0844 844 9952
 Fax: 0844 844 9951
 Web: www.envirocheck.co.uk

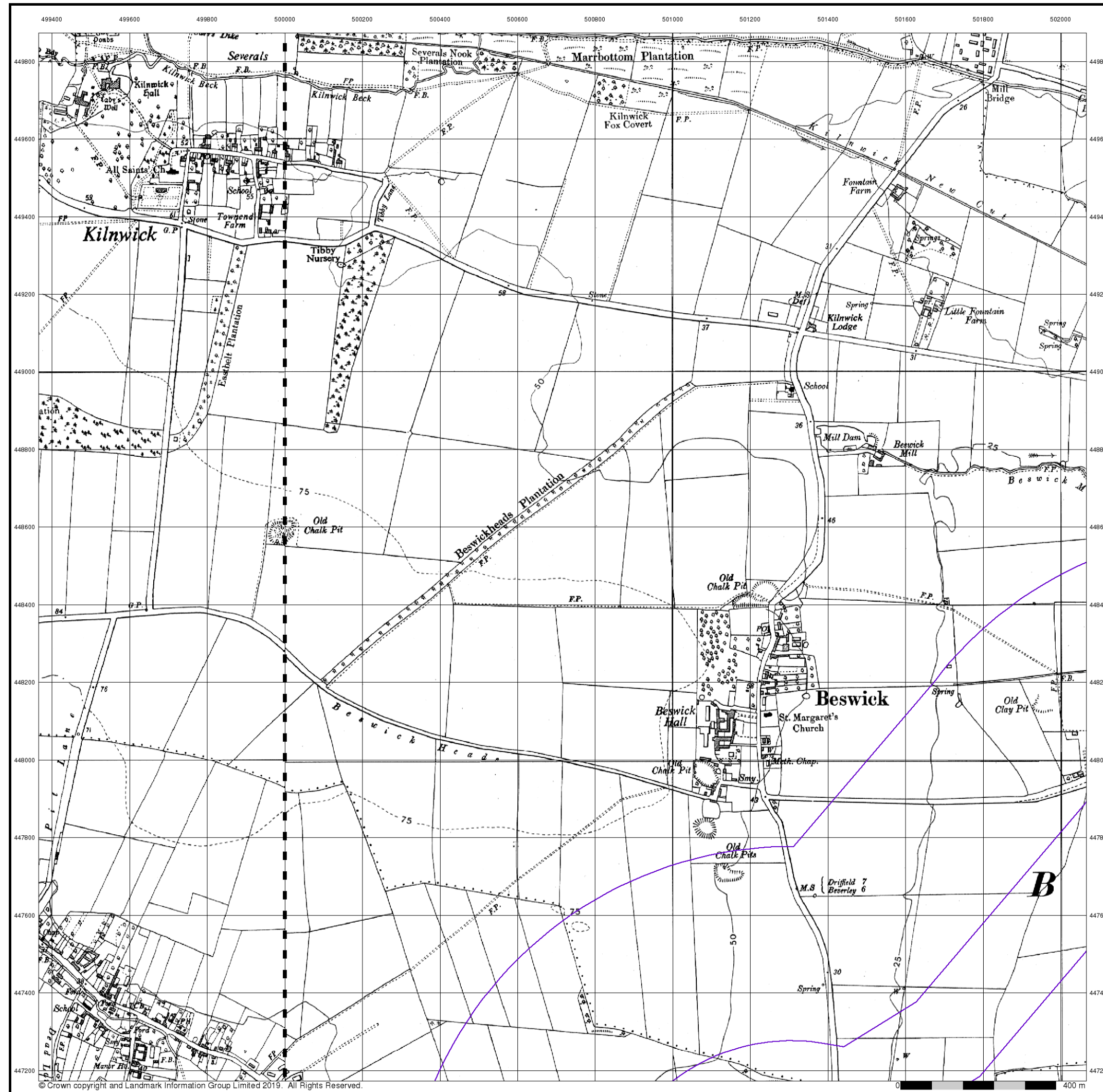

Envirocheck®

● LANDMARK INFORMATION GROUP®

Ordnance Survey Plan

Published 1956

Source map scale - 1:10,000

The historical maps shown were reproduced from maps predominantly held at the scale adopted for England, Wales and Scotland in the 1840's. In 1854 the 1:2,500 scale was adopted for mapping urban areas; these maps were used to update the 1:10,560 maps. The published date given therefore is often some years later than the surveyed date. Before 1938, all OS maps were based on the Cassini Projection, with independent surveys of a single county or group of counties, giving rise to significant inaccuracies in outlying areas. In the late 1940's, a Provisional Edition was produced, which updated the 1:10,560 mapping from a number of sources. The maps appear unfinished - with all military camps and other strategic sites removed. These maps were initially overprinted with the National Grid. In 1970, the first 1:10,000 maps were produced using the Transverse Mercator Projection. The revision process continued until recently, with new editions appearing every 10 years or so for urban areas.

Map Name(s) and Date(s)

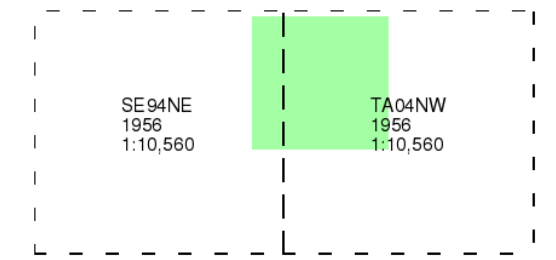

Historical Map - Slice C

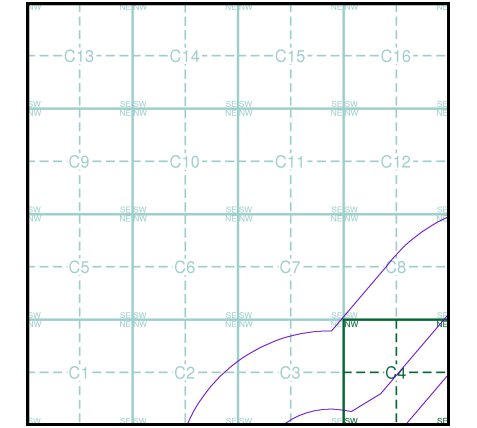

Order Details

Order Number: 201127555_1_1
 Customer Ref: PB8783-103-105
 National Grid Reference: 501460, 447610
 Slice: C
 Site Area (Ha): 62.79
 Search Buffer (m): 1000

Site Details

Hornsea Route

Landmark
 ●●● INFORMATION GROUP

Tel: 0844 844 9952
 Fax: 0844 844 9951
 Web: www.envirocheck.co.uk

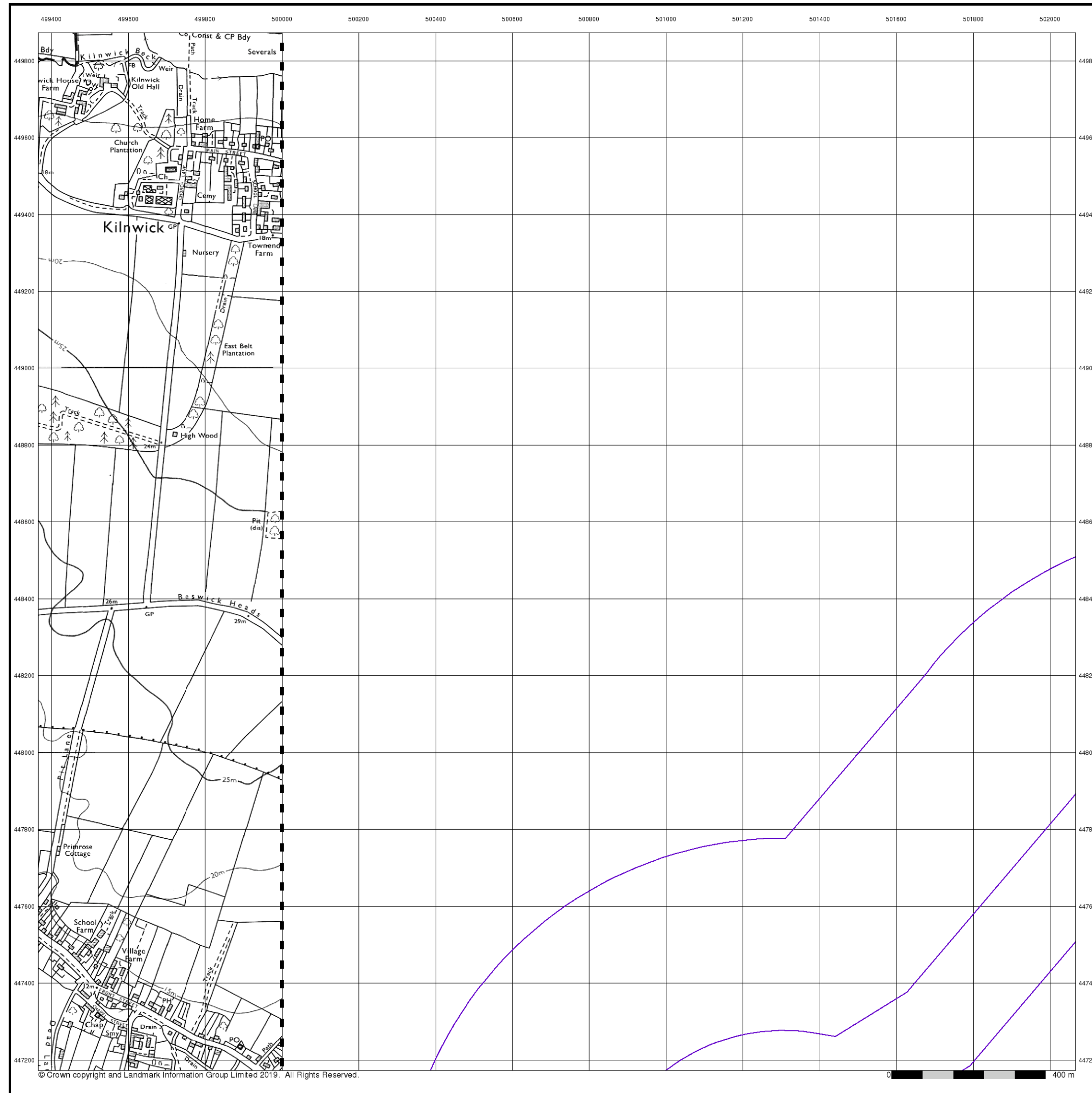

© Crown copyright and Landmark Information Group Limited 2019. All Rights Reserved.

Envirocheck®

LANDMARK INFORMATION GROUP®

Ordnance Survey Plan

Published 1978

Source map scale - 1:10,000

The historical maps shown were reproduced from maps predominantly held at the scale adopted for England, Wales and Scotland in the 1840's. In 1854 the 1:2,500 scale was adopted for mapping urban areas; these maps were used to update the 1:10,560 maps. The published date given therefore is often some years later than the surveyed date. Before 1938, all OS maps were based on the Cassini Projection, with independent surveys of a single county or group of counties, giving rise to significant inaccuracies in outlying areas. In the late 1940's, a Provisional Edition was produced, which updated the 1:10,560 mapping from a number of sources. The maps appear unfinished - with all military camps and other strategic sites removed. These maps were initially overprinted with the National Grid. In 1970, the first 1:10,000 maps were produced using the Transverse Mercator Projection. The revision process continued until recently, with new editions appearing every 10 years or so for urban areas.

Map Name(s) and Date(s)

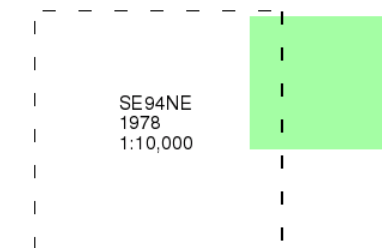

Historical Map - Slice C

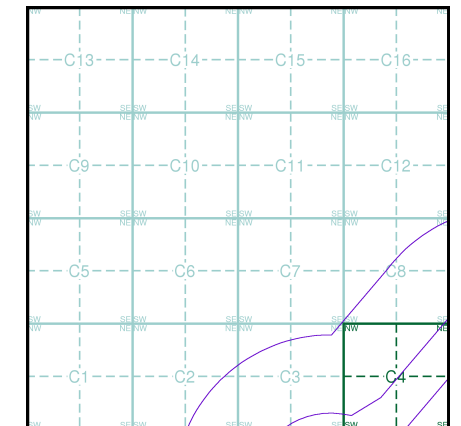

Order Details

Order Number: 201127555_1_1
 Customer Ref: PB8783-103-105
 National Grid Reference: 501460, 447610
 Slice: C
 Site Area (Ha): 62.79
 Search Buffer (m): 1000

Site Details

Hornsea Route

Landmark
 INFORMATION GROUP

Tel: 0844 844 9952
 Fax: 0844 844 9951
 Web: www.envirocheck.co.uk

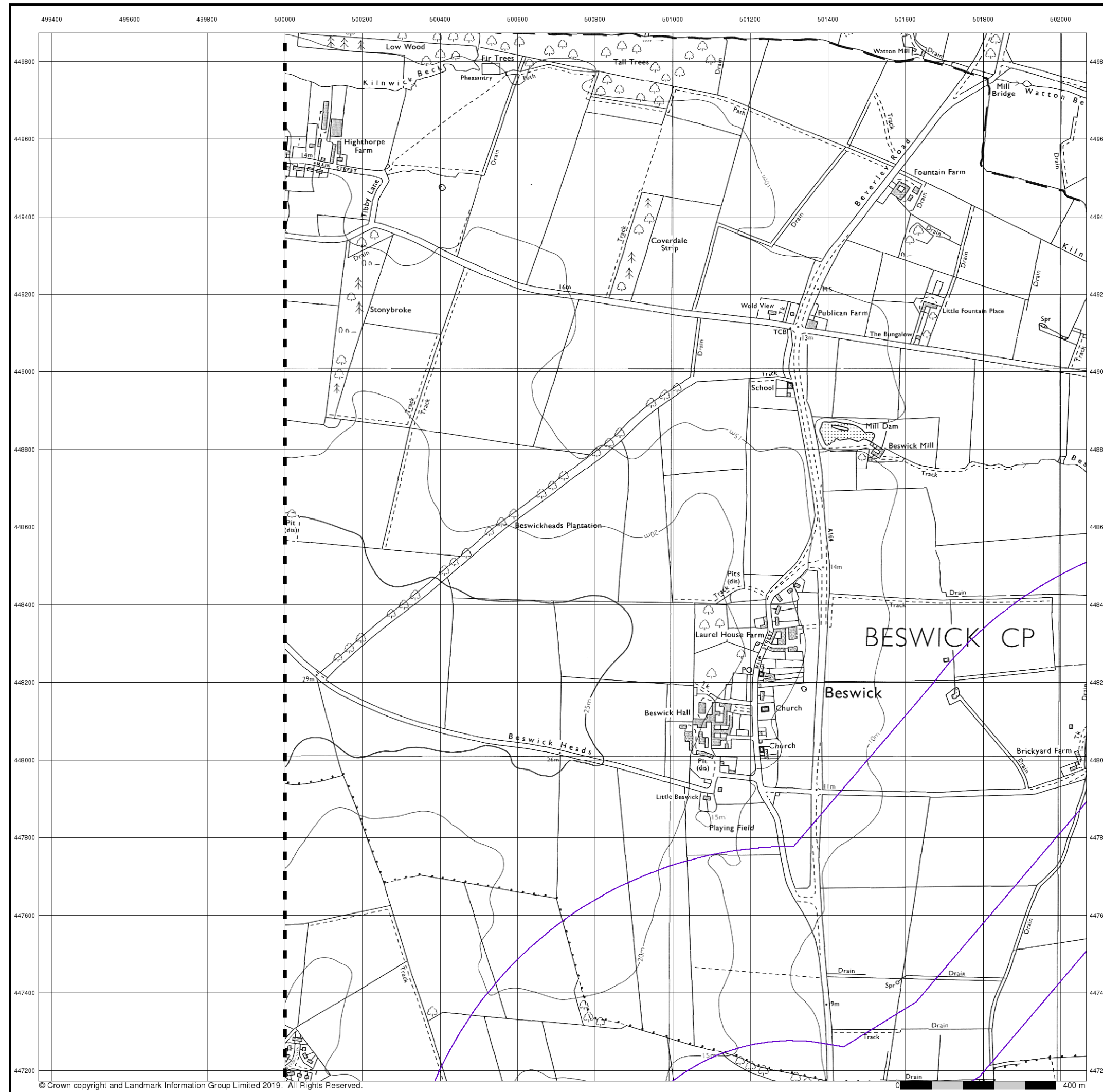

Ordnance Survey Plan

Published 1983

Source map scale - 1:10,000

The historical maps shown were reproduced from maps predominantly held at the scale adopted for England, Wales and Scotland in the 1840's. In 1854 the 1:2,500 scale was adopted for mapping urban areas; these maps were used to update the 1:10,560 maps. The published date given therefore is often some years later than the surveyed date. Before 1938, all OS maps were based on the Cassini Projection, with independent surveys of a single county or group of counties, giving rise to significant inaccuracies in outlying areas. In the late 1940's, a Provisional Edition was produced, which updated the 1:10,560 mapping from a number of sources. The maps appear unfinished - with all military camps and other strategic sites removed. These maps were initially overprinted with the National Grid. In 1970, the first 1:10,000 maps were produced using the Transverse Mercator Projection. The revision process continued until recently, with new editions appearing every 10 years or so for urban areas.

Map Name(s) and Date(s)

TA04NW
1983
1:10,000

Historical Map - Slice C

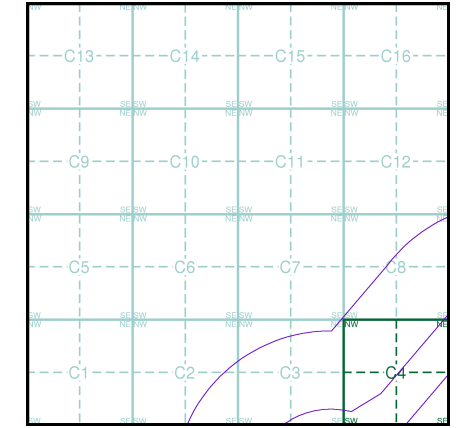

Order Details

Order Number: 201127555_1_1
 Customer Ref: PB8783-103-105
 National Grid Reference: 501460, 447610
 Slice: C
 Site Area (Ha): 62.79
 Search Buffer (m): 1000

Site Details

Horsea Route

10k Raster Mapping

Published 1999

Source map scale - 1:10,000

The historical maps shown were produced from the Ordnance Survey's 1:10,000 colour raster mapping. These maps are derived from Landplan which replaced the old 1:10,000 maps originally published in 1970. The data is highly detailed showing buildings, fences and field boundaries as well as all roads, tracks and paths. Road names are also included together with the relevant road number and classification. Boundary information depiction includes county, unitary authority, district, civil parish and constituency.

Map Name(s) and Date(s)

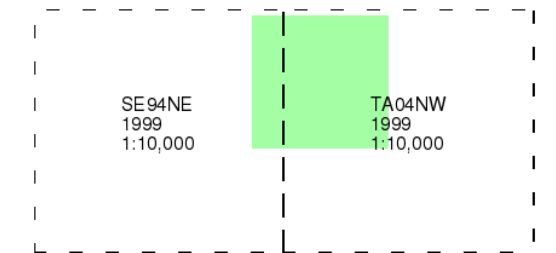

Historical Map - Slice C

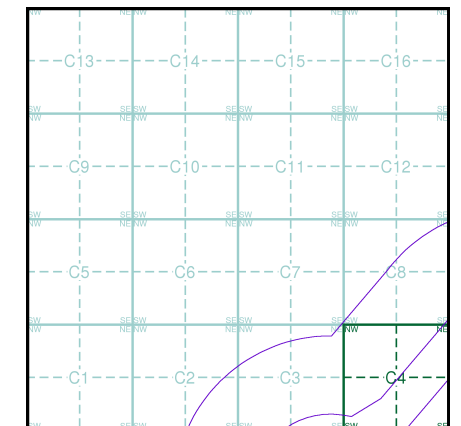

Order Details

Order Number: 201127555_1_1
 Customer Ref: PB8783-103-105
 National Grid Reference: 501460, 447610
 Slice: C
 Site Area (Ha): 62.79
 Search Buffer (m): 1000

Site Details

Hornsea Route

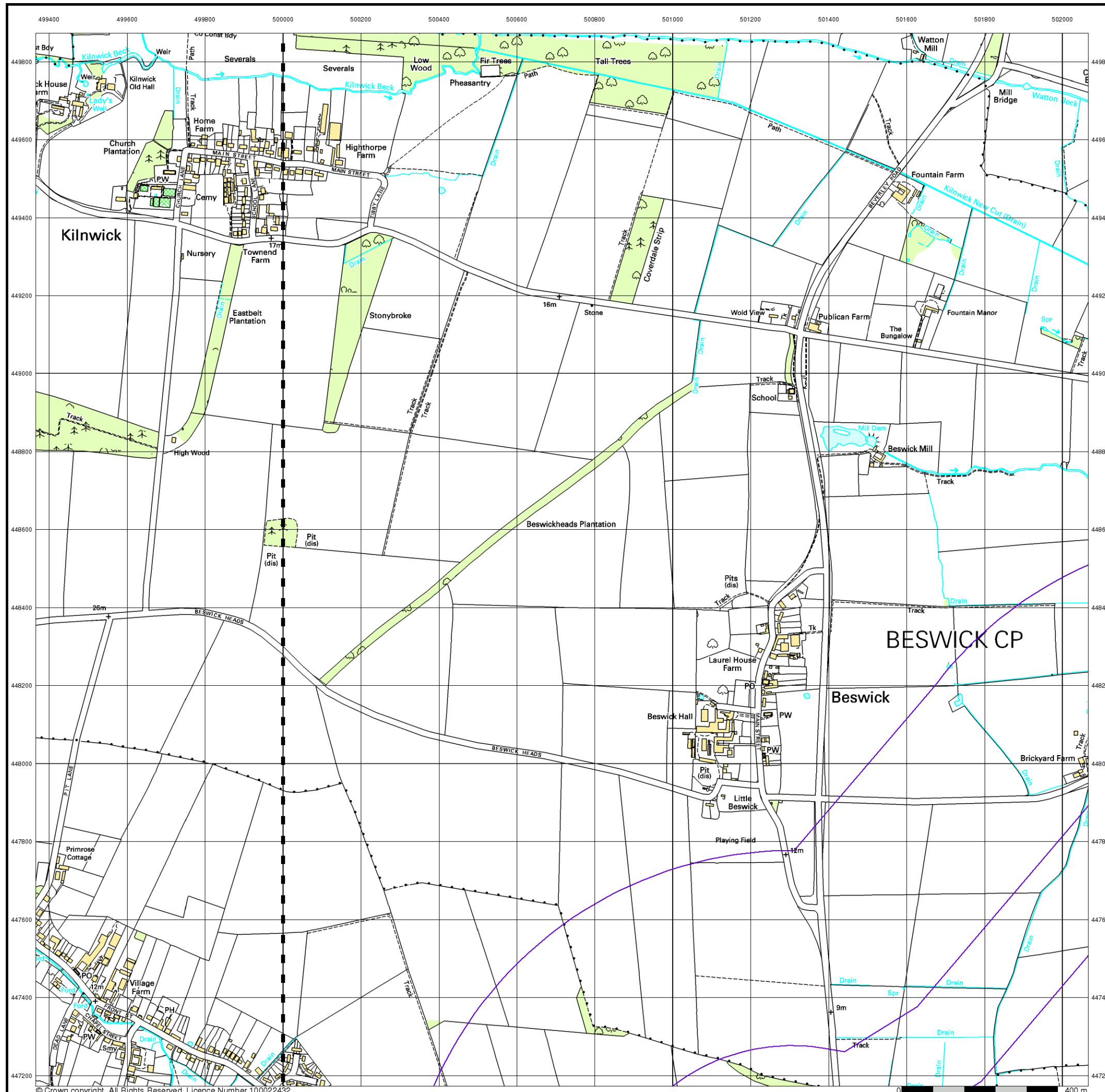

Street View

Published 2019

Source map scale - 1:10,000

Street View is a street-level map for the whole of Great Britain produced by the Ordnance Survey. These maps are provided at a nominal scale of 1:10,000

Map Name(s) and Date(s)



Street View Map - Slice C

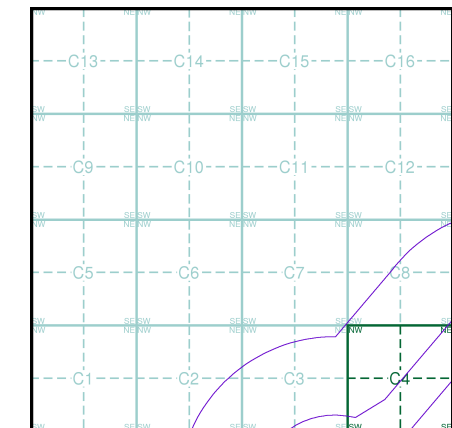

Order Details

Order Number: 201127555_1_1
 Customer Ref: PB8783-103-105
 National Grid Reference: 501460, 447610
 Slice: C
 Site Area (Ha): 62.79
 Search Buffer (m): 1000

Site Details

Hornsea Route

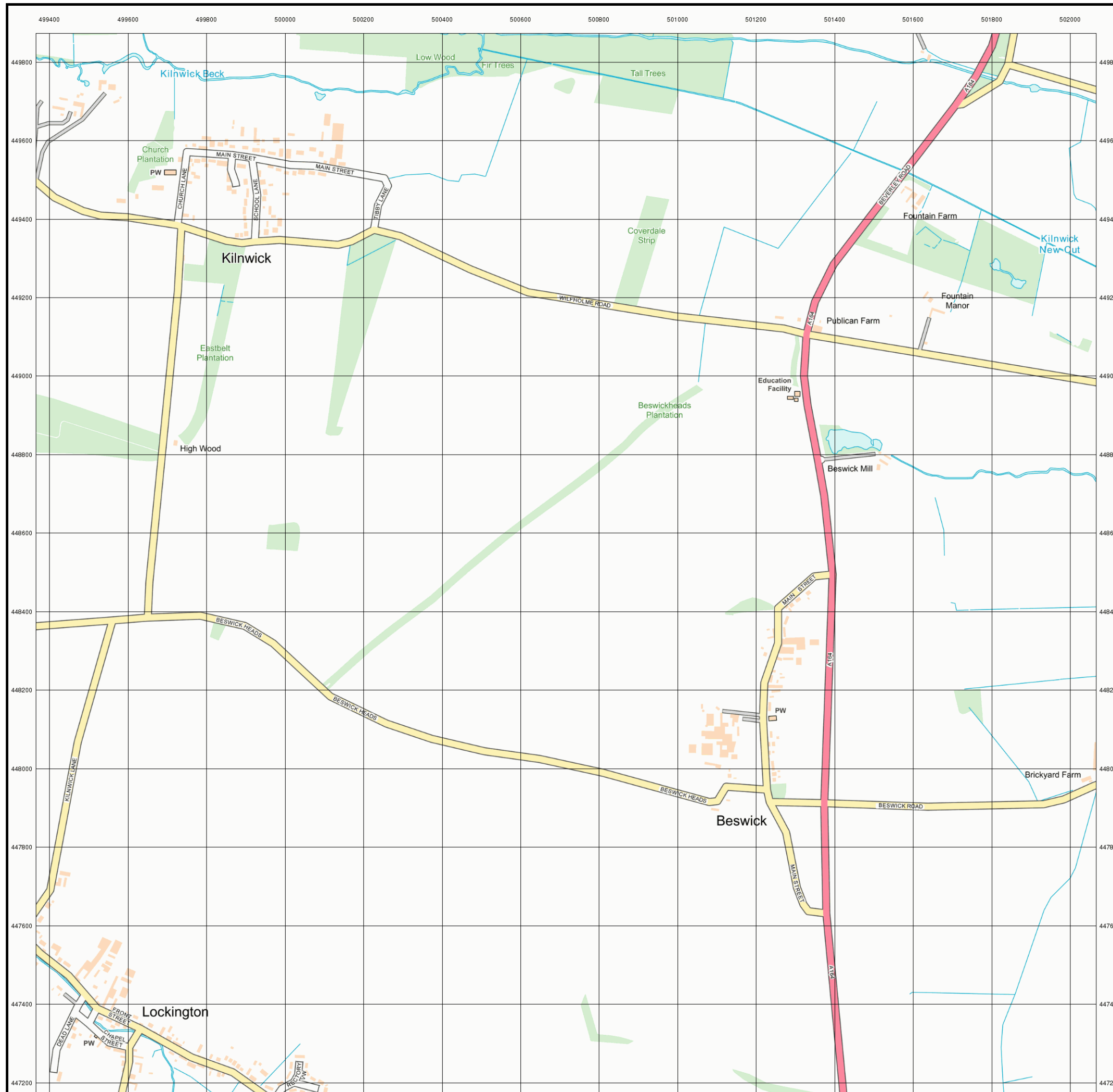

Historical Mapping Legends

Ordnance Survey County Series 1:10,560

- Gravel Pit
- Sand Pit
- Other Pits
- Quarry
- Shingle
- Orchard
- Osiers
- Reeds
- Marsh
- Mixed Wood
- Deciduous
- Brushwood
- Fir
- Furze
- Rough Pasture
- Arrow denotes flow of water
- Trigonometrical Station
- Site of Antiquities
- Bench Mark
- Pump, Guide Post, Signal Post
- Well, Spring, Boundary Post
- 285** Surface Level
- Sketched Contour
- Instrumental Contour
- Main Roads
- Minor Roads
- Sunken Road
- Raised Road
- Road over Railway
- Railway over River
- Railway over Road
- Level Crossing
- Road over River or Canal
- Road over Stream
- Road over Stream
- County Boundary (Geographical)
- County & Civil Parish Boundary
- Administrative County & Civil Parish Boundary
- Co. Boro. Bdy. County Borough Boundary (England)
- Co. Burgh Bdy. County Burgh Boundary (Scotland)
- R.D. Bdy. Rural District Boundary
- Civil Parish Boundary

Ordnance Survey Plan 1:10,000

- Chalk Pit, Clay Pit or Quarry
- Gravel Pit
- Sand Pit
- Disused Pit or Quarry
- Refuse or Slag Heap
- Lake, Loch or Pond
- Dunes
- Boulders
- Coniferous Trees
- Non-Coniferous Trees
- Orchard
- Scrub
- Coppice
- Bracken
- Heath
- Rough Grassland
- Marsh
- Reeds
- Saltings
- Building
- Glasshouse
- Sloping Masonry
- Pylon
- Electricity Transmission Line
- Pole
- Cutting
- Embankment
- Standard Gauge Multiple Track
- Standard Gauge Single Track
- Siding, Tramway or Mineral Line
- Narrow Gauge
- Geographical County
- Administrative County, County Borough or County of City
- Municipal Borough, Urban or Rural District, Burgh or District Council
- Borough, Burgh or County Constituency
- Civil Parish
- BP, BS
- Ch
- CH
- F E Sta
- FB
- Fn
- GP
- MP
- MS
- Pol Sta
- PO
- PC
- PH
- SB
- Spr
- TCB
- TCP
- W

1:10,000 Raster Mapping

- Gravel Pit
- Rock
- Boulders
- Shingle
- Sand
- Slopes
- General detail
- Overhead detail
- Multi-track railway
- County boundary (England only)
- District, Unitary, Metropolitan, London Borough boundary
- Area of wooded vegetation
- Non-coniferous trees (scattered)
- Coniferous trees (scattered)
- Orchard
- Rough Grassland
- Scrub
- Water feature
- MHW(S) Mean high water (springs)
- BM 123.45 m
- Point feature (e.g. Guide Post or Mile Stone)
- Site of (antiquity)
- General Building
- Refuse tip or slag heap
- Rock (scattered)
- Boulders (scattered)
- Mud
- Sand Pit
- Top of cliff
- Underground detail
- Narrow gauge railway
- Single track railway
- Civil, parish or community boundary
- Constituency boundary
- Non-coniferous trees
- Coniferous trees
- Positioned tree
- Coppice or Osiers
- Heath
- Marsh, Salt Marsh or Reeds
- Flow arrows
- MLW(S) Mean low water (springs)
- Triangulation station
- Pylon, flare stack or lighting tower
- Glasshouse
- Important Building

Envirocheck

LANDMARK INFORMATION GROUP

Historical Mapping & Photography included:

Mapping Type	Scale	Date	Pg
Yorkshire	1:10,560	1854	2
Yorkshire	1:10,560	1893	3
Yorkshire	1:10,560	1911	4
Yorkshire	1:10,560	1928	5
Yorkshire	1:10,560	1938	6
Yorkshire	1:10,560	1951	7
Ordnance Survey Plan	1:10,000	1956	8
Ordnance Survey Plan	1:10,000	1970 - 1975	9
Ordnance Survey Plan	1:10,000	1982	10
Ordnance Survey Plan	1:10,000	1993 - 1994	11
10K Raster Mapping	1:10,000	1999	12
Street View	Variable		13

Historical Map - Slice C

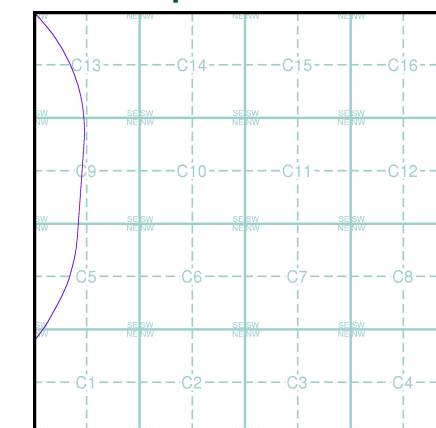

Order Details

Order Number: 201127560_1_1
 Customer Ref: PB8783-103-105
 National Grid Reference: 501530, 441210
 Slice: C
 Site Area (Ha): 53.73
 Search Buffer (m): 1000

Site Details

Hornsea Route

Landmark
 INFORMATION GROUP

Tel: 0844 844 9952
 Fax: 0844 844 9951
 Web: www.envirocheck.co.uk

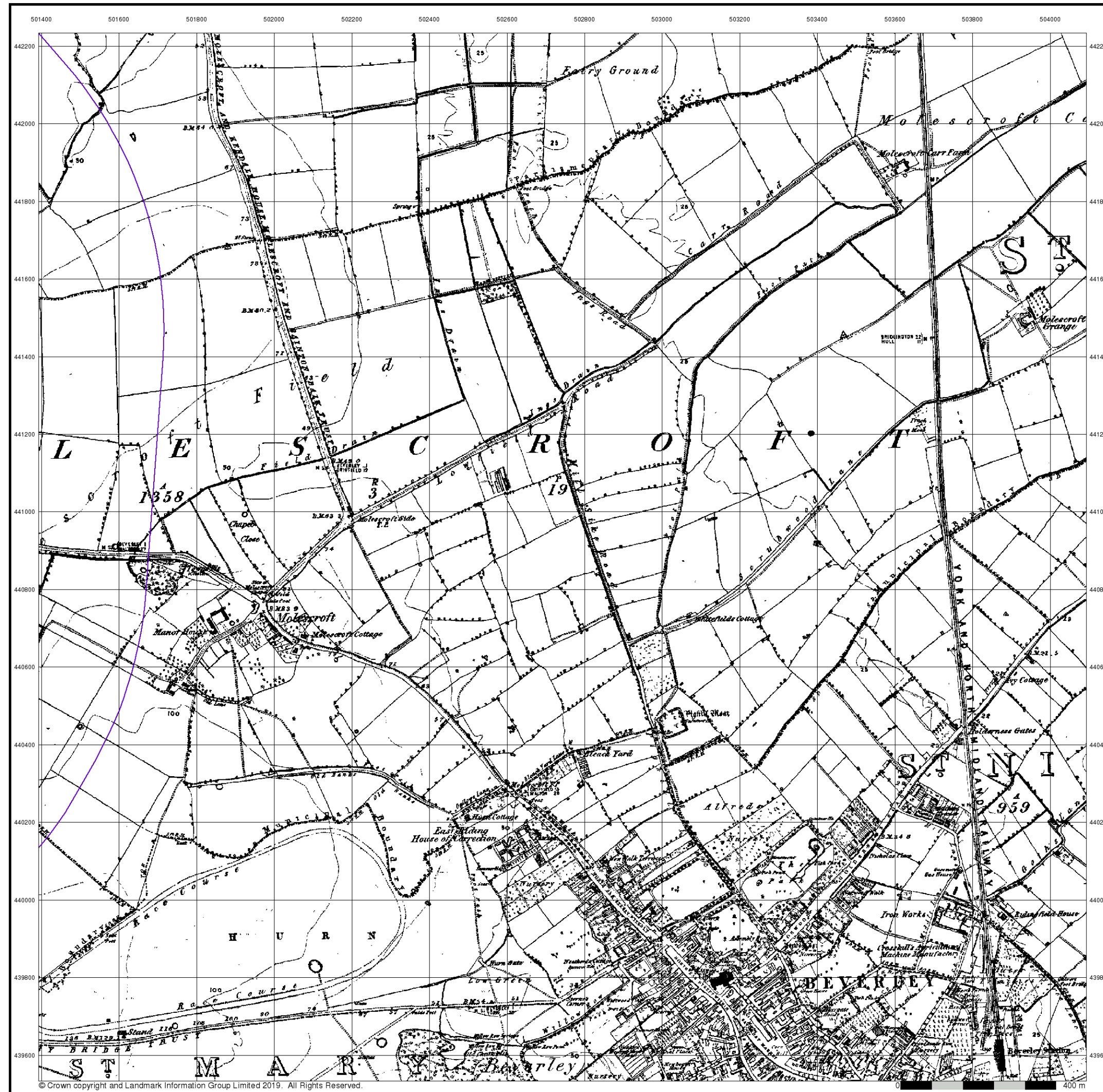

The historical maps shown were reproduced from maps predominantly held at the scale adopted for England, Wales and Scotland in the 1840's. In 1854 the 1:2,500 scale was adopted for mapping urban areas; these maps were used to update the 1:10,560 maps. The published date given therefore is often some years later than the surveyed date. Before 1938, all OS maps were based on the Cassini Projection, with independent surveys of a single county or group of counties, giving rise to significant inaccuracies in outlying areas. In the late 1940's, a Provisional Edition was produced, which updated the 1:10,560 mapping from a number of sources. The maps appear unfinished - with all military camps and other strategic sites removed. These maps were initially overprinted with the National Grid. In 1970, the first 1:10,000 maps were produced using the Transverse Mercator Projection. The revision process continued until recently, with new editions appearing every 10 years or so for urban areas.

Map Name(s) and Date(s)

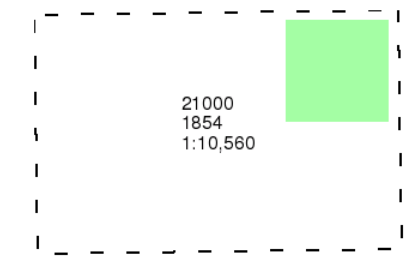

Historical Map - Slice C

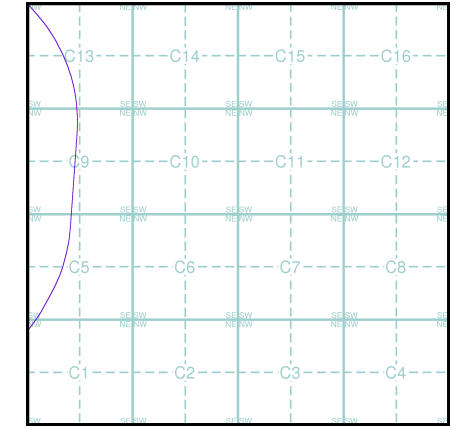

Order Details

Order Number: 201127560_1_1
 Customer Ref: PB8783-103-105
 National Grid Reference: 501530, 441210
 Slice: C
 Site Area (Ha): 53.73
 Search Buffer (m): 1000

Site Details

Horsea Route

The historical maps shown were reproduced from maps predominantly held at the scale adopted for England, Wales and Scotland in the 1840's. In 1854 the 1:2,500 scale was adopted for mapping urban areas; these maps were used to update the 1:10,560 maps. The published date given therefore is often some years later than the surveyed date. Before 1938, all OS maps were based on the Cassini Projection, with independent surveys of a single county or group of counties, giving rise to significant inaccuracies in outlying areas. In the late 1940's, a Provisional Edition was produced, which updated the 1:10,560 mapping from a number of sources. The maps appear unfinished - with all military camps and other strategic sites removed. These maps were initially overprinted with the National Grid. In 1970, the first 1:10,000 maps were produced using the Transverse Mercator Projection. The revision process continued until recently, with new editions appearing every 10 years or so for urban areas.

Map Name(s) and Date(s)

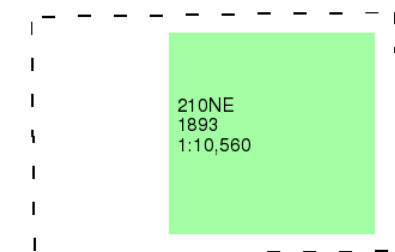

Historical Map - Slice C

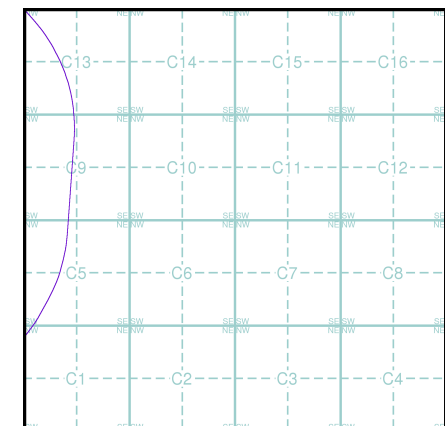

Order Details

Order Number: 201127560_1_1
Customer Ref: PB8783-103-105
National Grid Reference: 501530, 441210
Slice: C
Site Area (Ha): 53.73
Search Buffer (m): 1000

Site Details

Hornsea Route

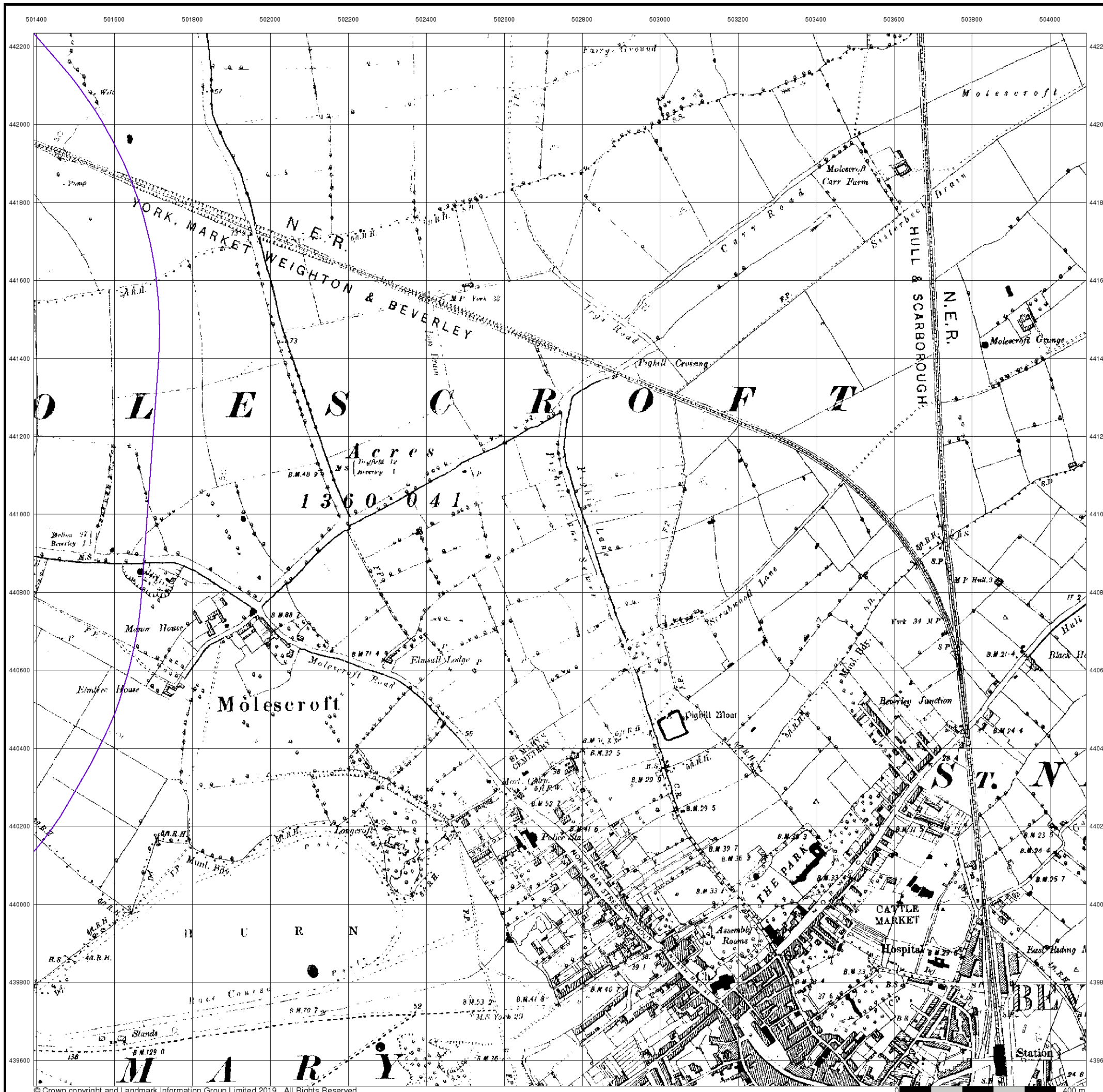

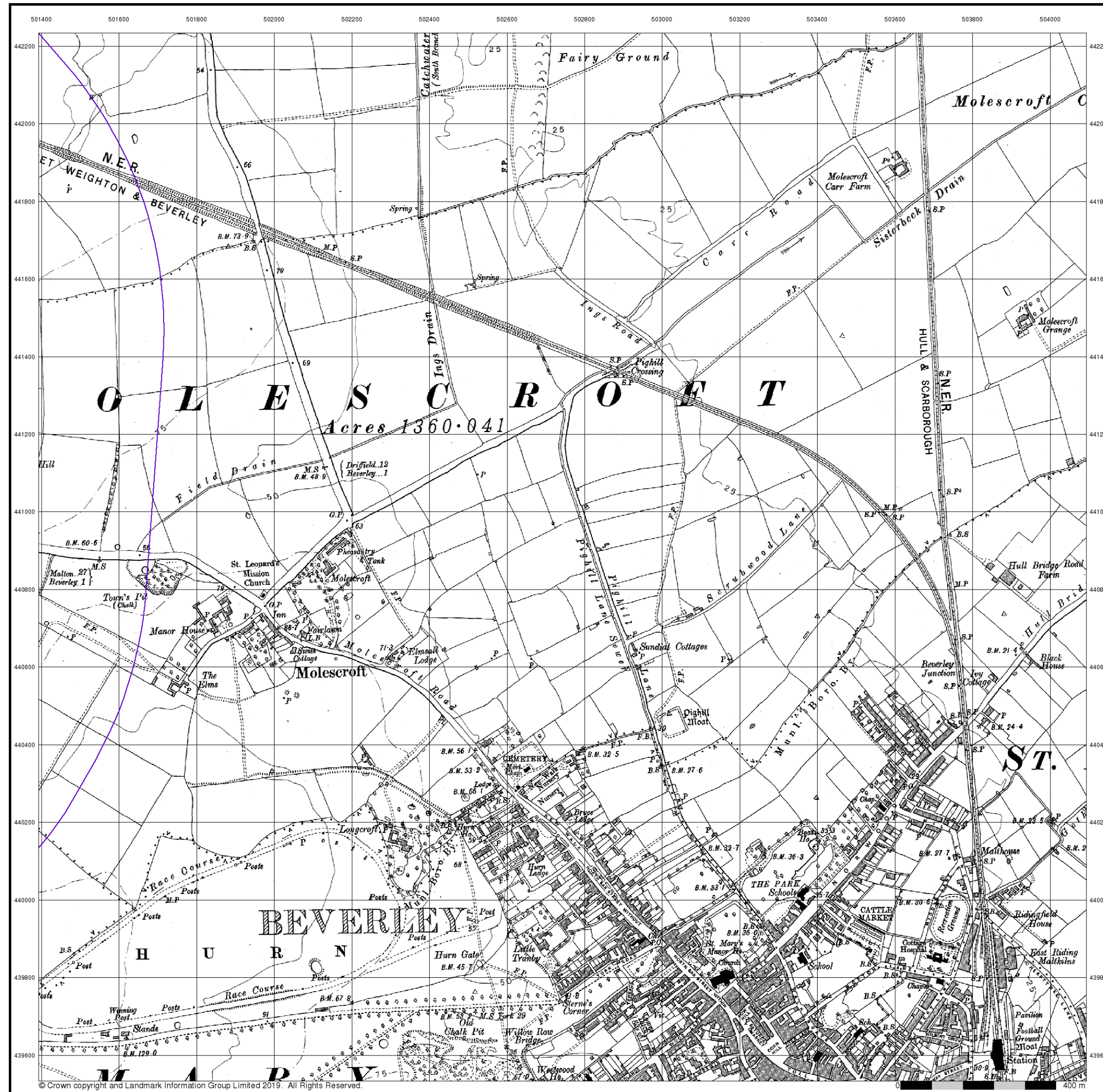

Yorkshire
Published 1911
Source map scale - 1:10,560

The historical maps shown were reproduced from maps predominantly held at the scale adopted for England, Wales and Scotland in the 1840's. In 1854 the 1:2,500 scale was adopted for mapping urban areas; these maps were used to update the 1:10,560 maps. The published date given therefore is often some years later than the surveyed date. Before 1938, all OS maps were based on the Cassini Projection, with independent surveys of a single county or group of counties, giving rise to significant inaccuracies in outlying areas. In the late 1940's, a Provisional Edition was produced, which updated the 1:10,560 mapping from a number of sources. The maps appear unfinished - with all military camps and other strategic sites removed. These maps were initially overprinted with the National Grid. In 1970, the first 1:10,000 maps were produced using the Transverse Mercator Projection. The revision process continued until recently, with new editions appearing every 10 years or so for urban areas.

Map Name(s) and Date(s)

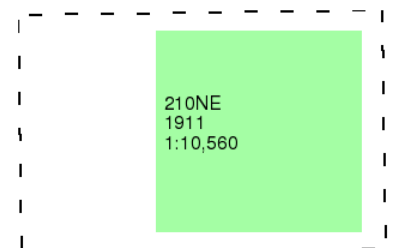

Historical Map - Slice C

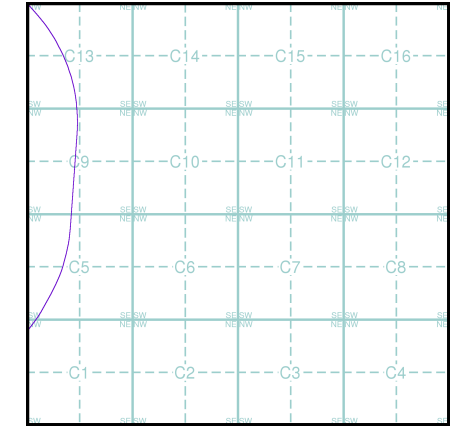

Order Details

Order Number: 201127560_1_1
 Customer Ref: PB8783-103-105
 National Grid Reference: 501530, 441210
 Slice: C
 Site Area (Ha): 53.73
 Search Buffer (m): 1000

Site Details

Hornsea Route

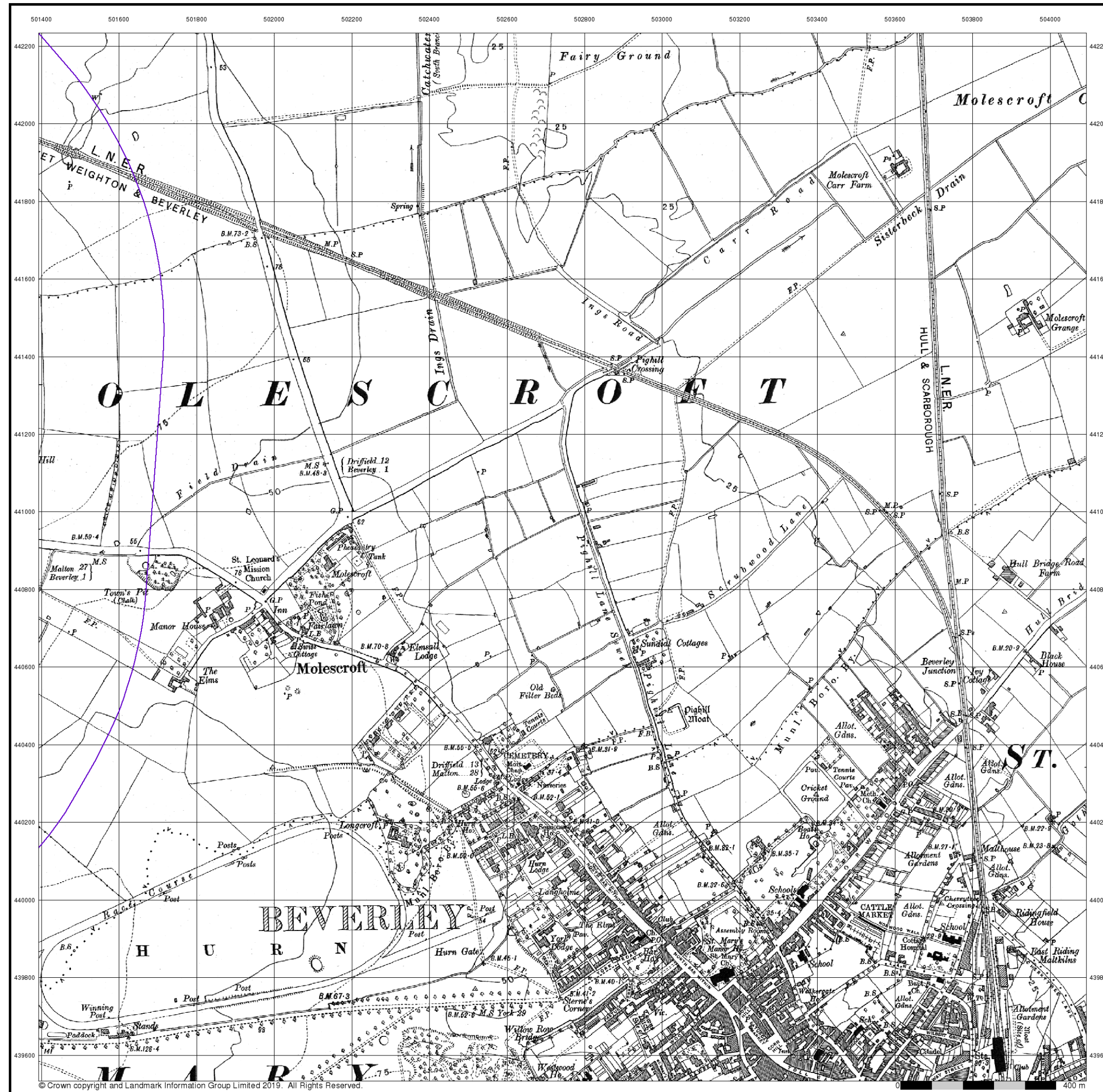

Yorkshire
Published 1928
Source map scale - 1:10,560

The historical maps shown were reproduced from maps predominantly held at the scale adopted for England, Wales and Scotland in the 1840's. In 1854 the 1:2,500 scale was adopted for mapping urban areas; these maps were used to update the 1:10,560 maps. The published date given therefore is often some years later than the surveyed date. Before 1938, all OS maps were based on the Cassini Projection, with independent surveys of a single county or group of counties, giving rise to significant inaccuracies in outlying areas. In the late 1940's, a Provisional Edition was produced, which updated the 1:10,560 mapping from a number of sources. The maps appear unfinished - with all military camps and other strategic sites removed. These maps were initially overprinted with the National Grid. In 1970, the first 1:10,000 maps were produced using the Transverse Mercator Projection. The revision process continued until recently, with new editions appearing every 10 years or so for urban areas.

Map Name(s) and Date(s)

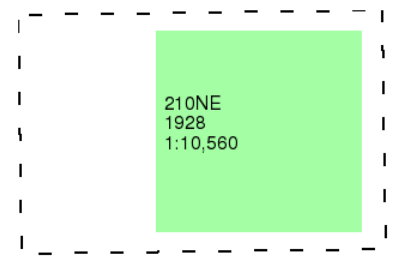

Historical Map - Slice C

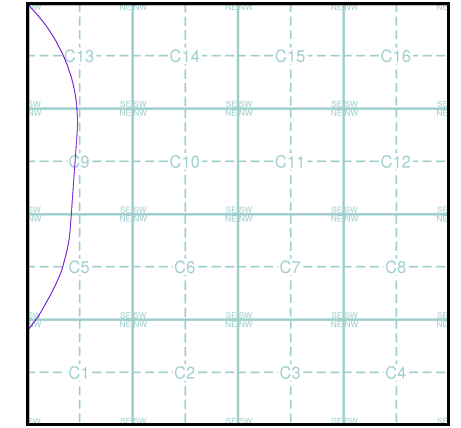

Order Details

Order Number: 201127560_1_1
 Customer Ref: PB8783-103-105
 National Grid Reference: 501530, 441210
 Slice: C
 Site Area (Ha): 53.73
 Search Buffer (m): 1000

Site Details
 Horsea Route

The historical maps shown were reproduced from maps predominantly held at the scale adopted for England, Wales and Scotland in the 1840's. In 1854 the 1:2,500 scale was adopted for mapping urban areas; these maps were used to update the 1:10,560 maps. The published date given therefore is often some years later than the surveyed date. Before 1938, all OS maps were based on the Cassini Projection, with independent surveys of a single county or group of counties, giving rise to significant inaccuracies in outlying areas. In the late 1940's, a Provisional Edition was produced, which updated the 1:10,560 mapping from a number of sources. The maps appear unfinished - with all military camps and other strategic sites removed. These maps were initially overprinted with the National Grid. In 1970, the first 1:10,000 maps were produced using the Transverse Mercator Projection. The revision process continued until recently, with new editions appearing every 10 years or so for urban areas.

Map Name(s) and Date(s)

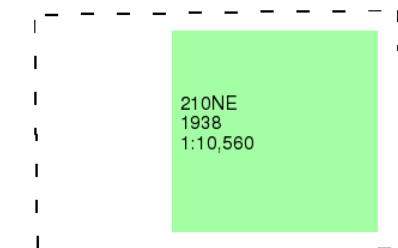

Historical Map - Slice C

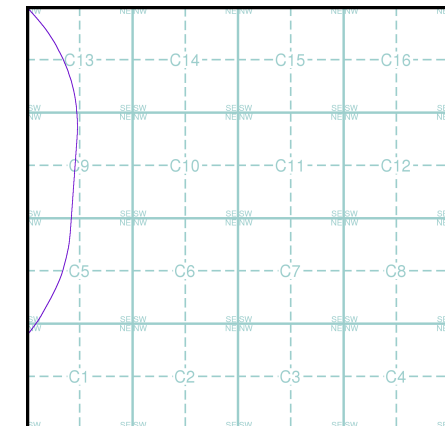

Order Details

Order Number: 201127560_1_1
 Customer Ref: PB8783-103-105
 National Grid Reference: 501530, 441210
 Slice: C
 Site Area (Ha): 53.73
 Search Buffer (m): 1000

Site Details

Hornsea Route

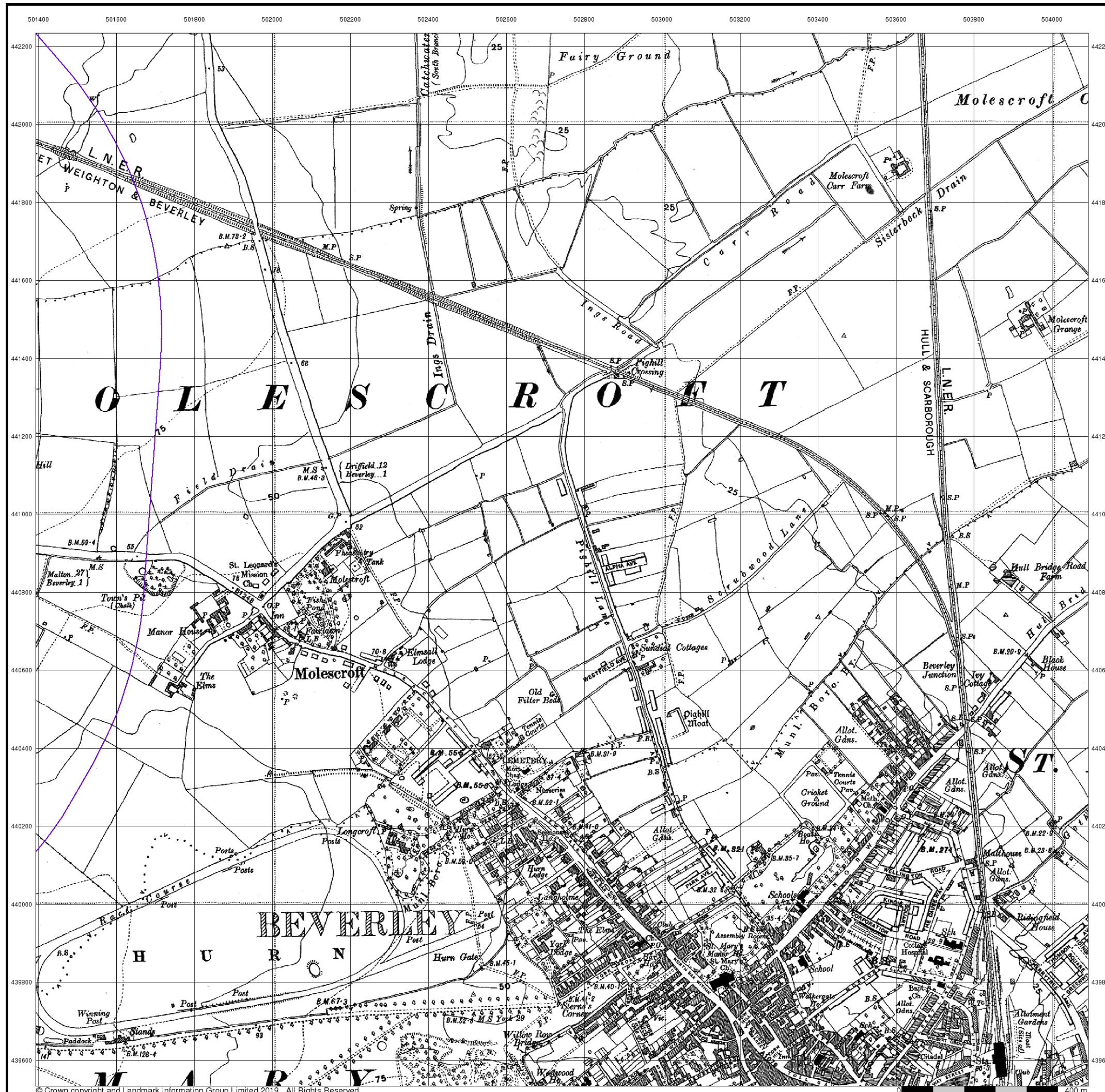

The historical maps shown were reproduced from maps predominantly held at the scale adopted for England, Wales and Scotland in the 1840's. In 1854 the 1:2,500 scale was adopted for mapping urban areas; these maps were used to update the 1:10,560 maps. The published date given therefore is often some years later than the surveyed date. Before 1938, all OS maps were based on the Cassini Projection, with independent surveys of a single county or group of counties, giving rise to significant inaccuracies in outlying areas. In the late 1940's, a Provisional Edition was produced, which updated the 1:10,560 mapping from a number of sources. The maps appear unfinished - with all military camps and other strategic sites removed. These maps were initially overprinted with the National Grid. In 1970, the first 1:10,000 maps were produced using the Transverse Mercator Projection. The revision process continued until recently, with new editions appearing every 10 years or so for urban areas.

Map Name(s) and Date(s)

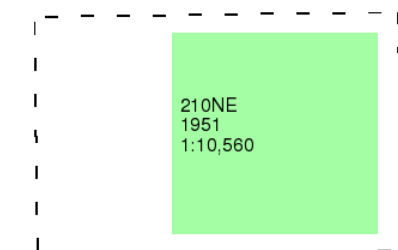

Historical Map - Slice C

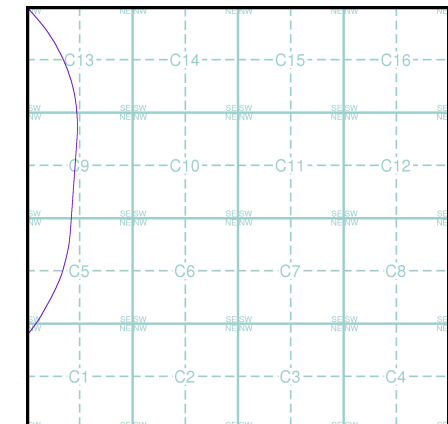

Order Details

Order Number: 201127560_1_1
 Customer Ref: PB8783-103-105
 National Grid Reference: 501530, 441210
 Slice: C
 Site Area (Ha): 53.73
 Search Buffer (m): 1000

Site Details

Hornsea Route



Ordnance Survey Plan

Published 1956

Source map scale - 1:10,000

The historical maps shown were reproduced from maps predominantly held at the scale adopted for England, Wales and Scotland in the 1840's. In 1854 the 1:2,500 scale was adopted for mapping urban areas; these maps were used to update the 1:10,560 maps. The published date given therefore is often some years later than the surveyed date. Before 1938, all OS maps were based on the Cassini Projection, with independent surveys of a single county or group of counties, giving rise to significant inaccuracies in outlying areas. In the late 1940's, a Provisional Edition was produced, which updated the 1:10,560 mapping from a number of sources. The maps appear unfinished - with all military camps and other strategic sites removed. These maps were initially overprinted with the National Grid. In 1970, the first 1:10,000 maps were produced using the Transverse Mercator Projection. The revision process continued until recently, with new editions appearing every 10 years or so for urban areas.

Map Name(s) and Date(s)

TA04SW	1956
1:10,560	
TA03NW	1956
1:10,560	

Historical Map - Slice C

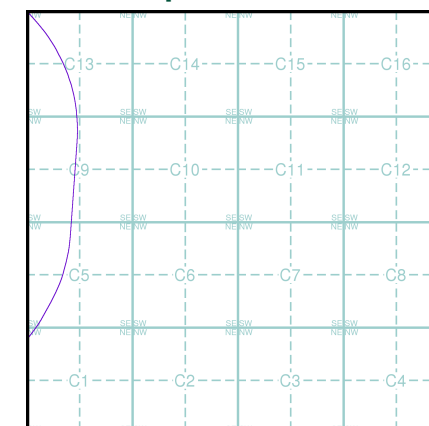

Order Details

Order Number: 201127560_1_1
 Customer Ref: PB8783-103-105
 National Grid Reference: 501530, 441210
 Slice: C
 Site Area (Ha): 53.73
 Search Buffer (m): 1000

Site Details

Hornsea Route



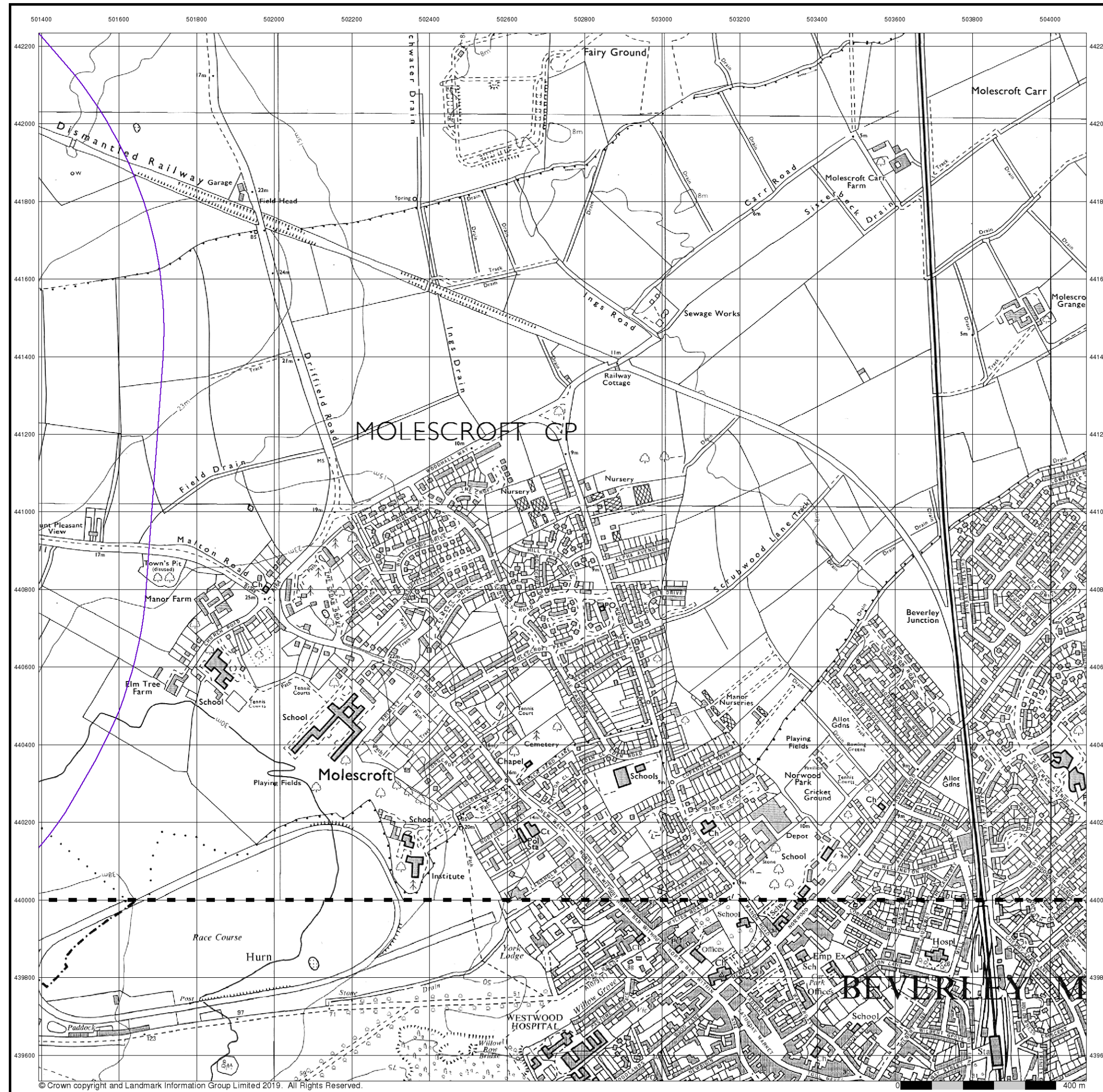

Ordnance Survey Plan

Published 1970 - 1975

Source map scale - 1:10,000

The historical maps shown were reproduced from maps predominantly held at the scale adopted for England, Wales and Scotland in the 1840's. In 1854 the 1:2,500 scale was adopted for mapping urban areas; these maps were used to update the 1:10,560 maps. The published date given therefore is often some years later than the surveyed date. Before 1938, all OS maps were based on the Cassini Projection, with independent surveys of a single county or group of counties, giving rise to significant inaccuracies in outlying areas. In the late 1940's, a Provisional Edition was produced, which updated the 1:10,560 mapping from a number of sources. The maps appear unfinished - with all military camps and other strategic sites removed. These maps were initially overprinted with the National Grid. In 1970, the first 1:10,000 maps were produced using the Transverse Mercator Projection. The revision process continued until recently, with new editions appearing every 10 years or so for urban areas.

Map Name(s) and Date(s)

TA04SW	1975	1:10,000
TA03NW	1970	1:10,560

Historical Map - Slice C

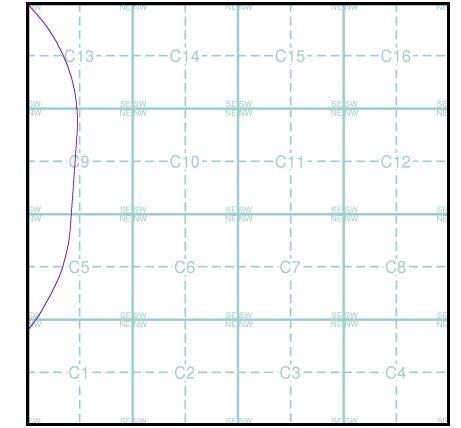

Order Details

Order Number: 201127560_1_1
 Customer Ref: PB8783-103-105
 National Grid Reference: 501530, 441210
 Slice: C
 Site Area (Ha): 53.73
 Search Buffer (m): 1000

Site Details

Hornsea Route

Ordnance Survey Plan

Published 1982

Source map scale - 1:10,000

The historical maps shown were reproduced from maps predominantly held at the scale adopted for England, Wales and Scotland in the 1840's. In 1854 the 1:2,500 scale was adopted for mapping urban areas; these maps were used to update the 1:10,560 maps. The published date given therefore is often some years later than the surveyed date. Before 1938, all OS maps were based on the Cassini Projection, with independent surveys of a single county or group of counties, giving rise to significant inaccuracies in outlying areas. In the late 1940's, a Provisional Edition was produced, which updated the 1:10,560 mapping from a number of sources. The maps appear unfinished - with all military camps and other strategic sites removed. These maps were initially overprinted with the National Grid. In 1970, the first 1:10,000 maps were produced using the Transverse Mercator Projection. The revision process continued until recently, with new editions appearing every 10 years or so for urban areas.

Map Name(s) and Date(s)

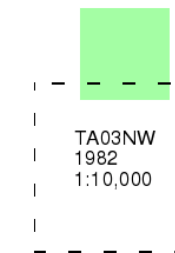

Historical Map - Slice C

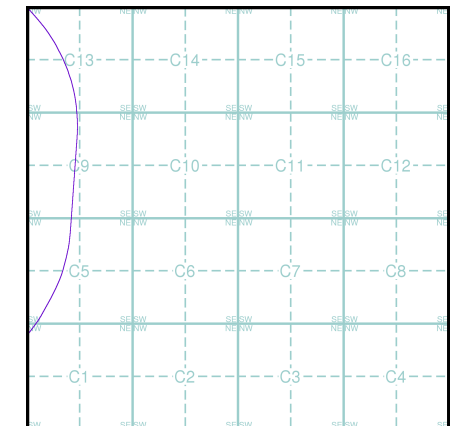

Order Details

Order Number: 201127560_1_1
 Customer Ref: PB8783-103-105
 National Grid Reference: 501530, 441210
 Slice: C
 Site Area (Ha): 53.73
 Search Buffer (m): 1000

Site Details

Hornsea Route

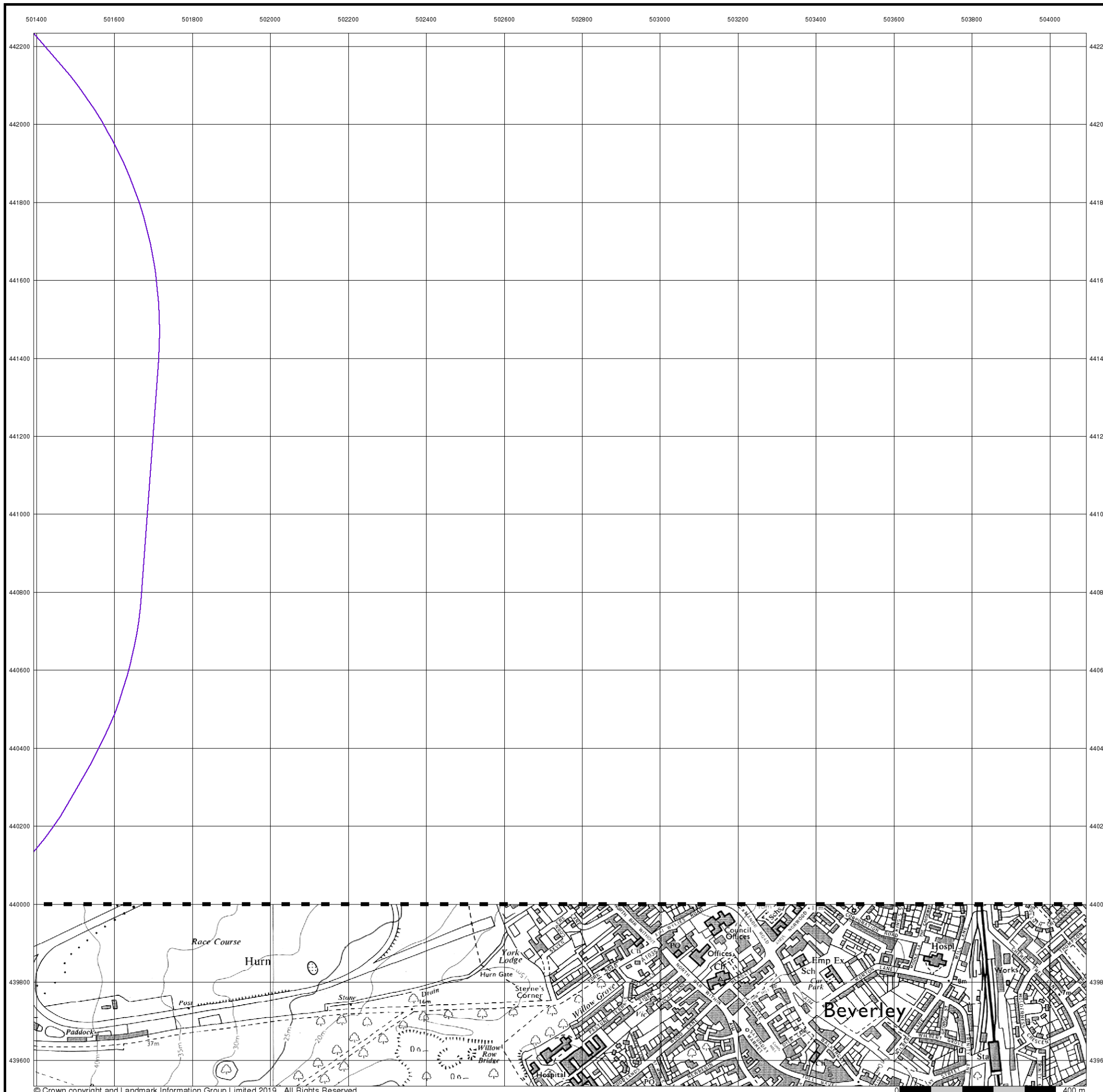

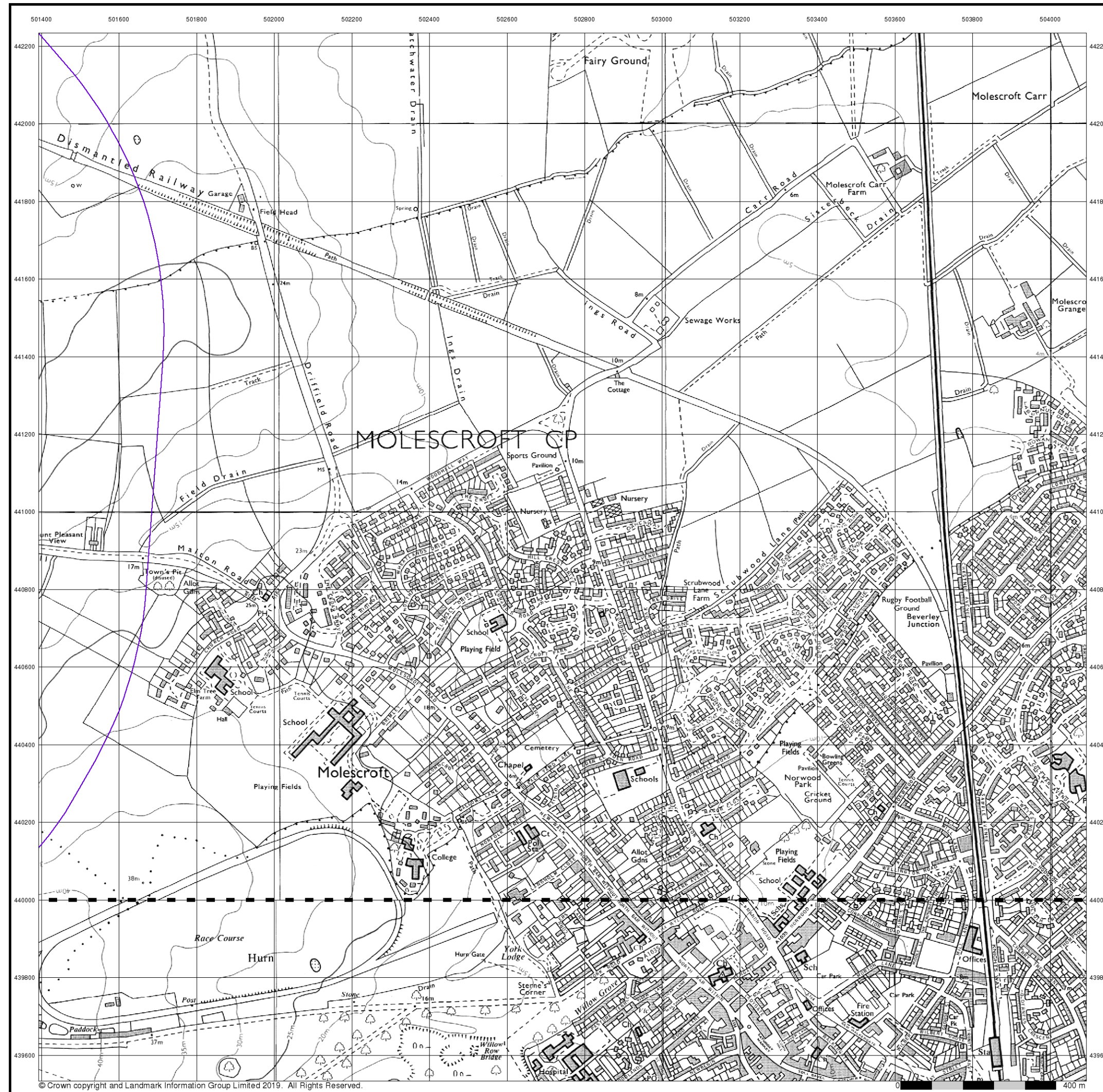

Ordnance Survey Plan
Published 1993 - 1994
Source map scale - 1:10,000

The historical maps shown were reproduced from maps predominantly held at the scale adopted for England, Wales and Scotland in the 1840's. In 1854 the 1:2,500 scale was adopted for mapping urban areas; these maps were used to update the 1:10,560 maps. The published date given therefore is often some years later than the surveyed date. Before 1938, all OS maps were based on the Cassini Projection, with independent surveys of a single county or group of counties, giving rise to significant inaccuracies in outlying areas. In the late 1940's, a Provisional Edition was produced, which updated the 1:10,560 mapping from a number of sources. The maps appear unfinished - with all military camps and other strategic sites removed. These maps were initially overprinted with the National Grid. In 1970, the first 1:10,000 maps were produced using the Transverse Mercator Projection. The revision process continued until recently, with new editions appearing every 10 years or so for urban areas.

Map Name(s) and Date(s)

- TA04SW | 1994 | 1:10,000
- TA03NW | 1993 | 1:10,000

Historical Map - Slice C

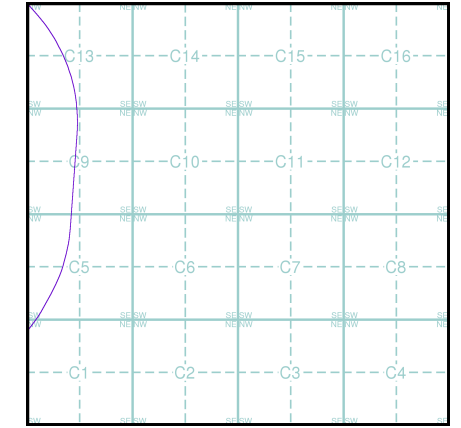

Order Details

Order Number: 201127560_1_1
 Customer Ref: PB8783-103-105
 National Grid Reference: 501530, 441210
 Slice: C
 Site Area (Ha): 53.73
 Search Buffer (m): 1000

Site Details

Hornsea Route

10k Raster Mapping

Published 1999

Source map scale - 1:10,000

The historical maps shown were produced from the Ordnance Survey's 1:10,000 colour raster mapping. These maps are derived from Landplan which replaced the old 1:10,000 maps originally published in 1970. The data is highly detailed showing buildings, fences and field boundaries as well as all roads, tracks and paths. Road names are also included together with the relevant road number and classification. Boundary information depiction includes county, unitary authority, district, civil parish and constituency.

Map Name(s) and Date(s)

TA04SW	1999	1:10,000
TA03NW	1999	1:10,000

Historical Map - Slice C

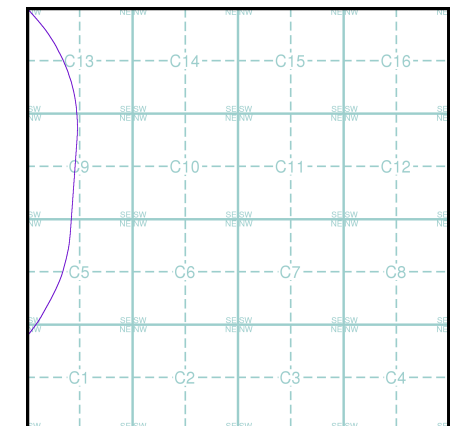

Order Details

Order Number: 201127560_1_1
 Customer Ref: PB8783-103-105
 National Grid Reference: 501530, 441210
 Slice: C
 Site Area (Ha): 53.73
 Search Buffer (m): 1000

Site Details

Hornsea Route



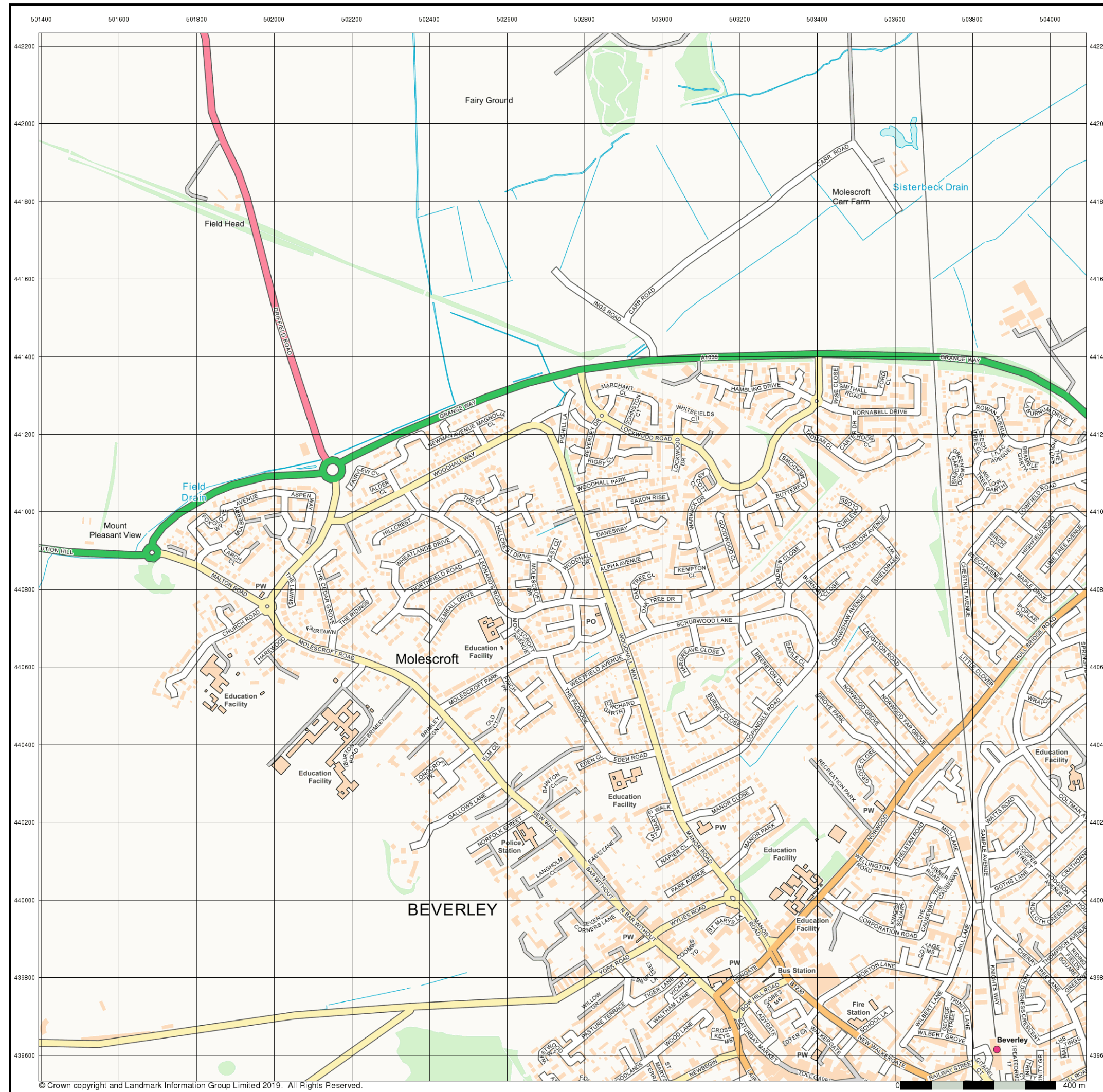

Street View

Published 2019

Source map scale - 1:10,000

Street View is a street-level map for the whole of Great Britain produced by the Ordnance Survey. These maps are provided at a nominal scale of 1:10,000

Map Name(s) and Date(s)

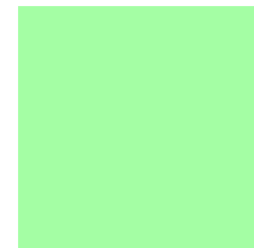

Street View Map - Slice C

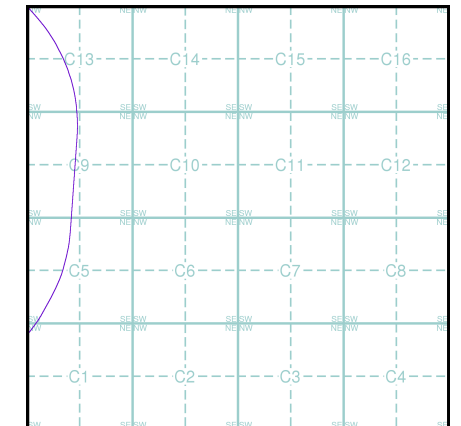

Order Details

Order Number: 201127560_1_1
 Customer Ref: PB8783-103-105
 National Grid Reference: 501530, 441210
 Slice: C
 Site Area (Ha): 53.73
 Search Buffer (m): 1000

Site Details

Hornsea Route

General

- ✱ Specified Site
- ✱ Specified Buffer(s)
- ✱ Bearing Reference Point
- Map ID
- Several of Type at Location

Agency and Hydrological

- Contaminated Land Register Entry or Notice (Location)
- Contaminated Land Register Entry or Notice
- ◆ Discharge Consent
- ▲ Enforcement or Prohibition Notice
- ▲ Integrated Pollution Control
- Integrated Pollution Prevention Control
- Local Authority Integrated Pollution Prevention and Control
- ▲ Local Authority Pollution Prevention and Control
- ▲ Local Authority Pollution Prevention and Control Enforcement
- Pollution Incident to Controlled Waters
- ▲ Prosecution Relating to Authorised Processes
- ◆ Prosecution Relating to Controlled Waters
- ▲ Registered Radioactive Substance
- + River Network or Water Feature
- + River Quality Sampling Point
- Substantiated Pollution Incident Register
- ◆ Water Abstraction
- ◆ Water Industry Act Referral

Waste

- ▼ BGS Recorded Landfill Site (Location)
- BGS Recorded Landfill Site
- EA Historic Landfill (Buffered Point)
- EA Historic Landfill (Polygon)
- ▲ Integrated Pollution Control Registered Waste Site
- Licensed Waste Management Facility (Landfill Boundary)
- Licensed Waste Management Facility (Location)
- Local Authority Recorded Landfill Site (Location)
- Local Authority Recorded Landfill Site
- Registered Landfill Site
- ▲ Registered Landfill Site (Location)
- Registered Landfill Site (Point Buffered to 100m)
- Registered Landfill Site (Point Buffered to 250m)
- Registered Waste Transfer Site (Location)
- Registered Waste Transfer Site
- Registered Waste Treatment or Disposal Site (Location)
- Registered Waste Treatment or Disposal Site

Geological

- ▼ BGS Recorded Mineral Site

Industrial Land Use

- ✱ Contemporary Trade Directory Entry
- ✱ Fuel Station Entry
- ✱ COMAH Site
- ✱ Explosive Site
- ✱ NIHS Site
- ✱ Planning Hazardous Substance Consent
- ✱ Planning Hazardous Substance Enforcement

Site Sensitivity Map - Slice C

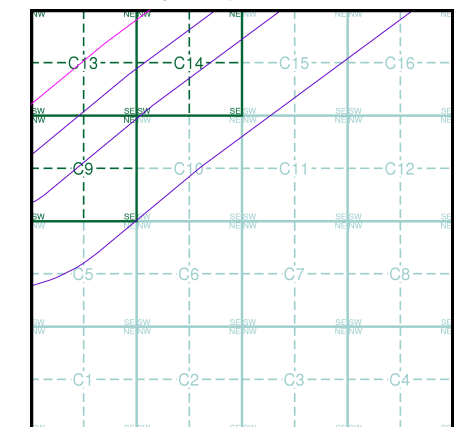

Order Details

Order Number: 201127462_1_1
 Customer Ref: PB8783-103-105
 National Grid Reference: 514690, 456000
 Slice: C
 Site Area (Ha): 2345.09
 Search Buffer (m): 1000



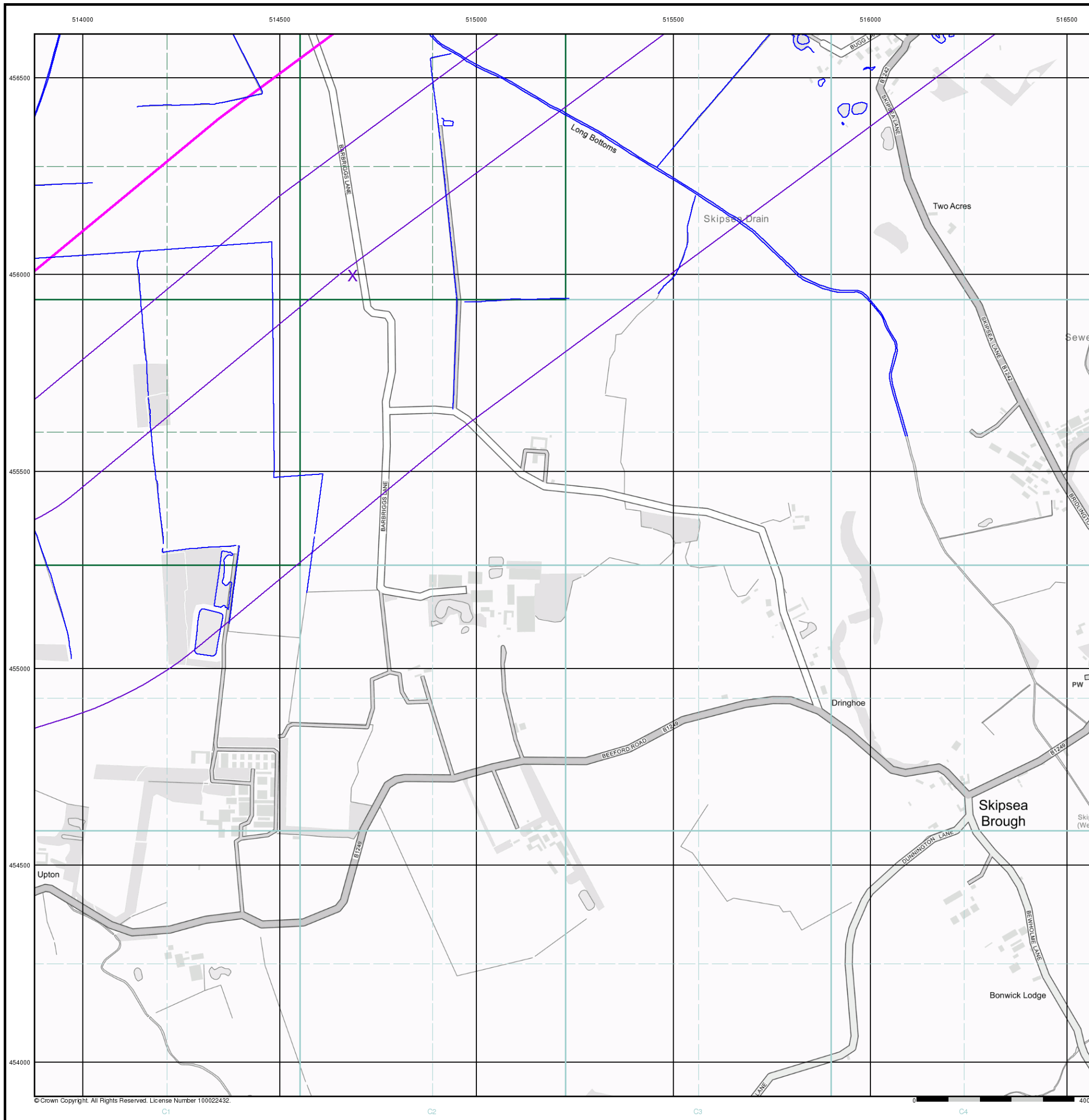

Site Details

Hornsea Route







Industrial Land Use Map

General

-  Specified Site
-  Specified Buffer(s)
-  Bearing Reference Point
-  Slice
-  Map ID

Industrial Land Use

-  Contemporary Trade Directory Entry
-  Fuel Station Entry
-  Gas Pipeline
-  Underground Electrical Cables

Industrial Land Use Map - Slice C

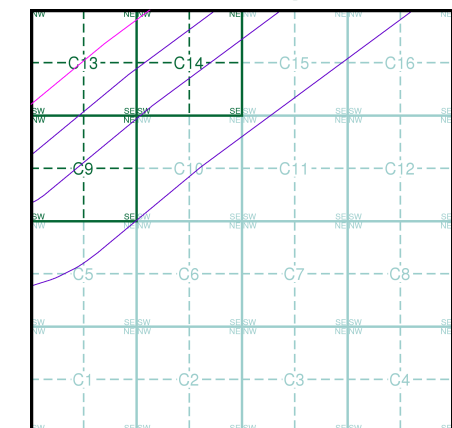

Order Details



Order Number: 201127462_1_1
 Customer Ref: PB8783-103-105
 National Grid Reference: 514690, 456000
 Slice: C
 Site Area (Ha): 2345.09
 Search Buffer (m): 1000

Site Details

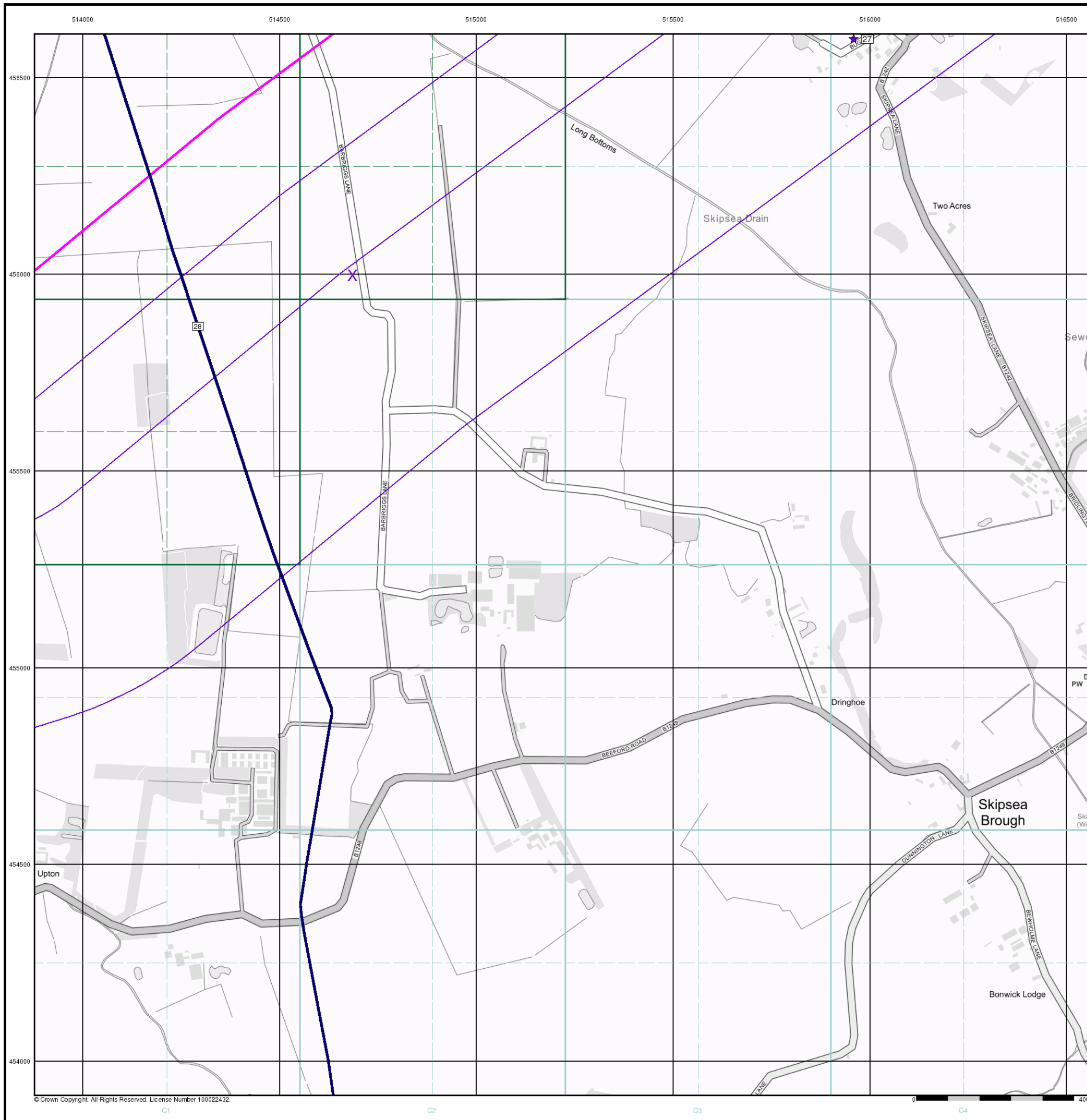



Hornsea Route



General

-  Specified Site
-  Specified Buffer(s)
-  Bearing Reference Point

Agency and Hydrological (Flood)

-  Extreme Flooding from Rivers or Sea without Defences (Zone 2)
-  Flooding from Rivers or Sea without Defences (Zone 3)
-  Area Benefiting from Flood Defence
-  Flood Water Storage Areas
-  Flood Defence

Flood Map - Slice C

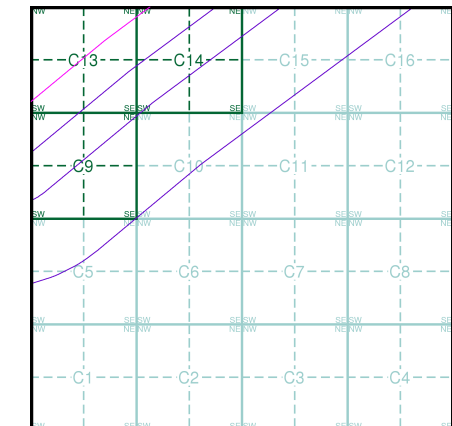

Order Details

Order Number: 201127462_1_1
 Customer Ref: PB8783-103-105
 National Grid Reference: 514690, 456000
 Slice: C
 Site Area (Ha): 2345.09
 Search Buffer (m): 1000

Site Details

Hornsea Route



© Crown Copyright. All Rights Reserved. License Number 100022432.

General

- Specified Site
- Specified Buffer(s)
- Bearing Reference Point
- Map ID
- Several of Type at Location

Agency and Hydrological (Boreholes)

- BGS Borehole Depth 0 - 10m
- BGS Borehole Depth 10 - 30m
- BGS Borehole Depth 30m +
- Confidential
- Other

For Borehole information please refer to the Borehole .csv file which accompanied this slice.

A copy of the BGS Borehole Ordering Form is available to download from the Support section of www.envirocheck.co.uk.

Borehole Map - Slice C

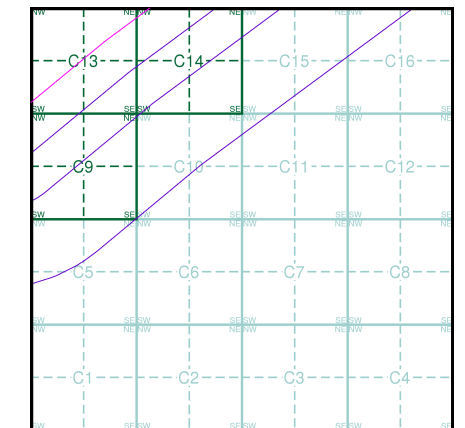

Order Details

Order Number: 201127462_1_1
 Customer Ref: PB8783-103-105
 National Grid Reference: 514690, 456000
 Slice: C
 Site Area (Ha): 2345.09
 Search Buffer (m): 1000

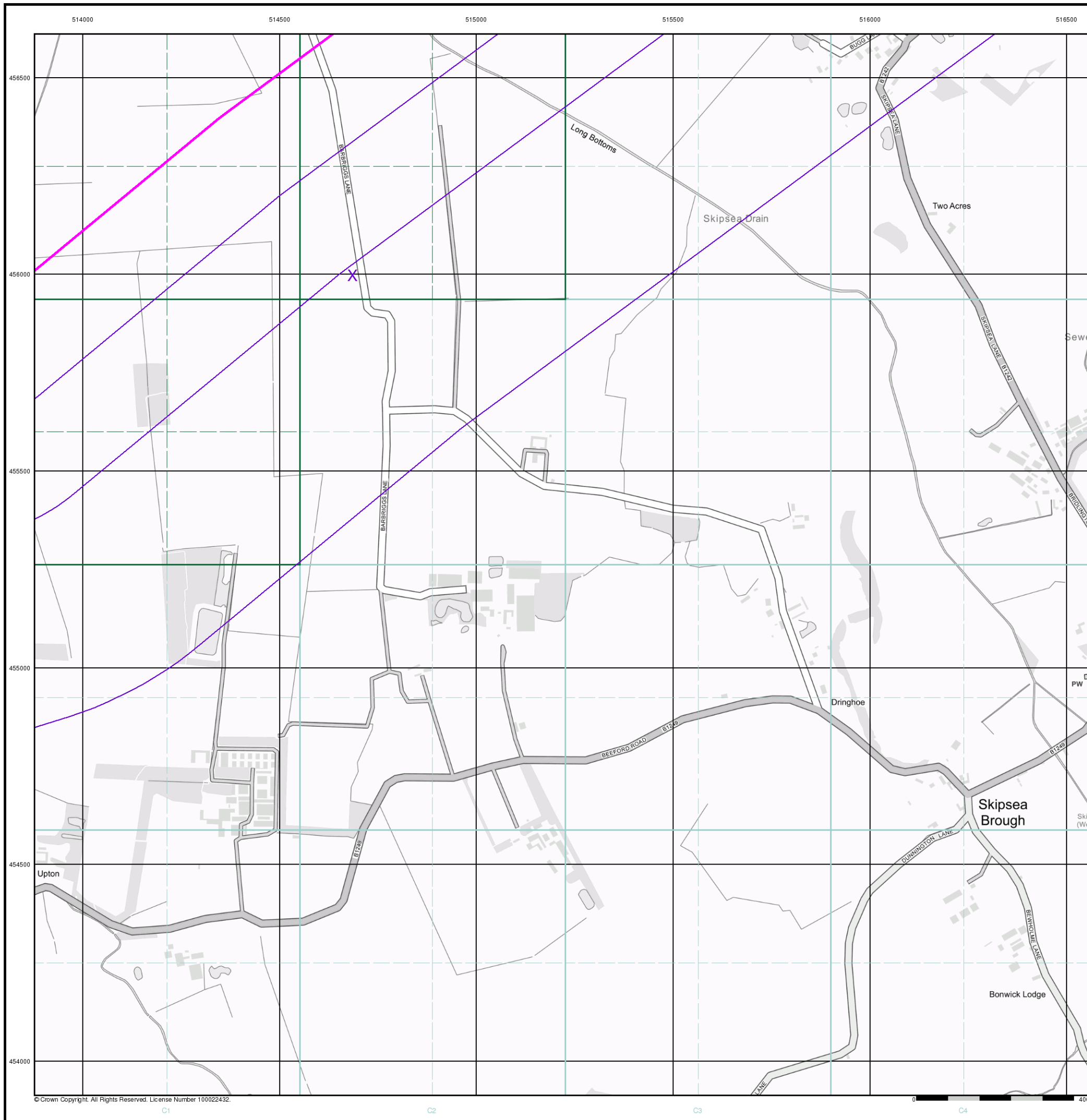

Site Details

Hornsea Route



© Crown Copyright. All Rights Reserved. License Number 100022432.

General

-  Specified Site
-  Specified Buffer(s)
-  Bearing Reference Point

OS Water Network Data

- | | |
|--|---|
|  Canal |  Drain |
|  Reservoir |  Other |
|  Foreshore |  Lake |
|  Marsh |  Transfer |
|  Tidal River |  Lock Or Flight Of Locks |
|  Inland River |  Sea |

OS Water Network Map - Slice C

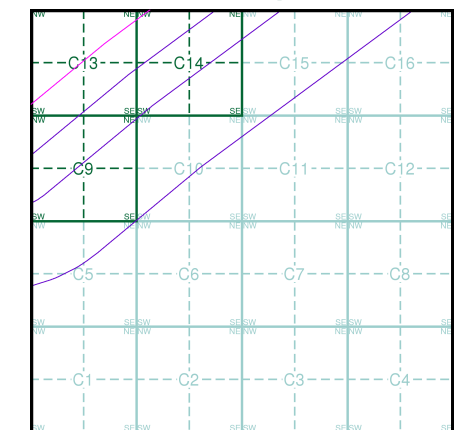

Order Details

Order Number: 201127462_1_1
 Customer Ref: PB8783-103-105
 National Grid Reference: 514690, 456000
 Slice: C
 Site Area (Ha): 2345.09
 Search Buffer (m): 1000

Site Details

Hornsea Route

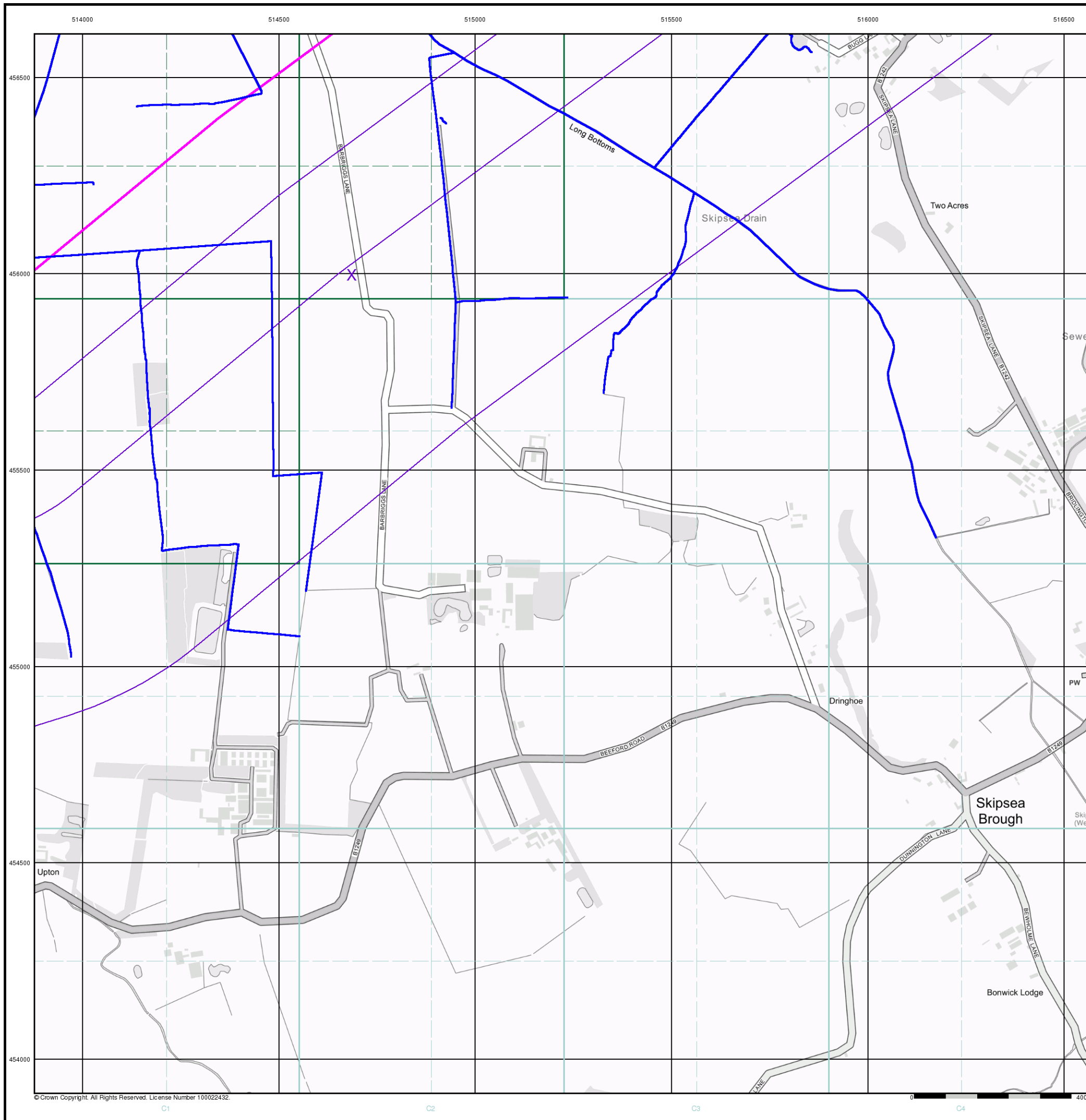

© Crown Copyright. All Rights Reserved. License Number 100022432.

General

- Specified Site
- Specified Buffer(s)
- Bearing Reference Point
- Map ID
- Several of Type at Location

Agency and Hydrological

- Contaminated Land Register Entry or Notice (Location)
- Contaminated Land Register Entry or Notice
- Discharge Consent
- Enforcement or Prohibition Notice
- Integrated Pollution Control
- Integrated Pollution Prevention Control
- Local Authority Integrated Pollution Prevention and Control
- Local Authority Pollution Prevention and Control
- Local Authority Pollution Prevention and Control Enforcement
- Pollution Incident to Controlled Waters
- Prosecution Relating to Authorised Processes
- Prosecution Relating to Controlled Waters
- Registered Radioactive Substance
- River Network or Water Feature
- River Quality Sampling Point
- Substantiated Pollution Incident Register
- Water Abstraction
- Water Industry Act Referral

Waste

- BGS Recorded Landfill Site (Location)
- BGS Recorded Landfill Site
- EA Historic Landfill (Buffered Point)
- EA Historic Landfill (Polygon)
- Integrated Pollution Control Registered Waste Site
- Licensed Waste Management Facility (Landfill Boundary)
- Licensed Waste Management Facility (Location)
- Local Authority Recorded Landfill Site (Location)
- Local Authority Recorded Landfill Site
- Registered Landfill Site
- Registered Landfill Site (Location)
- Registered Landfill Site (Point Buffered to 100m)
- Registered Landfill Site (Point Buffered to 250m)
- Registered Waste Transfer Site (Location)
- Registered Waste Transfer Site
- Registered Waste Treatment or Disposal Site (Location)
- Registered Waste Treatment or Disposal Site

Geological

- BGS Recorded Mineral Site

Industrial Land Use

- Contemporary Trade Directory Entry
- Fuel Station Entry

Hazardous Substances

- COMAH Site
- Explosive Site
- NIHHS Site
- Planning Hazardous Substance Consent
- Planning Hazardous Substance Enforcement

Site Sensitivity Map - Slice C

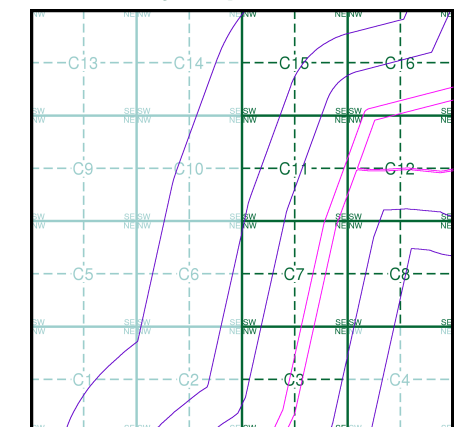

Order Details

Order Number: 201127465_1_1
 Customer Ref: PB8783-103-105
 National Grid Reference: 506560, 453280
 Slice: C
 Site Area (Ha): 72.
 Search Buffer (m): 1000

Site Details



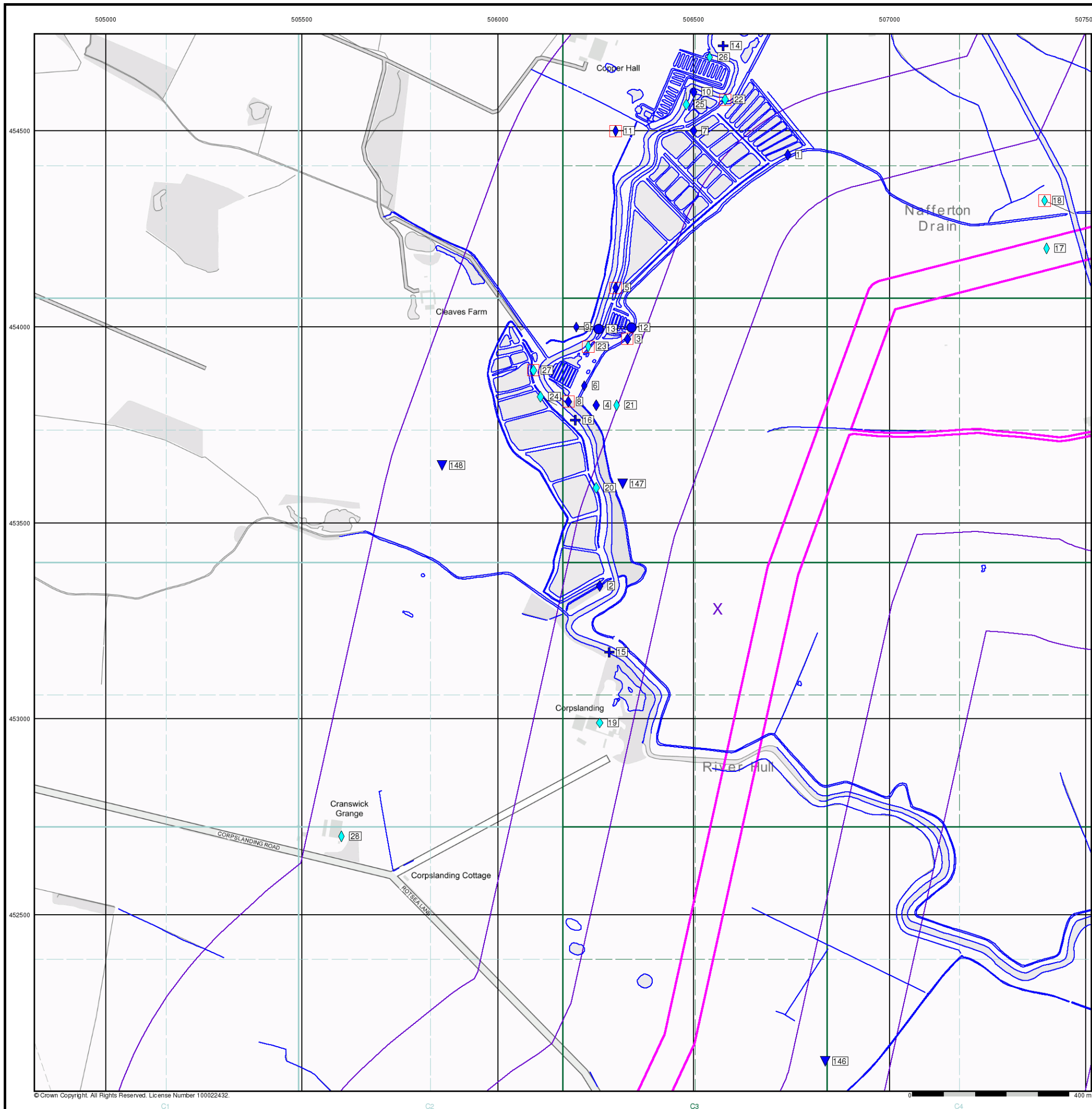

Hornsea Route







© Crown Copyright. All Rights Reserved. License Number 100022432.

Industrial Land Use Map

General

-  Specified Site
-  Specified Buffer(s)
-  Bearing Reference Point
-  Slice
-  Map ID

Industrial Land Use

-  Contemporary Trade Directory Entry
-  Fuel Station Entry
-  Gas Pipeline
-  Underground Electrical Cables

Industrial Land Use Map - Slice C

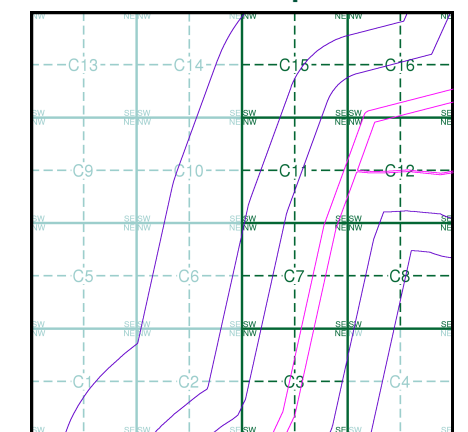

Order Details



Order Number: 201127465_1_1
 Customer Ref: PB8783-103-105
 National Grid Reference: 506560, 453280
 Slice: C
 Site Area (Ha): 72.
 Search Buffer (m): 1000

Site Details

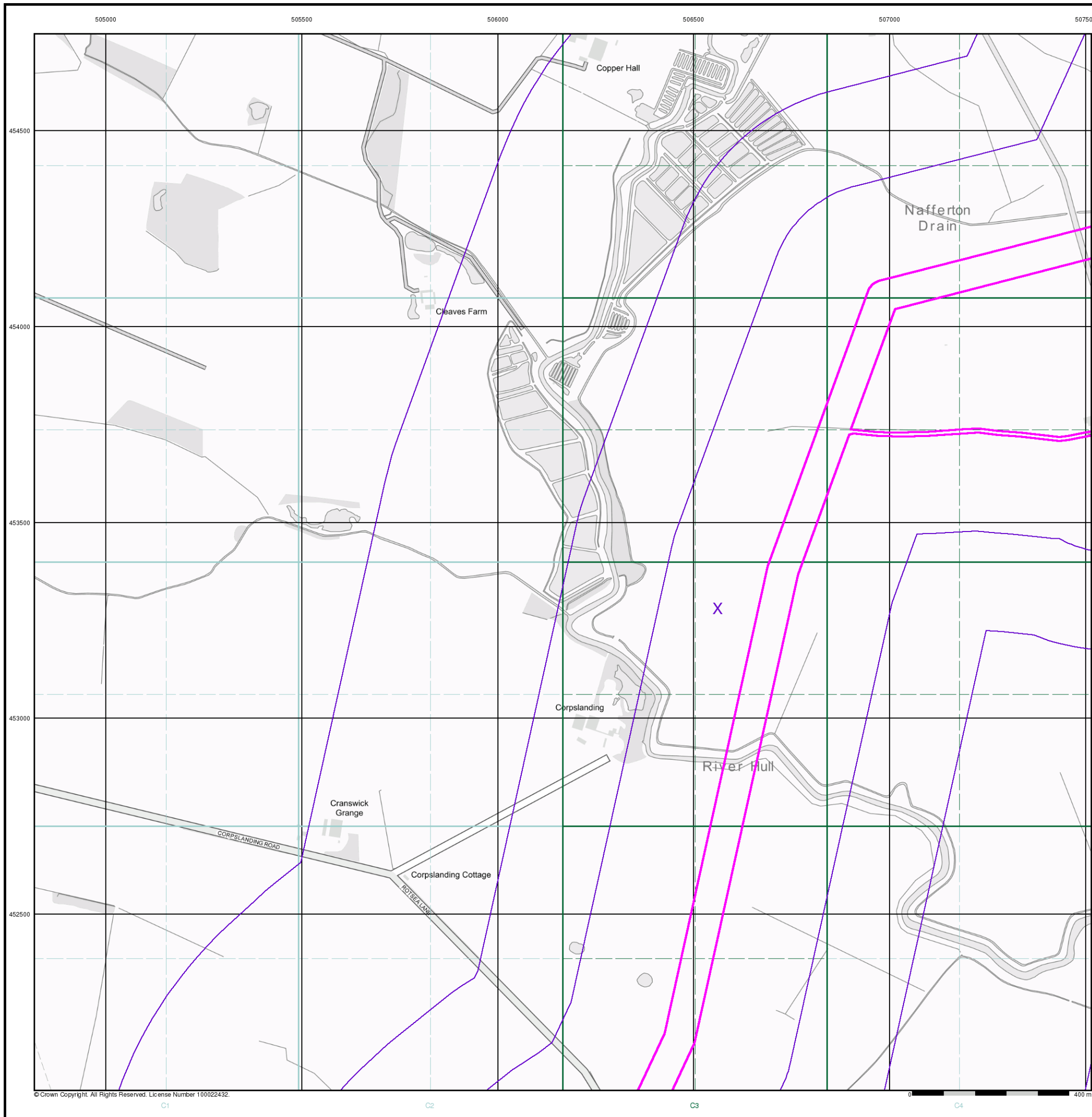



Hornsea Route



General

-  Specified Site
-  Specified Buffer(s)
-  Bearing Reference Point

Agency and Hydrological (Flood)

-  Extreme Flooding from Rivers or Sea without Defences (Zone 2)
-  Flooding from Rivers or Sea without Defences (Zone 3)
-  Area Benefiting from Flood Defence
-  Flood Water Storage Areas
-  Flood Defence

Flood Map - Slice C

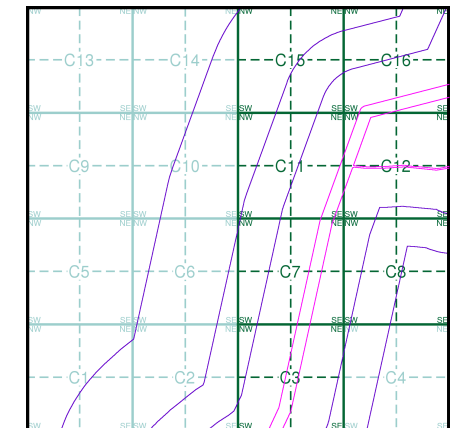

Order Details

Order Number: 201127465_1_1
 Customer Ref: PB8783-103-105
 National Grid Reference: 506560, 453280
 Slice: C
 Site Area (Ha): 72.
 Search Buffer (m): 1000

Site Details

Hornsea Route

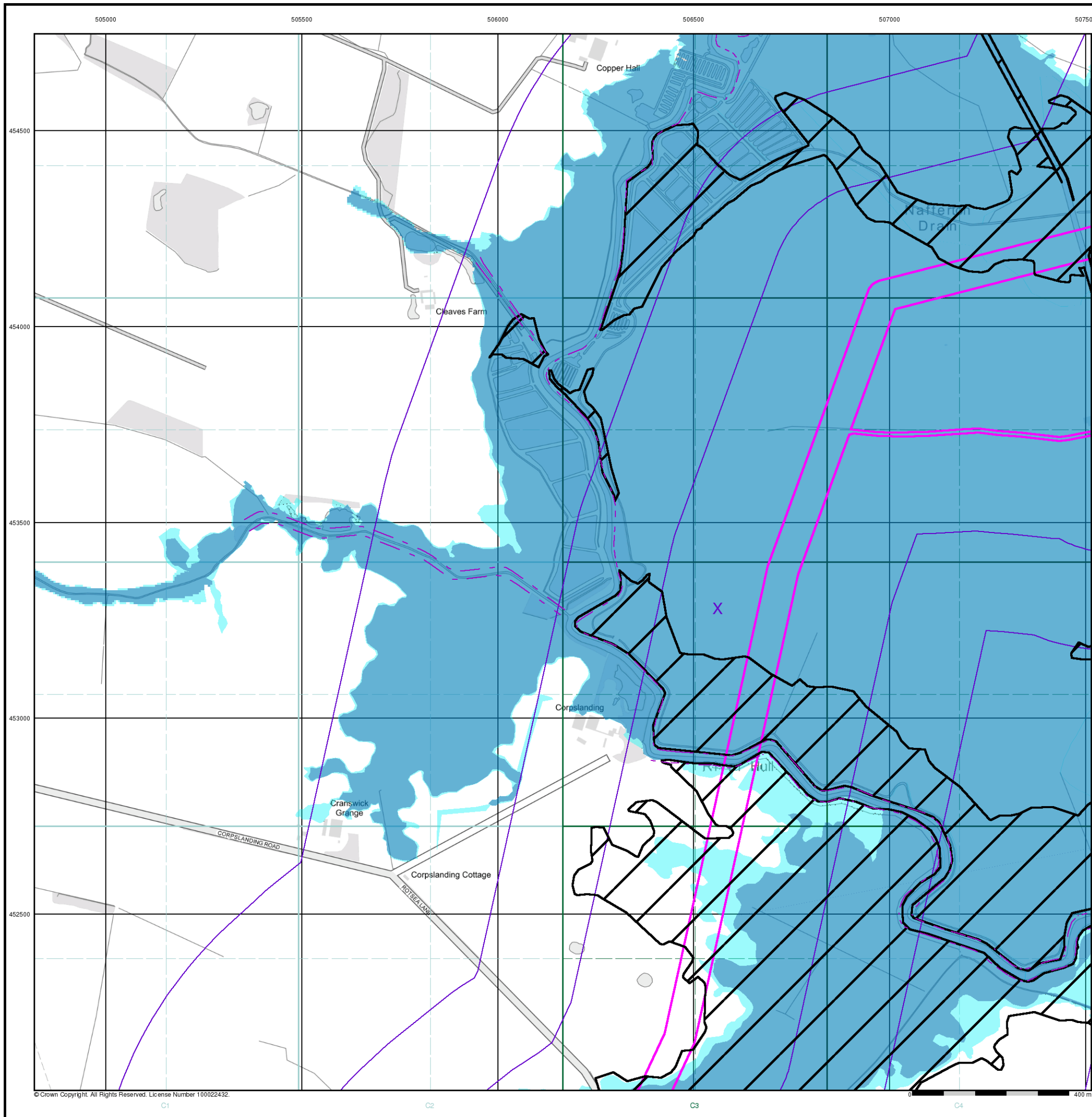

General

- Specified Site
- Specified Buffer(s)
- X Bearing Reference Point
- Map ID
- Several of Type at Location

Agency and Hydrological (Boreholes)

- BGS Borehole Depth 0 - 10m
- BGS Borehole Depth 10 - 30m
- BGS Borehole Depth 30m +
- Confidential
- Other

For Borehole information please refer to the Borehole .csv file which accompanied this slice.

A copy of the BGS Borehole Ordering Form is available to download from the Support section of www.envirocheck.co.uk.

Borehole Map - Slice C

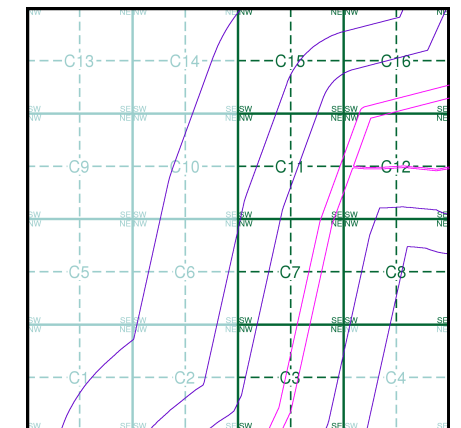

Order Details



Order Number: 201127465_1_1
 Customer Ref: PB8783-103-105
 National Grid Reference: 506560, 453280
 Slice: C
 Site Area (Ha): 72.
 Search Buffer (m): 1000

Site Details

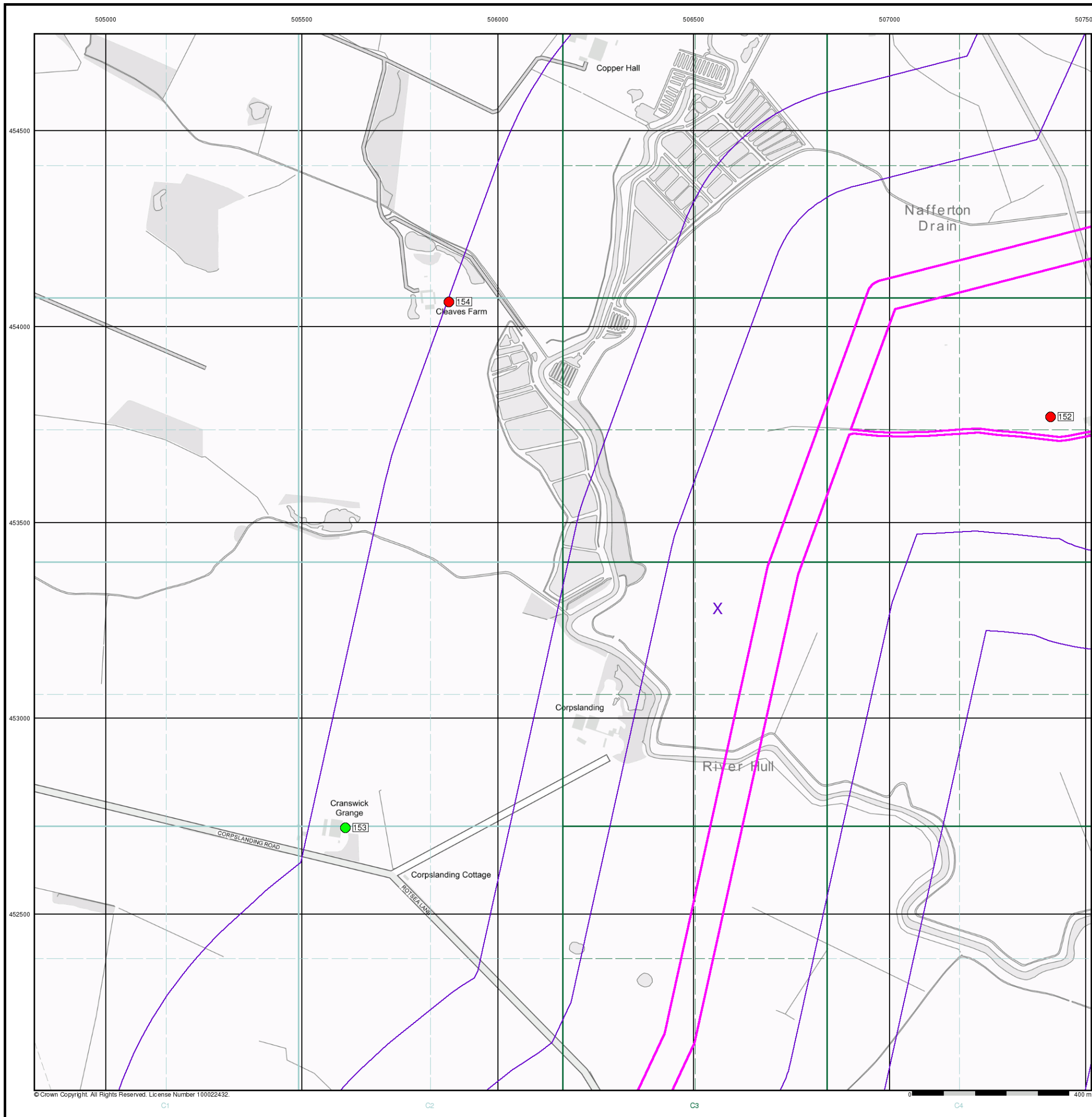
Hornsea Route



General

-  Specified Site
-  Specified Buffer(s)
-  Bearing Reference Point

OS Water Network Data

- | | |
|--|---|
|  Canal |  Drain |
|  Reservoir |  Other |
|  Foreshore |  Lake |
|  Marsh |  Transfer |
|  Tidal River |  Lock Or Flight Of Locks |
|  Inland River |  Sea |

OS Water Network Map - Slice C

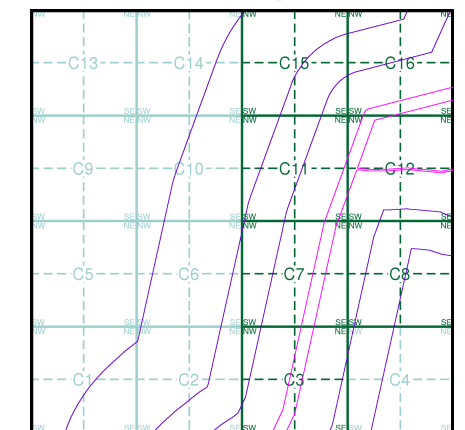

Order Details

Order Number: 201127465_1_1
 Customer Ref: PB8783-103-105
 National Grid Reference: 506560, 453280
 Slice: C
 Site Area (Ha): 72.
 Search Buffer (m): 1000

Site Details

Hornsea Route

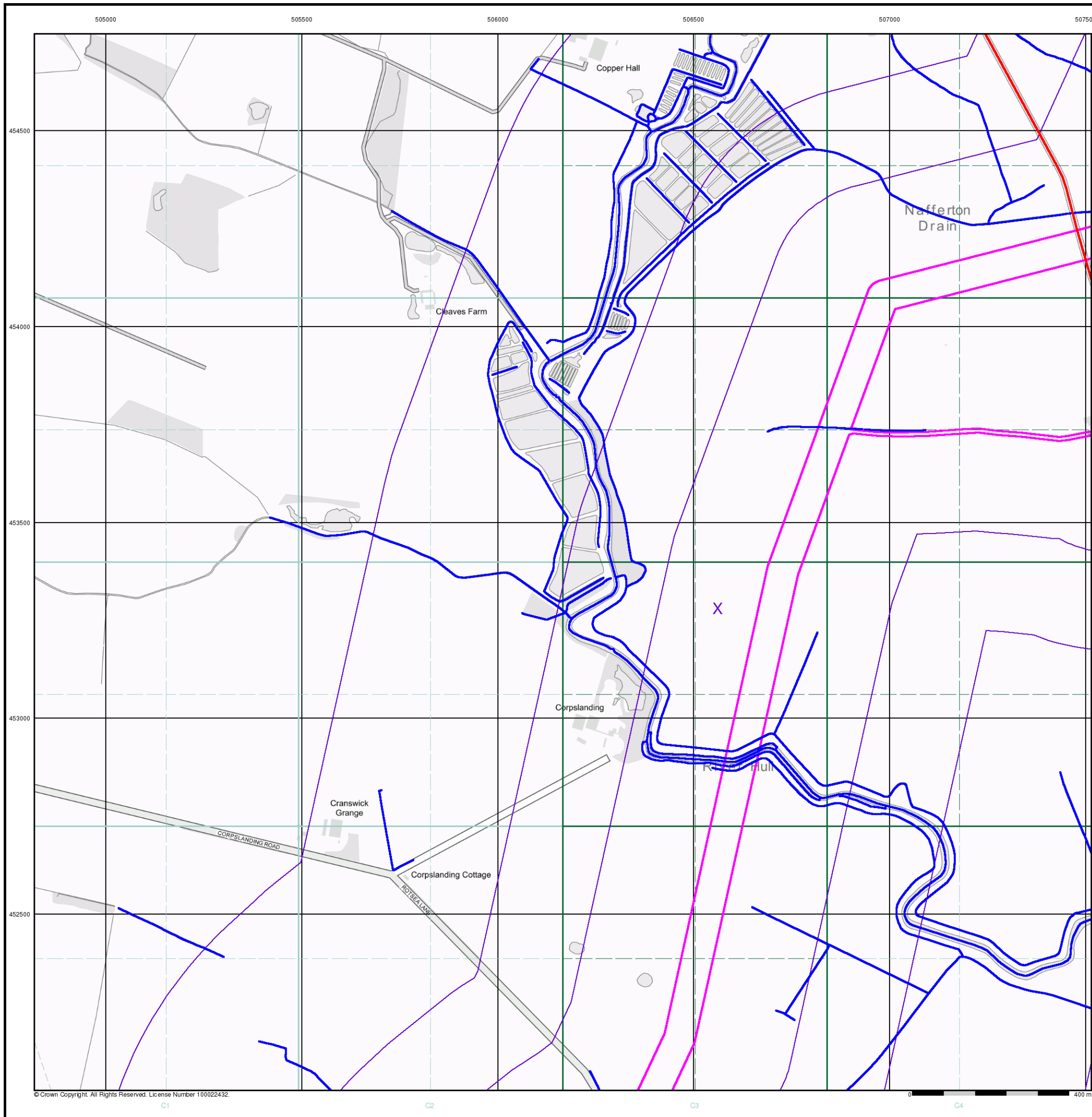

© Crown Copyright. All Rights Reserved. License Number 100022432.

General

- ◆ Specified Site
- Specified Buffer(s)
- X Bearing Reference Point
- Map ID
- Several of Type at Location

Agency and Hydrological

- Contaminated Land Register Entry or Notice (Location)
- ◆ Contaminated Land Register Entry or Notice
- ◇ Discharge Consent
- ▲ Enforcement or Prohibition Notice
- ▲ Integrated Pollution Control
- Integrated Pollution Prevention Control
- Local Authority Integrated Pollution Prevention and Control
- ▲ Local Authority Pollution Prevention and Control
- ▼ Local Authority Pollution Prevention and Control Enforcement
- Pollution Incident to Controlled Waters
- ▼ Prosecution Relating to Authorised Processes
- ◆ Prosecution Relating to Controlled Waters
- ▲ Registered Radioactive Substance
- + River Network or Water Feature
- + River Quality Sampling Point
- + Substantiated Pollution Incident Register
- ◆ Water Abstraction
- ◆ Water Industry Act Referral

Waste

- ▼ BGS Recorded Landfill Site (Location)
- ◆ BGS Recorded Landfill Site
- EA Historic Landfill (Buffered Point)
- EA Historic Landfill (Polygon)
- ▲ Integrated Pollution Control Registered Waste Site
- Licensed Waste Management Facility (Landfill Boundary)
- Licensed Waste Management Facility (Location)
- Local Authority Recorded Landfill Site (Location)
- Local Authority Recorded Landfill Site
- Registered Landfill Site
- ▼ Registered Landfill Site (Location)
- Registered Landfill Site (Point Buffered to 100m)
- Registered Landfill Site (Point Buffered to 250m)
- Registered Waste Transfer Site (Location)
- Registered Waste Transfer Site
- Registered Waste Treatment or Disposal Site (Location)
- Registered Waste Treatment or Disposal Site

Geological

- ▼ BGS Recorded Mineral Site

Industrial Land Use

- ★ Contemporary Trade Directory Entry
- ★ Fuel Station Entry
- ✖ COMAH Site
- ✖ Explosive Site
- ✖ NIHS Site
- ✖ Planning Hazardous Substance Consent
- ✖ Planning Hazardous Substance Enforcement

Site Sensitivity Map - Slice C

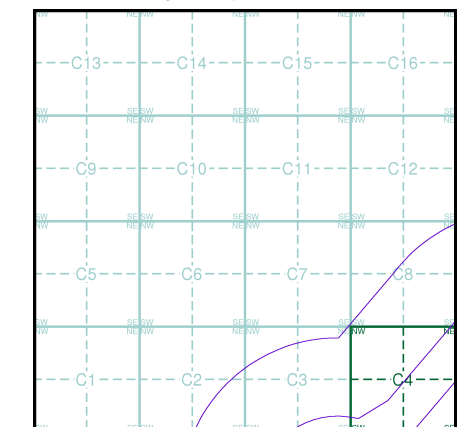

Order Details

Order Number: 201127555_1_1
 Customer Ref: PB8783-103-105
 National Grid Reference: 501460, 447610
 Slice: C
 Site Area (Ha): 62.79
 Search Buffer (m): 1000

Site Details

Hornsea Route

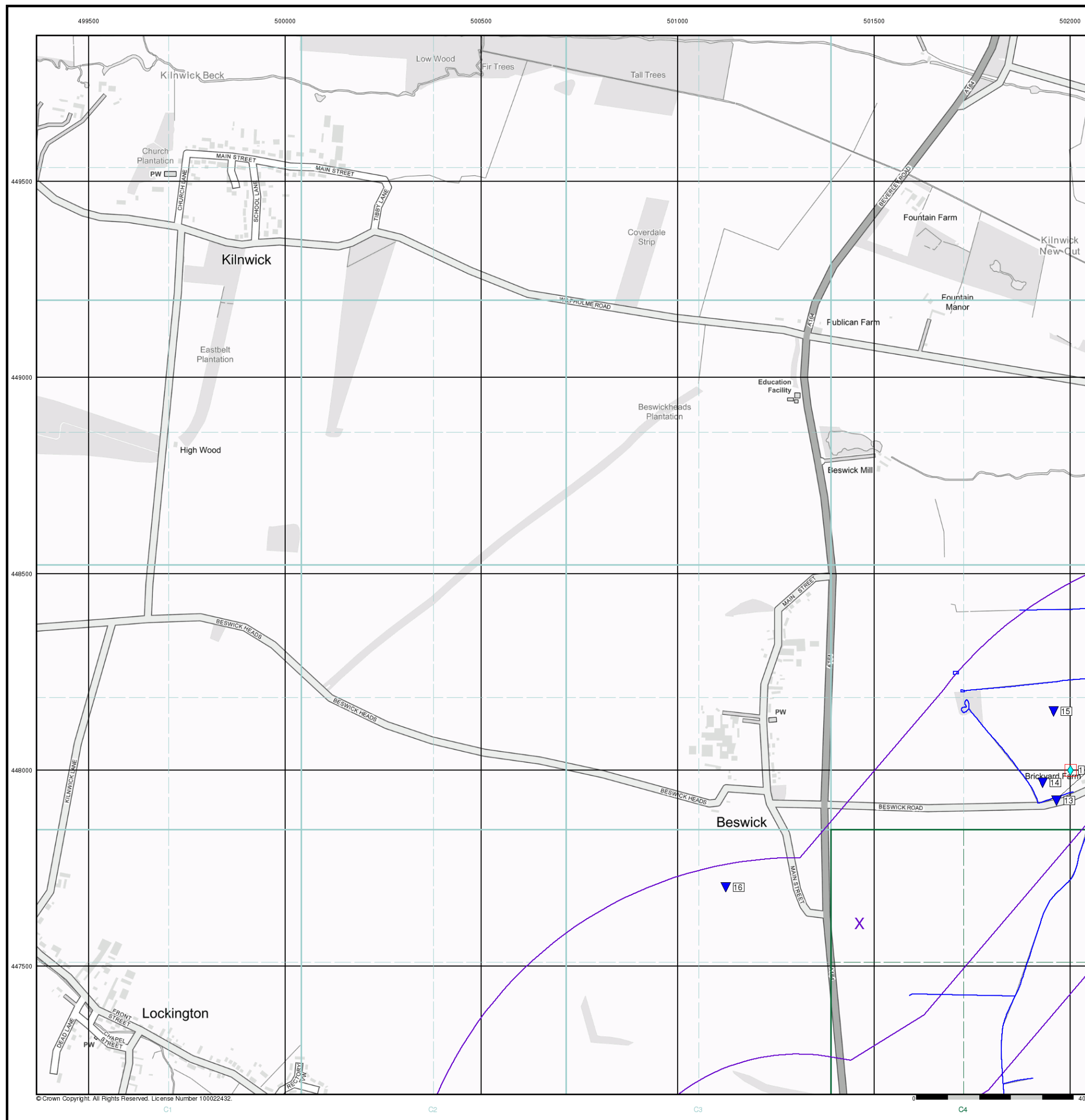





© Crown Copyright. All Rights Reserved. License Number 100022432.







Industrial Land Use Map

General

-  Specified Site
-  Specified Buffer(s)
-  Bearing Reference Point
-  Slice
-  Map ID

Industrial Land Use

-  Contemporary Trade Directory Entry
-  Fuel Station Entry
-  Gas Pipeline
-  Underground Electrical Cables

Industrial Land Use Map - Slice C

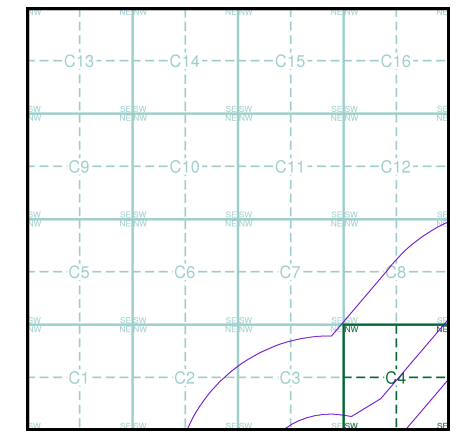



Order Details

Order Number: 201127555_1_1
 Customer Ref: PB8783-103-105
 National Grid Reference: 501460, 447610
 Slice: C
 Site Area (Ha): 62.79
 Search Buffer (m): 1000





Site Details

Hornsea Route

General

-  Specified Site
-  Specified Buffer(s)
-  Bearing Reference Point

Agency and Hydrological (Flood)

-  Extreme Flooding from Rivers or Sea without Defences (Zone 2)
-  Flooding from Rivers or Sea without Defences (Zone 3)
-  Area Benefiting from Flood Defence
-  Flood Water Storage Areas
-  Flood Defence

Flood Map - Slice C

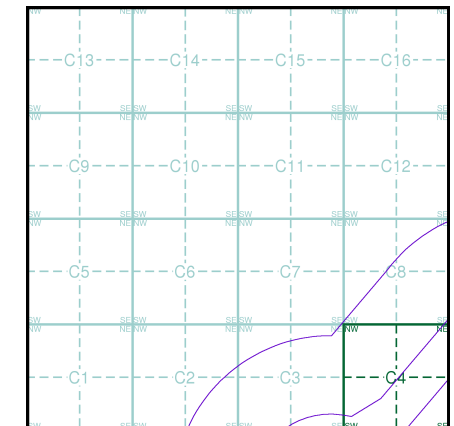

Order Details

Order Number: 201127555_1_1
 Customer Ref: PB8783-103-105
 National Grid Reference: 501460, 447610
 Slice: C
 Site Area (Ha): 62.79
 Search Buffer (m): 1000





Site Details

Hornsea Route







© Crown Copyright. All Rights Reserved. License Number 100022432.

General

-  Specified Site
-  Specified Buffer(s)
-  Bearing Reference Point
-  Map ID
-  Several of Type at Location

Agency and Hydrological (Boreholes)

-  BGS Borehole Depth 0 - 10m
-  BGS Borehole Depth 10 - 30m
-  BGS Borehole Depth 30m +
-  Confidential
-  Other

For Borehole information please refer to the Borehole .csv file which accompanied this slice.

A copy of the BGS Borehole Ordering Form is available to download from the Support section of www.envirocheck.co.uk.

Borehole Map - Slice C

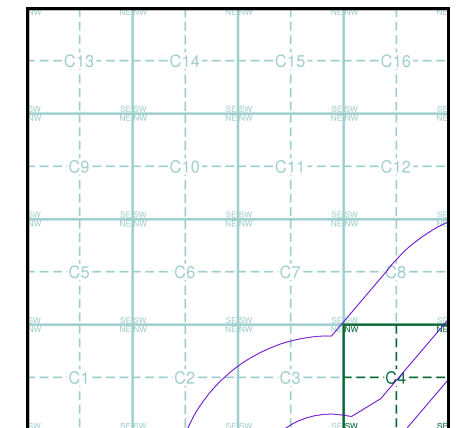

Order Details

Order Number: 201127555_1_1
 Customer Ref: PB8783-103-105
 National Grid Reference: 501460, 447610
 Slice: C
 Site Area (Ha): 62.79
 Search Buffer (m): 1000

Site Details

Hornsea Route



© Crown Copyright. All Rights Reserved. License Number 100022432.